

G R A P A S





INDICE GENERAL

	<u>Págs.</u>
TORNILLOS rosca chapa.....	13 02
TORNILLOS para plástico.....	13 02
TORNILLOS rosca métrica.....	13 03
UNIVERSALES.....	13 05
CLIPS METALICOS.....	13 06
TACOS PLASTICOS.....	13 10
REMACHES PLASTICOS.....	13 14
BOTONES FIJACION.....	13 30
VARIOS.....	13 34
ABRAZADERAS.....	13 35
TUBOS EMPALMES.....	13 36
EXPOSITORES.....	13 37
B.M.W.....	13 39
CHEVROLET / DAEWOO.....	13 48
CHRYSLER / DODGE / JEEP.....	13 49
DAIATSU.....	13 49
DACIA.....	13 50
FIAT (ALFA ROMEO / FIAT / LANCIA).....	13 52
FORD.....	13 72
HONDA.....	13 86
HYUNDAI / KIA.....	13 90
LEXUS.....	13 92
MAZDA.....	13 94
MERCEDES.....	13 96
MINI.....	13 106
MITSUBISHI.....	13 110
NISSAN.....	13 112
OPEL.....	13 114
P.S.A. (PEUGEOT / CITROEN).....	13 124
RENAULT.....	13 144
ROVER / LAND ROVER.....	13 166
SEAT (antiguos).....	13 168
SMART.....	13 172
SUBARU.....	13 173
SUZUKI.....	13 174
TOYOTA.....	13 176
V.A.G. (AUDI / SEAT / SKODA / VW).....	13 184
VOLVO.....	13 212
REMACHADORA.....	13 215
INDICE REFERENCIAS.....	13 216

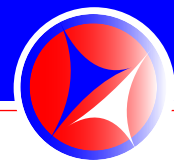

Familia 0300

TORNILLOS rosca chapa



Familia 0300

TORNILLOS para plástico

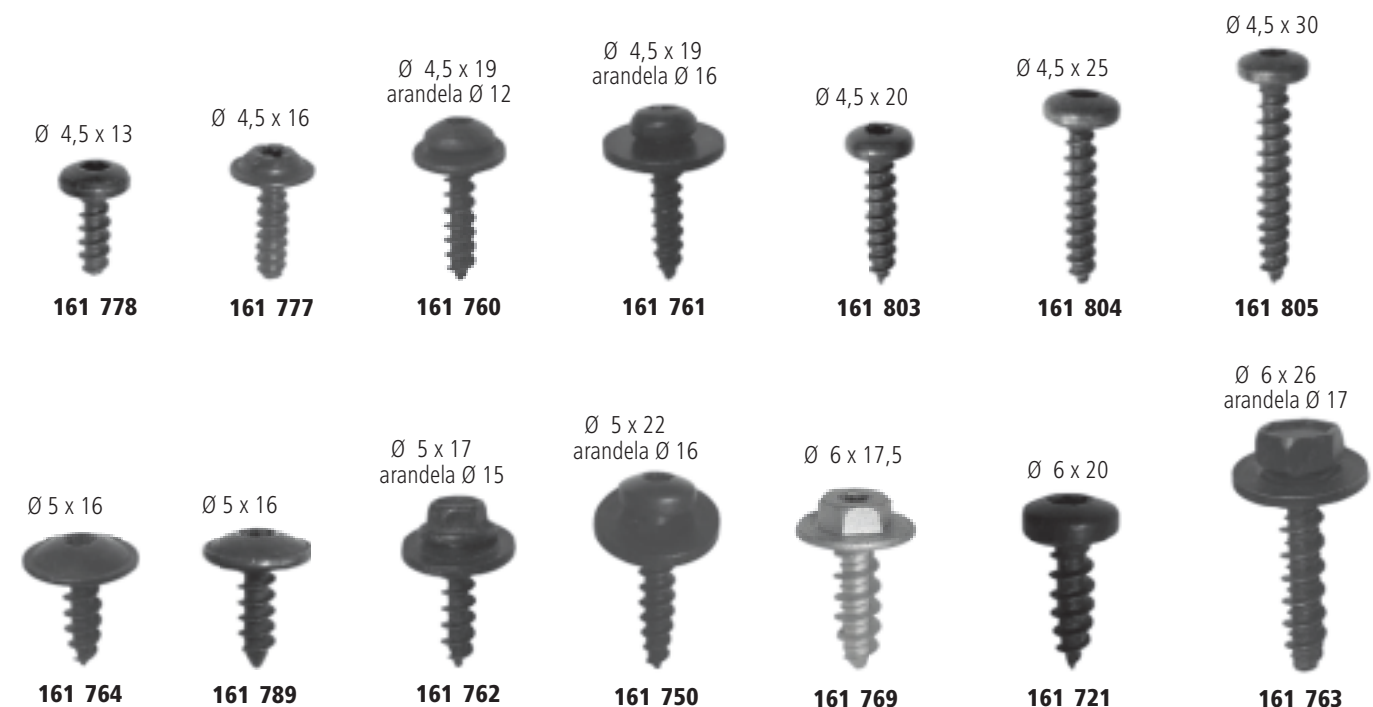



TORNILLOS rosca métrica

Familia 0300

Ø M5 x 11



161 758

Ø M6 x (10+21)



161 458

Ø M6 x 12
arandela Ø 18



161 798

Ø M6 x 13



161 733

Ø M6 x 16
arandela Ø 15



161 475

Ø M6 x 17



162 528

Ø M6 x 17,5



161 732

Ø M6 x 18



162 529

Ø M6 x 18



161 752

Ø M6 x 18
arandela Ø 18



161 730

Ø M6 x 19



161 486

Ø M6 x 20



161 456

Ø M6 x 20



161 457

Ø M6 x 20



161 706

Ø M6 x 20
arandela Ø 18



161 727

Ø M6 x 20
arandela Ø 22



161 724



TORNILLOS rosca métrica

Familia 0300

Ø M6 x 21



161 430

Ø M6 x 22
(cabeza 20 x 20)



162 356

Ø M6 x 22



162 526

Ø M6 x 25
arandela Ø 18



161 723

Ø M6 x 25
(En jaula móvil)



161 450

Ø M6 x 27



162 397

Ø M6 x 28
arandela Ø 24



161 731

Ø M7 x 15



161 728

Ø M8 x 10,5
arandela Ø 17



161 754

Ø M8 x 16



162 363

Ø M8 x 18
(cabeza 20 x 20)



162 357

Ø M8 x 20



161 476

Ø M8 x 20



161 705

Ø M8 x 20



161 455

Ø M8 x 22



162 619

Ø M8 x 26,5



161 729

Ø M8 x 30



161 440



UNIVERSALES

Familia 0300

Grapas Tapizados	REF.	
	161 472	2,5 mm.
	161 415	2,7 mm.
	162 600	3 mm.
	161 468	4 mm.

Grapas NP-NR-SNP	REF.	
	161 469	2,5 mm.
	161 412	3 mm.
	161 413	3,5 mm.
	161 414	4 mm.

Tuercas C-4800	REF.	
	162 625	Ø M-4
	162 626	Ø M-5
	162 627	Ø M-6
	162 628	Ø M-7
	162 629	Ø M-8

Tuercas DIN 6923	REF.	
	162 588	Ø M-5
	162 589	Ø M-6
	162 590	Ø M-8

Tuercas C-4830	REF.	
	162 413	Ø M-4
	162 925	Ø M-5
	162 414	Ø M-6
	162 585	Ø M-7
	162 415	Ø M-8

... con arandela móvil	REF.	
	162 711	Ø M-6
	162 712	Ø M-8

Tuercas enjauladas	REF.	
	161 467	Ø M-6

DESCRIPCION	REF.	
Fijac. metálica universal pasoruedas y varios	161 483	Ø cabeza : 15 mm Ø agujero : 7 mm
		

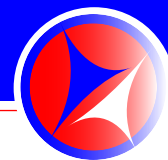





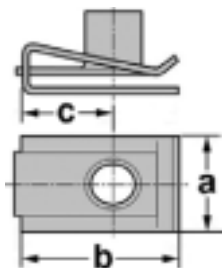



CLIPS METALICOS



Familia 0300



Ø = diámetro tornillo
 a x b = medidas exteriores
 c = distancia eje fijación

	REF.	Ø	a x b (c)
	161 701	M-4	10 x 15 (8,5)
	161 703	M-5	10 x 15 (8,5)
	162 444	M-5	14 x 20 (12)
	161 813	M-5	16 x 19 (10)
	161 438	M-6	15 x 22 (12,5)
	162 442	M-6	15 x 22 (13)
	161 497	M-6	16 x 24 (14)
	161 464	M-6	16,3 x 19 (10)

	REF.	Ø	a x b (c)
	161 499	M-8	16,7 x 25 (15,5)
	161 812	M-8	18,3 x 25 (14)

especial «oval»	REF.	Ø	a x b (c)
	161 815	M-5 oval	15,1 x 21 (12)
	161 740	M-6 oval	16 x 24 (13)



CLIPS METALICOS

Familia 0300

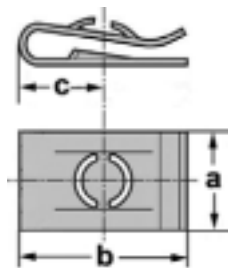

\emptyset = diámetro tornillo
 a x b = medidas exteriores
 c = distancia eje fijación

	REF.	\emptyset	a x b (c)
	161 487	2,9	8 x 10 (4,8)
	161 447	2,9	9 x 16,5 (10)
	161 757	2,9	10,8 x 13 (7)
	162 591	3,5	9 x 12 (7,5)
	161 409	3,5	11 x 16 (8,5)
	161 426	3,5	12 x 15 (9)
	161 490	3,9	11,2 x 16 (8)
	161 741	4,2	11 x 13 (6,5)
	161 418	4,2	11 x 13 (7)

	REF.	\emptyset	a x b (c)
	161 493	4,2	11 x 15,5 (7,5)
	161 736	4,2	11 x 16,2 (8)
	161 484	4,2	11 x 16,2 (9)
	162 635	4,2	11 x 16,5 (8)
	161 492	4,2	11 x 16,5 (8,5)
	161 410	4,2	11 x 18 (9)
	161 488	4,2	11,6 x 15 (8)
	161 744	4,2	12 x 16,2 (8,5)
	161 427	4,2	15 x 20 (8,5)
	161 495	4,8	11 x 16,5 (8,5)
	161 788	4,8	11,1 x 16,5 (8)



CLIPS METALICOS





Familia 0300



	REF.	Ø	a x b (c)		REF.	Ø	a x b (c)
	161 738	4,8	11,2 x 16,5 (9)		161 749	4,8	18,5 x 21,5 (12)
	161 839	4,8	11,2 x 16,7 (8,5)		161 806	4,8	15 x 20,5 (11)
	161 496	4,8	12 x 15 (7)		161 840	4,8	16 x 19 (12)
	161 411	4,8	12 x 15 (8)		161 748	4,8	22 x 25,5 (15)
	161 737	4,8	12,5 x 16,5 (9,5)		161 746	5,5	14,5 x 25,8 (17,5)
	161 787	4,8	13,1 x 18,5 (10)		161 771	5,5	14,6 x 24,2 (20)
	161 498	4,8	15 x 16 (9)		161 745	5,5	15,8 x 23,6 (13)
	161 800	4,8	11 x 16,1 (8)		161 704	5,6	13,2 x 21 (12)
	161 491	4,8	16,2 x 19 (11)		161 437	6,3	14 x 30 (18,5)
	161 702	4,8	16,3 x 19,3 (12)				
	161 801	4,8	14,5 x 18 (11)				



CLIPS METALICOS

Familia 0300

	REF.	Ø	a x b (c)
	161 449	6,3	15 x 23 (14)
	161 436	6,3	16 x 31,2 (22,5)
	162 479	6,3	16 x 20,2 (11)
	161 747	6,3	16,2 x 24,8 (14)

	REF.	Ø	a x b (c)
	161 756	6,3	16,5 x 26,5 (14)
	161 465	6,3	17,2 x 23 (14)
	162 634	6,3	18,2 x 16,5 (9)

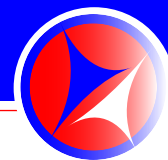

TACOS PLASTICOS

Familia 0300

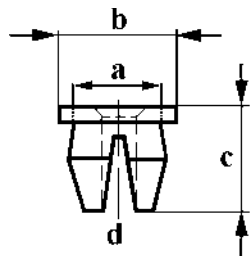

$\varnothing a$ = diámetro taladro
 $\varnothing b$ = diámetro cabeza
 c = altura fijación
 $\varnothing d$ = diámetro agujero para tornillo

	REF.	$\varnothing a$	$\varnothing b$	c	$\varnothing d$
	163 219	8	11	16	3,9
	162 242	8	11	17	3,5
	162 243	10	14	19	4,8
	162 457	11	15	19	5
	163 063	6x15	11x21	17	3,5
	162 851	6,7x12,9	9,6x16,1	11,9	2,9
	163 767	7x11,7	9x14,5	12	4,2
	162 902	7x12	9x15	10	4,2

	REF.	$\varnothing a$	$\varnothing b$	c	$\varnothing d$
	162 523	7x13	10x16	10	4,2
	163 502	7x14	9x15	10	3,9
	163 350	7x14	9x15	10	4,2
	163 881	7x14	9,5x15	10	2,9
	162 892	7x14	11x18	12	3,9
	163 222	7x14	13x20	17,2	3,9
	162 483	7x14	13x20	17	4,2
	162 888	7x15	10x18	10	4,2
	163 882	7x15	14x20	17	3,9
	164 062	7,5x10,5	12,2x17	16	2,9
	163 298	7,5x11,4	9,5x16,6	11	2,9



Familia 0300

TACOS PLASTICOS

	REF.	Ø a	Ø b	c	Ø d
	164 101	8x11,6	15x19	17,2	5,5
	162 326	6	9,5	7,5	2,5
	162 842	6x6,5	10	7	2,5
	162 963	6,7	9	9,5	3,9
	162 245	6x7	15	9	3,5
	164 134	6,7x7,4	9,3	12,5	4,2
	162 240	7	9	10	3,5
	163 181	7	9	12	3,5
	162 715	7	9	12	4,2
	162 238	7	9,5	9	3
	162 237	7	9,5	9	3,5
	164 129	7	9,5	11,8	4,5
	164 065	7	9,5	14,9	4,8
	163 172	7	10	8,5	4,2
	162 609	7	10	10	3

	REF.	Ø a	Ø b	c	Ø d
	162 817	7	10	13	3,5
	162 717	7	10	16	3,5
	162 401	7	11	13	3
	162 776	7	11	14	3,5
	162 331	7	11	14	4
	162 775	7	12	17	4
	164 438	7	12	17	5
	162 244	7	13	9	4,2
	163 281	7	13	16	3,9
	163 611	7	14	21	4,2
	163 498	7	16	10	4,8
	163 426	7,2	9	9	3,5



Familia 0300

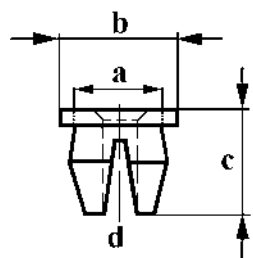

- Ø a = diámetro taladro
- Ø b = diámetro cabeza
- c = altura fijación
- Ø d = diámetro agujero para tornillo





















TACOS PLASTICOS

	REF.	Ø a	Ø b	c	Ø d		REF.	Ø a	Ø b	c	Ø d
	164 142	7x7,3	12	15	4,8		164 124	8	15,7	20	4
	162 774	7x7,5	7x12	12	3,5		163 894	8	16	17,5	5,5
	164 168	7,5x8,3	10	11,4	4,8		163 051	8	16	19	4,8
	164 061	7,7	12,7	10	4,2		162 368	8	18	14	5
	162 534	8	11	13	4,5		164 079	8x8,5	11	9	4,2
	163 275	8	12	9	5,5		162 955	8x10	20	12,5	5,5
	163 427	8	13	12	4,2		163 439	8,2	11	12	4,2
	163 211	8	14	10	5,5		162 985	8,2	12	11,9	4,2
	163 883	8	14	16,5			164 352	8,1x8,5	16,9	13,3	6
	162 903	8	15,5	17	4		162 649	8,5	11,5	11	4
							163 484	8,5	15	10	5,5



Familia 0300

TACOS PLASTICOS

	REF.	Ø a	Ø b	c	Ø d		REF.	Ø a	Ø b	c	Ø d
	163 519	8,5	17	10	5,5		162 480	9,5	22	21	4,8
	163 689	8,5	18	19,5	4,2		163 180	9,5x14	20	14	4,8
	163 192	8,5x10,5	13,4x15,3	10,2	5,5		163 538	10	12	11,5	4,8
	164 290	9x11	14,2x16,2	11,8	5,5		162 241	10	13	13	3,5
	163 256	9	17	11	5,5		162 928	10	13	20	4,8
	163 165	9	20	18	5,5		162 718	10	13	20	5,5
	164 091	9	20	24	5,5		162 545	10	14	15	4
	163 622	9	20,5	11,5	5,5		163 274	10	16	10	5,5
	163 367	9,5	13	21	6,35		164 078	10,7	15,3	14	4,5
	163 505	9,5	13,5	19,5	4,8		162 811	10x13	13x14	19	5,5
							163 377	10,8x11,2	16	12	6,35

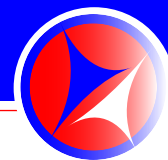





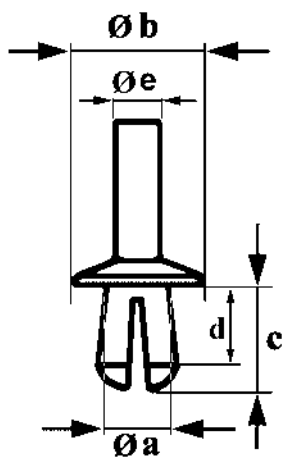









REMACHES PLASTICOS

Familia 0300



- Ø a = diámetro agujero
- Ø b = diámetro cabeza
- c = altura total fijación
- d = altura fijación
- Ø e = diámetro espiga

















	REF.	Ø a	Ø b	c(d)	Ø e
	162 431	3,5	8	7 (6)	2,1
	163 717	4	7,8	8,5 (7)	2
	162 664	4,5	7	7 (5,1)	4,2
	164 118	4,7	15,2	11,5 (9)	3
	164 287	5	8,5X12	9 (6)	2,9
	163 926	5	9	7 (5,5)	3

	REF.	Ø a	Ø b	c(d)	Ø e
	163 910	5	10	7,5 (5,5)	3
	164 257	5	10	10,5 (9)	3
	164 110	5	10	11 (9)	3
	163 329	5	10	11 (9)	3,2
	164 396	5	10	12 (9)	2,8
	162 259	5	10	15,8 (12)	2,9
	162 647	5	11,3	6,7 (5,3)	3,2
	163 792	5	12	11 (8,2)	3



Familia 0300

REMACHES PLASTICOS

	REF.	Ø a	Ø b	c(d)	Ø e		REF.	Ø a	Ø b	c(d)	Ø e
	164 275	5	15,2	11,5 (9,5)	3		164 056	5,7	16	10 (8)	3,4
	162 456	5,5	9,4	10,8 (8,2)	3,2		164 286	5,8	20	14 (9)	3,8
	163 793	5,5	12	11 (9,5)	3		162 819	6	10	11,5 (9,1)	3,2
	163 299	5,5	16	10 (8)	3,5		162 821	6	10	12 (9)	4
	163 303	5,5	16	10 (8)	3,5		164 274	6	10	12 (9,5)	3,5
	163 305	5,5	16	11 (7,5)	3		162 519	6	10	18 (9)	4,7
	163 056	5,5	10x12	10 (6,4)	4x5		163 961	6	11	10 (8,3)	3,9
	164 415	5,7	11	20 (2)	3,5		164 228	6	11,8x18	10 (7,5)	4





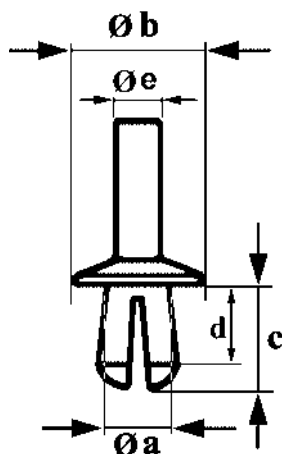









Familia 0300



- Ø a = diámetro agujero
- Ø b = diámetro cabeza
- c = altura total fijación
- d = altura fijación
- Ø e = diámetro espiga













REMACHES PLASTICOS

	REF.	Ø a	Ø b	c(d)	Ø e
	163 295	6	15	12,5 (7,5)	3,8
	163 270	6	15	13,5 (9)	4
	163 044	6	15	15 (12)	3,6
	163 047	6	15	20 (17)	3,5
	164 253	6	15	20 (17)	3,4
	163 810	6	15	22,5 (13)	3,9
	163 485	6	12	9 (8)	3,5
	163 140	6	12	13 (8)	3,9
	163 487	6	12	14 (13)	3,5
	162 624	6	13	9,2 (7,8)	3,9
	164 084	6	14	17 (11)	4
	163 271	6	15	11 (9)	4



Familia 0300

REMACHES PLASTICOS

	REF.	Ø a	Ø b	c(d)	Ø e		REF.	Ø a	Ø b	c(d)	Ø e
	163 054	6	16	10 (7)	3,9		163 045	6	20	15 (12)	3,6
	163 198	6	16	14 (12)	3,4		164 255	6	20	17 (13)	3,8
	163 235	6	16	10 (15)	3,9		163 048	6	20,5	20 (17)	3,4
	164 353	6	18	13 (7,5)	3,5		163 291	6x6	7x15	13 (7,4)	4
	164 236	6	18	16 (11,5)	3,5		162 852	6x6	8x15	12 (8,6)	4
	163 068	6	20	14 (10)	3,5		163 210	6x8	16	(9)	4
	163 046	6	20	14 (12)	3,6						

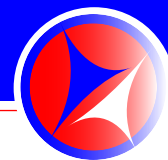



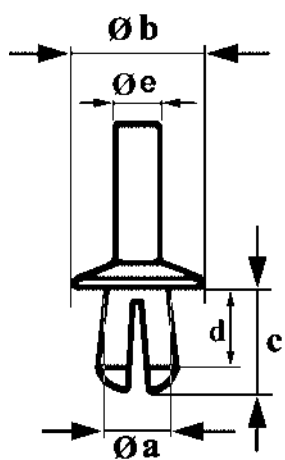











Familia 0300



$\varnothing a$ = diámetro agujero
 $\varnothing b$ = diámetro cabeza
 c = altura total fijación
 d = altura fijación
 $\varnothing e$ = diámetro espiga

REMACHES PLASTICOS















	REF.	$\varnothing a$	$\varnothing b$	c(d)	$\varnothing e$
	163 486	6,2	10	9 (8)	3,6
	162 389	6,2	11	10 (8)	4
	162 481	6,2	12	9 (7)	3,3
	162 424	6,2	12,2	11 (7,4)	4
	163 168	6,2	14	11,5 (9)	4
	162 957	6,2	16	17 (10)	4

	REF.	$\varnothing a$	$\varnothing b$	c(d)	$\varnothing e$
	163 328	6,2	17	9	4
	164 126	6,2	17	15 (12,2)	3,9
	163 442	6,2	17	17 (11)	3,5
	163 169	6,2	18	11 (7)	4
	162 906	6,2	20	10 (7,4)	4
	163 206	6,5	10x22	7,2 (3,5)	4
	162 666	6,5	10x22	9 (3,7)	4
	164 022	6,5	15x22	16,5 (14)	3,5



Familia 0300

REMACHES PLASTICOS

	REF.	Ø a	Ø b	c(d)	Ø e		REF.	Ø a	Ø b	c(d)	Ø e
	163 392	6,5	15	8 (8)	3,5		163 389	6,5	16	11 (9)	4
	162 258	6,5	15	11 (9)	4		163 301	6,5	16	13	10
	163 475	6,5	15	13 (8)	4,3		164 313	6,5	17,5	22,5 (13)	3,8
	163 300	6,5	15	13	5		164 256	6,5	18	20 (9,5)	3x5,9
	163 859	6,5	15	17	4,5		163 070	6,5	19	8,6 (5,6)	3,3
	164 406	6,5	15,3	19 (11,5)	3,5x5		163 757	6,5	20	11,2 (8,5)	3,9
	163 640	6,5	16	11 (8)	3,8		163 610	6,5	20	20 (18)	3,4







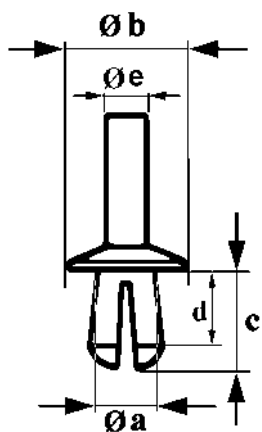







REMACHES PLASTICOS

Familia 0300



- Ø a = diámetro agujero
- Ø b = diámetro cabeza
- c = altura total fijación
- d = altura fijación
- Ø e = diámetro espiga















	REF.	Ø a	Ø b	c(d)	Ø e
	162 979	6,5	22	14 (10)	3,5
	163 735	6,5	17,5	9,5 (6)	4
	164 189	6,8	16	8 (5,8)	3,5
	163 249	6,8	17	6 (5,3)	4,4
	164 187	6,8	18,5	12 (9,5)	5
	164 099	6,8	19	10 (8,5)	4,6

	REF.	Ø a	Ø b	c(d)	Ø e
	164 052	6,9x6,7	16	17 (6,5)	4
	164 060	7	13,9	15 (12,5)	4,5
	164 087	7	17	8,5 (6,5)	4
	163 269	7	17	10 (8)	5
	163 530	7	18	8 (8)	5
	162 505	7	18	17 (13)	4
	164 261	7	18	17 (13)	4



Familia 0300

REMACHES PLASTICOS

	REF.	Ø a	Ø b	c(d)	Ø e		REF.	Ø a	Ø b	c(d)	Ø e
	164 043	7	18	17,5 (7)	3x6		163 125	7	11x18	13 (5)	3x3
	163 128	7	19,5	16 (7)	4		162 812	7x7	11	10 (5)	4
	163 302	7	20	8 (6)	10		164 100	7	18,6	22 (15)	3,9
	163 476	7	20	10 (9)	5		163 020	7x8	10x12	7,7 (5)	3,6
	163 529	7	20	11 (9)	5		163 369	7,2	20	14 (12)	4,7
	164 024	7	20	11 (9)	5		164 193	7,5	12,6	12,3 (10,5)	5,4
	163 167	7	20	11	6		164 153	7,5	16	13 (9)	6,4
	163 827	7	20	11,5 (8,5)	4						







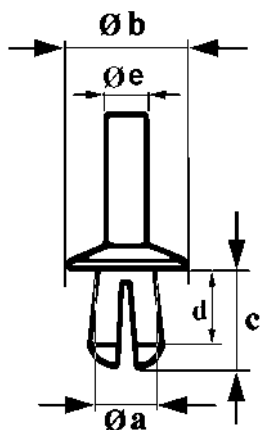







REMACHES PLASTICOS

Familia 0300



- Ø a = diámetro agujero
- Ø b = diámetro cabeza
- c = altura total fijación
- d = altura fijación
- Ø e = diámetro espiga













	REF.	Ø a	Ø b	c(d)	Ø e
	164 258	7,5	25	25 (11)	4,5x6
	164 156	7,6	19,8	18 (9)	5,8
	164 055	7,8	20	12 (7,5)	5,5
	162 632	8	12	11 (7)	5
	162 665	8	12x17	9,6 (6)	5
	164 192	8	12,6	12,5 (10,8)	5,4
	164 063	8	12,8	12,2 (10,5)	5,4

	REF.	Ø a	Ø b	c(d)	Ø e
	164 299	7,5	16,8	15,5 (10,5)	4,8
	163 794	7,5	17	14,5 (8)	4
	163 813	7,5	18	18,5 (13,5)	5,5
	164 155	7,5	19,7	10 (8)	6
	163 743	7,5	21,7	13 (10,5)	5,5



Familia 0300

REMACHES PLASTICOS

	REF.	Ø a	Ø b	c(d)	Ø e		REF.	Ø a	Ø b	c(d)	Ø e
	163 927	8	13	15 (12)	4		162 373	8	16	12,5 (8)	4,9
	162 843	8	14	11 (7)	4		163 304	8	16	14 (10)	4,7
	163 036	8	14	12 (7)	4x4		163 503	8	18	12 (10)	6
	164 097	8	14,8	10,8 (9)	3,9		163 166	8	18	14 (7,6)	6x7
	163 922	8	15,3	13 (8)	5,5		162 517	8	18	18 (14)	4,8
	163 923	8	15,3	13 (8)	5,5		163 889	8	19	15,2 (12)	5
	163 307	8	16	11 (6)	5						







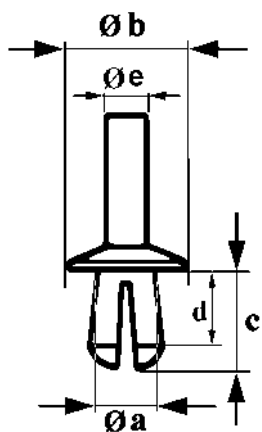







REMACHES PLASTICOS

Familia 0300



- Ø a = diámetro agujero
- Ø b = diámetro cabeza
- c = altura total fijación
- d = altura fijación
- Ø e = diámetro espiga













	REF.	Ø a	Ø b	c(d)	Ø e
	164 314	8	20	9 (7)	6
	163 171	8	20	10 (6,4)	5,3
	164 230	8	20	12 (9)	5,6
	163 277	8	20	12,5 (7)	5x5
	163 344	8	20	13 (8)	3x6
	163 482	8	20	13 (8)	6x7
	163 085	8	20	13,5 (8)	3,9

	REF.	Ø a	Ø b	c(d)	Ø e
	163 918	8	19	17 (9,5)	7x4
	164 161	8	19,5	10 (6)	5,5
	163 014	8	20	8,5 (5,4)	4
	163 074	8	20	9 (6)	5
	163 035	8	20	9 (6)	6



REMACHES PLASTICOS

Familia 0300

	REF.	Ø a	Ø b	c(d)	Ø e		REF.	Ø a	Ø b	c(d)	Ø e
	163 069	8	20	13,5 (11)	4,9		164 371	8	20	21 (13)	3,8x7,3
	163 409	8	20	14 (13)	5		163 306	8	22	13 (10)	4,4
	163 815	8	20	15 (11)	5x5		162 260	8	24	16 (11)	5
	163 384	8	20	15 (7)	6		163 734	8	25	24,5 (14)	6,2x4
	163 448	8	20	16 (11)	7		163 780	8	30	16 (8,5)	5
	163 278	8	20	20 (11)	5,8		162 765	8x8	16	14 (10)	5,5
	163 091	8	20	21 (12)	5x7						



REMACHES PLASTICOS

Familia 0300

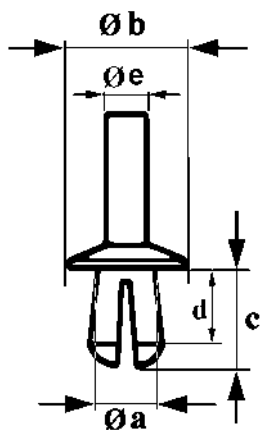











- Ø a = diámetro agujero
- Ø b = diámetro cabeza
- c = altura total fijación
- d = altura fijación
- Ø e = diámetro espiga

	REF.	Ø a	Ø b	c(d)	Ø e		REF.	Ø a	Ø b	c(d)	Ø e
	164 122	8x9	9,7x12,7	8,5 (5)	7x5		163 925	8,5	12	10 (7)	4,9
	162 958	8x10	12	15 (4,5)	5		163 981	8,5	15	27 (13)	5,2
	162 766	8x10	24	13 (10)	5		162 341	8,5	16	13 (8)	4
	163 088	8,2	18	14 (10)	4		163 474	8,5	18	11 (8)	6
	164 254	8,2	18	18 (12)	4,3x5,7		163 390	8,5	18	12 (8)	5,8



Familia 0300

REMACHES PLASTICOS

	REF.	Ø a	Ø b	c(d)	Ø e		REF.	Ø a	Ø b	c(d)	Ø e
	163 391	8,5	18	12 (8)	5,8		163 296	9	15	26 (16)	5,3
	164 085	8,5	18	16 (10,5)	7		163 756	9	16	12	6,7
	163 963	8,5	18	19 (14,8)	4,8		164 416	9	17,8	19 (14,5)	4,9
	163 127	8,5	20	11 (4,4)	4x4		163 358	9	18	27 (19)	7x8
	164 107	8,5	20	14 (12)	4,9		163 297	9	20	27 (17)	5,5
	163 924	8,5	25	13,5 (10,5)	6						



Familia 0300

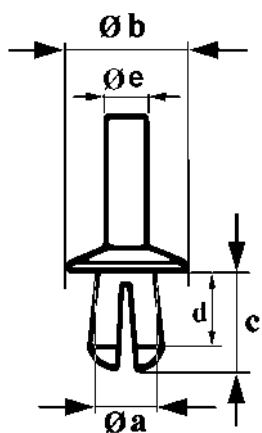

- Ø a = diámetro agujero
- Ø b = diámetro cabeza
- c = altura total fijación
- d = altura fijación
- Ø e = diámetro espiga

REMACHES PLASTICOS





	REF.	Ø a	Ø b	c(d)	Ø e
	164 312	9	22	15 (13)	7
	164 179	9,5	19,8	26,5 (16)	7,8
	164 073	9,5	22	7,5 (4)	7,2
	164 086	9,5	20,2x30	20 (15)	7,8
	164 157	9,7	19,4	15,5 (13,5)	8,10



	REF.	Ø a	Ø b	c(d)	Ø e
	164 154	9,7	19,7	11,5 (9,5)	8
	164 177	9,8	20	16,5 (11)	6,5
	164 178	9,8	20	20,5 (13)	6,5
	163 276	10	18	18 (13)	8x10
	163 037	10	20	14 (11)	7
	163 164	10	20	15 (11)	8x9
	164 292	10	20	16 (8)	6



Familia 0300

REMACHES PLASTICOS

	REF.	Ø a	Ø b	c(d)	Ø e
	163 802	10	20	20 (15,5)	8x8
	163 163	10	20	25 (15)	7
	164 315	10	20x30	13,5 (8,5)	7,8
	164 051	11	16	13 (8)	6,5
	162 425	11	25	14 (8)	7

	REF.	Ø a	Ø b	c(d)	Ø e
	163 903	12	18	10 (6)	8
	163 973	14	25	21 (13)	8
	163 814	15	22	16 (12)	12



BOTONES FIJACION

Familia 0300

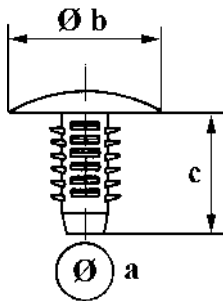

$\varnothing a$ = diámetro taladro
 $\varnothing b$ = diámetro cabeza
 c = altura fijación

$\varnothing a = 5,2$
 $\varnothing b = 16$
 $c = 26$

$\varnothing a = 5$
 $\varnothing b = 11$
 $c = 12$



163 086 negro



163 317 negro

$\varnothing a = 5,5$
 $\varnothing b = 11$
 $c = 12,5$



164 113 negro

$\varnothing a = 5,6$



164 169 negro

$\varnothing a = 6$
 $\varnothing b = 14$
 $c = 13$



163 678 negro

$\varnothing a = 6$
 $\varnothing b = 12$
 $c = 18$



162 883 blanco

$\varnothing a = 6$
 $\varnothing b = 13$
 $c = 18$



163 173 negro

$\varnothing a = 6$
 $\varnothing b = 15$
 $c = 17$



163 217 gris

$\varnothing a = 6$
 $\varnothing b = 22$
 $c = 21$



163 099 negro

$\varnothing a = 6,2$
 $\varnothing b = 30$
 $c = 14$



163 385 negro

$\varnothing a = 6,5$
 $\varnothing b = 12$
 $c = 14$



162 823 negro

$\varnothing a = 6,5$
 $\varnothing b = 12$
 $c = 18$



162 447 negro

$\varnothing a = 6,5$
 $\varnothing b = 13$
 $c = 15$



162 705 negro

$\varnothing a = 6,5$
 $\varnothing b = 15$
 $c = 16,5$



164 204 negro

$\varnothing a = 6,5$
 $\varnothing b = 18$
 $c = 15$



162 643 negro

$\varnothing a = 6,5$
 $\varnothing b = 18$
 $c = 17$



162 806 negro

$\varnothing a = 6,5$
 $\varnothing b = 18$
 $c = 17$



163 386 negro

$\varnothing a = 6,5$
 $\varnothing b = 19$
 $c = 15$



162 815 negro

$\varnothing a = 6,5$
 $\varnothing b = 20$
 $c = 12$



163 308 negro

$\varnothing a = 6,5$
 $\varnothing b = 20$
 $c = 13,5$



162 450 negro

$\varnothing a = 6,5$
 $\varnothing b = 20$
 $c = 16$



162 975 negro

$\varnothing a = 6,5$
 $\varnothing b = 21$
 $c = 19$



163 879 negro

$\varnothing a = 6,5$
 $\varnothing b = 24,5$
 $c = 11$



163 327 negro

$\varnothing a = 6,5$
 $\varnothing b = 30$
 $c = 16$



163 129 negro



BOTONES FIJACION

Familia 0300

$\emptyset a = 6,7$
 $\emptyset b = 20$
 $c = 14$



163 006
negro

$\emptyset a = 6,7$
 $\emptyset b = 20$
 $c = 14$



163 490
gris

$\emptyset a = 6,7$
 $\emptyset b = 30$
 $c = 17$



163 007
negro

$\emptyset a = 6,7$
 $\emptyset b = 30$
 $c = 17$



163 489
gris

$\emptyset a = 7$
 $\emptyset b = 12,5$
 $c = 17,5$



162 454
negro

$\emptyset a = 7$
 $\emptyset b = 14$
 $c = 16$



162 221
negro

$\emptyset a = 7$
 $\emptyset b = 14$
 $c = 16$



162 222
gris

$\emptyset a = 7$
 $\emptyset b = 14$
 $c = 16$



162 320
blanco

$\emptyset a = 7$
 $\emptyset b = 15$
 $c = 13$



162 493
negro

$\emptyset a = 7$
 $\emptyset b = 17$
 $c = 15,5$



163 890
negro

$\emptyset a = 7$
 $\emptyset b = 19$
 $c = 27$



163 878
negro

$\emptyset a = 7$
 $\emptyset b = 20$
 $c = 13$



162 908
negro

$\emptyset a = 7$
 $\emptyset b = 20$
 $c = 16$



162 660
negro

$\emptyset a = 7$
 $\emptyset b = 20$
 $c = 18$



162 935
negro

$\emptyset a = 7$
 $\emptyset b = 20$
 $c = 25$



163 742
negro

$\emptyset a = 7$
 $\emptyset b = 18,4$
 $c = 11$



164 109
negro

$\emptyset a = 7$
 $\emptyset b = 19$
 $c = 11$



162 453
negro

$\emptyset a = 7$
 $\emptyset b = 22$
 $c = 25$



162 657
negro

$\emptyset a = 7$
 $\emptyset b = 28$
 $c = 16$



163 079
negro

$\emptyset a = 7,2$
 $\emptyset b = 18$
 $c = 14$



163 174
negro

$\emptyset a = 7,5$
 $\emptyset b = 18$
 $c = 20,5$



164 375
negro

$\emptyset a = 7,5$
 $\emptyset b = 22$
 $c = 28$



164 376
negro

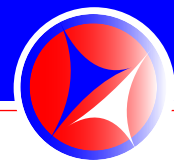





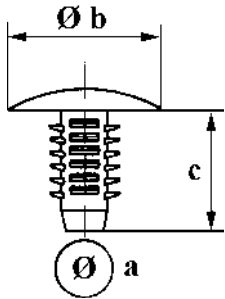







BOTONES FIJACION









Familia 0300









Ø a = diámetro taladro
 Ø b = diámetro cabeza
 c = altura fijación

<p>Ø a = 7,5 Ø b = 15 c = 17,5</p>  <p>162 200 gris</p>	<p>Ø a = 7,5 Ø b = 15 c = 17,5</p>  <p>162 201 marrón</p>	<p>Ø a = 7,5 Ø b = 15 c = 17,5</p>  <p>162 202 negro</p>	<p>Ø a = 7,5 Ø b = 15 c = 22,5</p>  <p>162 603 negro</p>
---	---	--	--

<p>Ø a = 7,5 Ø b = 17,8 c = 16</p>  <p>164 092 negro</p>	<p>Ø a = 7,5 Ø b = 18 c = 18</p>  <p>164 095 negro</p>	<p>Ø a = 7,5 Ø b = 19 c = 21</p>  <p>163 201 negro</p>	<p>Ø a = 7,5 Ø b = 19,8 c = 15</p>  <p>163 945 negro</p>	<p>Ø a = 7,5 Ø b = 20 c = 12</p>  <p>162 706 negro</p>	<p>Ø a = 7,5 Ø b = 20,3 c = 18</p>  <p>162 614 negro</p>	<p>Ø a = 7,5 Ø b = 20 c = 23,5</p>  <p>162 211 negro</p>	<p>Ø a = 7,5 Ø b = 20 c = 23,5</p>  <p>162 212 gris</p>
---	---	---	---	---	--	---	--

<p>Ø a = 7,5 Ø b = 21,5 c = 15</p>  <p>163 886 negro</p>	<p>Ø a = 7,5 Ø b = 24 c = 31</p>  <p>162 646 negro</p>	<p>Ø a = 7,5 Ø b = - c = 27</p>  <p>163 969 negro</p>	<p>Ø a = 8 Ø b = 10 c = 15</p>  <p>162 440 blanco</p>	<p>Ø a = 8 Ø b = 14 c = 25</p>  <p>164 072 negro</p>	<p>Ø a = 8 Ø b = 16 c = 17</p>  <p>162 321 blanco</p>	<p>Ø a = 8 Ø b = 16 c = 17</p>  <p>162 602 negro</p>	<p>Ø a = 8 Ø b = 16 c = 17</p>  <p>163 009 negro</p>
--	--	---	---	---	---	--	--

<p>Ø a = 8 Ø b = 16 c = 19</p>  <p>162 934 negro</p>	<p>Ø a = 8 Ø b = 18 c = 16,5</p>  <p>162 382 gris oscuro</p>	<p>Ø a = 8 Ø b = 18 c = 16,5</p>  <p>162 383 negro</p>	<p>Ø a = 8 Ø b = 18 c = 16,5</p>  <p>162 910 gris claro</p>	<p>Ø a = 8 Ø b = 18 c = 25</p>  <p>162 579 gris oscuro</p>	<p>Ø a = 8 Ø b = 18 c = 25</p>  <p>162 580 negro</p>	<p>Ø a = 8 Ø b = 18 c = 26</p>  <p>162 753 gris oscuro</p>
--	--	--	---	---	--	--

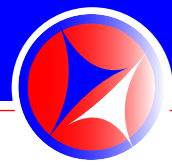



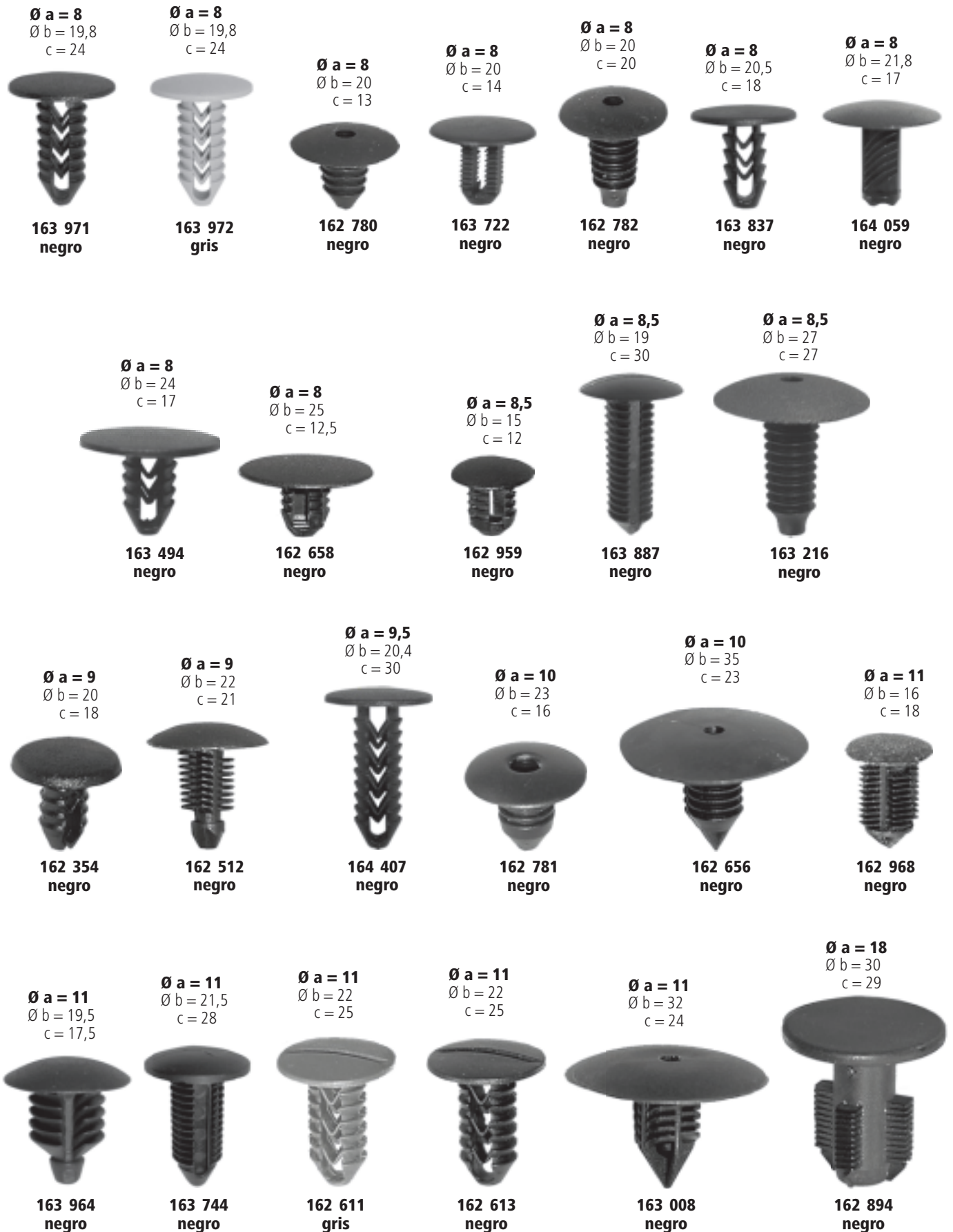

Familia 0300

BOTONES FIJACION





Familia 0300

Omegas	REF.	Ø interior	U.E.
	162 332	Ø 8	25
	162 570	Ø 11	25
	162 344	Ø 13	25
	162 575	Ø 16	25
	162 940	Ø 24	25



ABRAZADERAS

Familia 0300

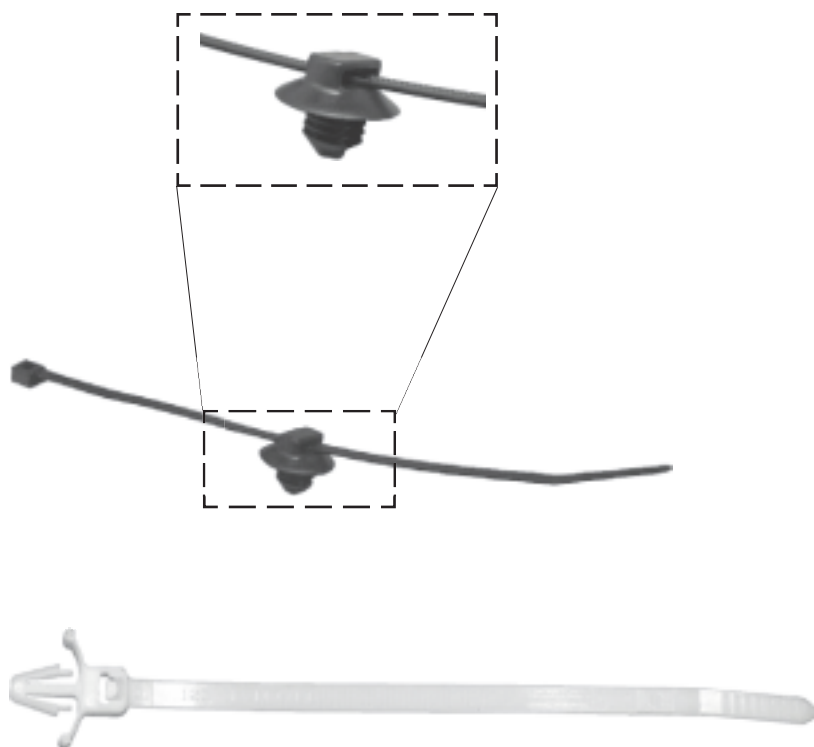

301 021

Abrazadera 3,6 x 140 con soporte

301 022

Abrazadera 3,6 x 200 con soporte

301 290

Abrazadera 4,8 x 115 con soporte



TUBOS EMPALMES

Familia 0300

2 vías, Ø 3 x 3



190 501

2 vías, Ø 3 x 5



190 502

2 vías, Ø 4 x 5



190 503

2 vías, Ø 5 x 5



190 504



190 517

2 vías, Ø 5 x 5

2 vías, Ø 5 x 5 «corto»
con válvula



190 505

2 vías, Ø 5 x 5 «largo»
con válvula



190 506



190 512

2 vías, Ø 3 x 5
con válvula



190 507

2 vías, Ø 5 x 5
con válvula



190 515

2 vías, Ø 5 x 5
con válvula



190 516

3 vías, Ø 4 x 4 x 5



190 508

3 vías, Ø 5 x 5 x 5



190 520

3 vías, Ø 5 x 5 x 5



190 518

3 vías, Ø 5 x 5 x 5

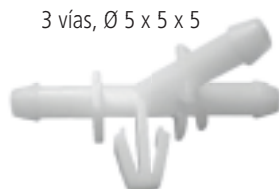

190 519

3 vías, Ø 5 x 5 x 5



190 510

3 vías, Ø 5 x 5 x 5
con válvula



190 513

3 vías, Ø 6 x 6 x 6
con válvula



190 509

3 vías, Ø 5 x 5 x 5
con válvula



190 514

3 vías, Ø 6 x 6 x 6
con válvula



190 511

3 vías, Ø 5 x 5 x 5
con válvula



Familia 0300

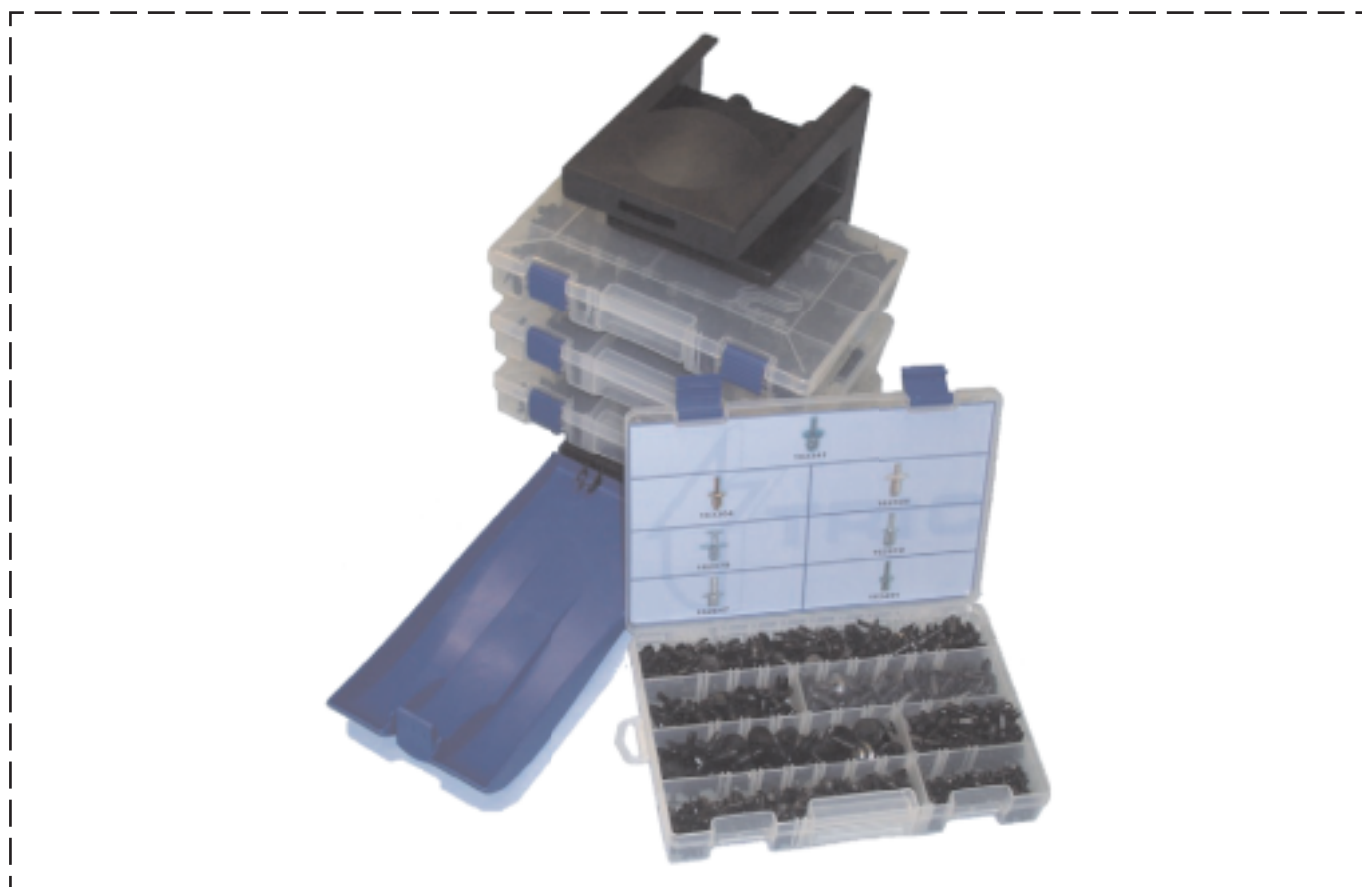

DESCRIPCION	REF.
Expositor vacío (4 bandejas a distribuir por el cliente)	180 501
Expositor «surtido fijaciones plásticas», compuesto de:	180 512

Bandeja 1	Bandeja 2	Bandeja 3	Bandeja 4
Botones fijación 1	Botones fijación 2	Tacos plástico	Remaches Plástico
100 x 162643 (Ø 6,5)	50 x 162512 (Ø 9)	100 x 162326 (6)	100 x 162431 (Ø 3,5)
50 x 162660 (Ø 7)	25 x 162656 (Ø 10)	50 x 162331 (7)	100 x 162647 (Ø 5)
100 x 162221 (Ø 7)	50 x 162613 (Ø 11)	25 x 162775 (7)	100 x 162819 (Ø 6)
100 x 162211 (Ø 7,5)	25 x 163008 (Ø 11)	100 x 162238 (7)	50 x 162979 (Ø 6,5)
100 x 162580 (Ø 8)		50 x 162715 (7)	50 x 162505 (Ø 7)
		50 x 162774 (7x7,5)	50 x 162373 (Ø 8)
		50 x 163211 (8)	100 x 162341 (Ø 8,5)
		100 x 162649 (8,5)	
		25 x 162480 (9,5)	
		50 x 162811 (10)	



Bandeja N° 1

Contenido	Unidades
Ref. 0300 162 580 (Ø 8)	100
Ref. 0300 162 211 (Ø 7,5)	100
Ref. 0300 162 221 (Ø 7)	100
Ref. 0300 162 660 (Ø 7)	150
Ref. 0300 162 643 (Ø 6,5)	100



Bandeja N° 2

Contenido	Unidades
Ref. 0300 163 008 (Ø 11)	25
Ref. 0300 162 613 (Ø 11)	50
Ref. 0300 162 656 (Ø 10)	25
Ref. 0300 162 512 (Ø 9)	50



Bandeja N° 3

Contenido	Unidades
Ref. 0300 162 811 (Ø 10)	50
Ref. 0300 162 480 (Ø 9,5)	25
Ref. 0300 162 649 (Ø 8,5)	100
Ref. 0300 163 211 (Ø 8)	150
Ref. 0300 162 774 (Ø 7,5)	50
Ref. 0300 162 715 (Ø 7)	50
Ref. 0300 162 238 (Ø 7)	100
Ref. 0300 162 775 (Ø 7)	25
Ref. 0300 162 331 (Ø 7)	50
Ref. 0300 162 326 (Ø 6)	100



Bandeja N° 4

Contenido	Unidades
Ref. 0300 162 341 (Ø 8,5)	100
Ref. 0300 162 373 (Ø 8)	50
Ref. 0300 162 505 (Ø 7)	150
Ref. 0300 162 979 (Ø 6,5)	50
Ref. 0300 162 819 (Ø 6)	100
Ref. 0300 162 647 (Ø 5)	100
Ref. 0300 162 431 (Ø 3,5)	100





B.M.W

Tornillos - Clips Metálicos / Screws - Metalic Clips



Familia 0300

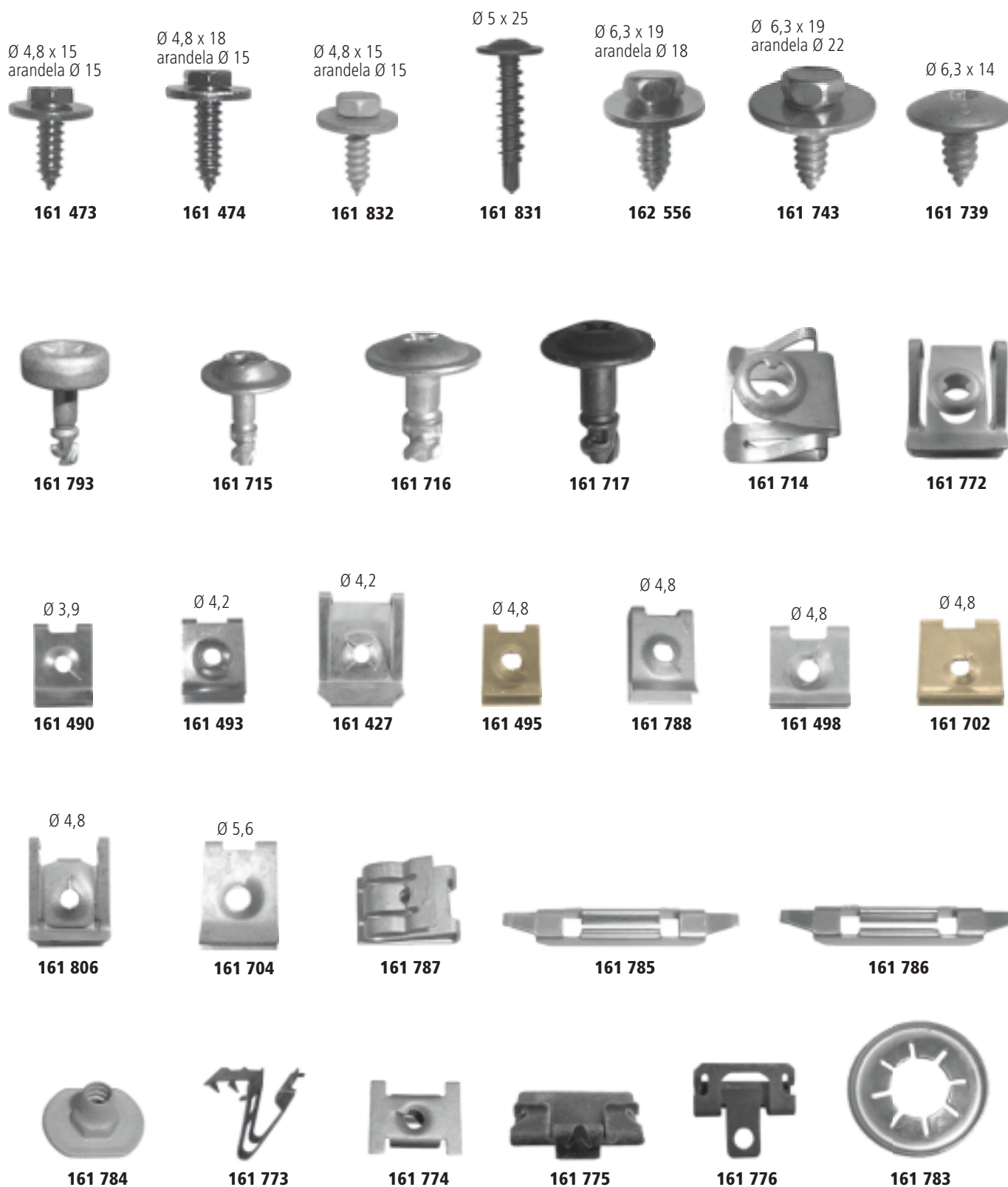



B.M.W

Moldura Techo - Parabrisas / Roof - Windscreen Clips

Familia 0300



163 711



164 357



163 775



163 776



163 777



163 809

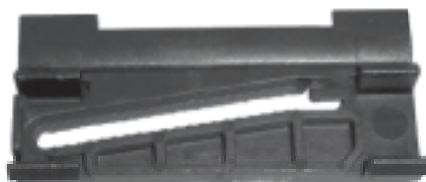

163 816



163 865



163 949



163 817



164 035

Ø 6,5
cabeza Ø 20



163 827

Ø 7



163 125

Ø 7



163 128

Ø 8
cabeza Ø 20



163 069



B.M.W

Moldura Parabrisas / Windscreen Clips

Familia 0300

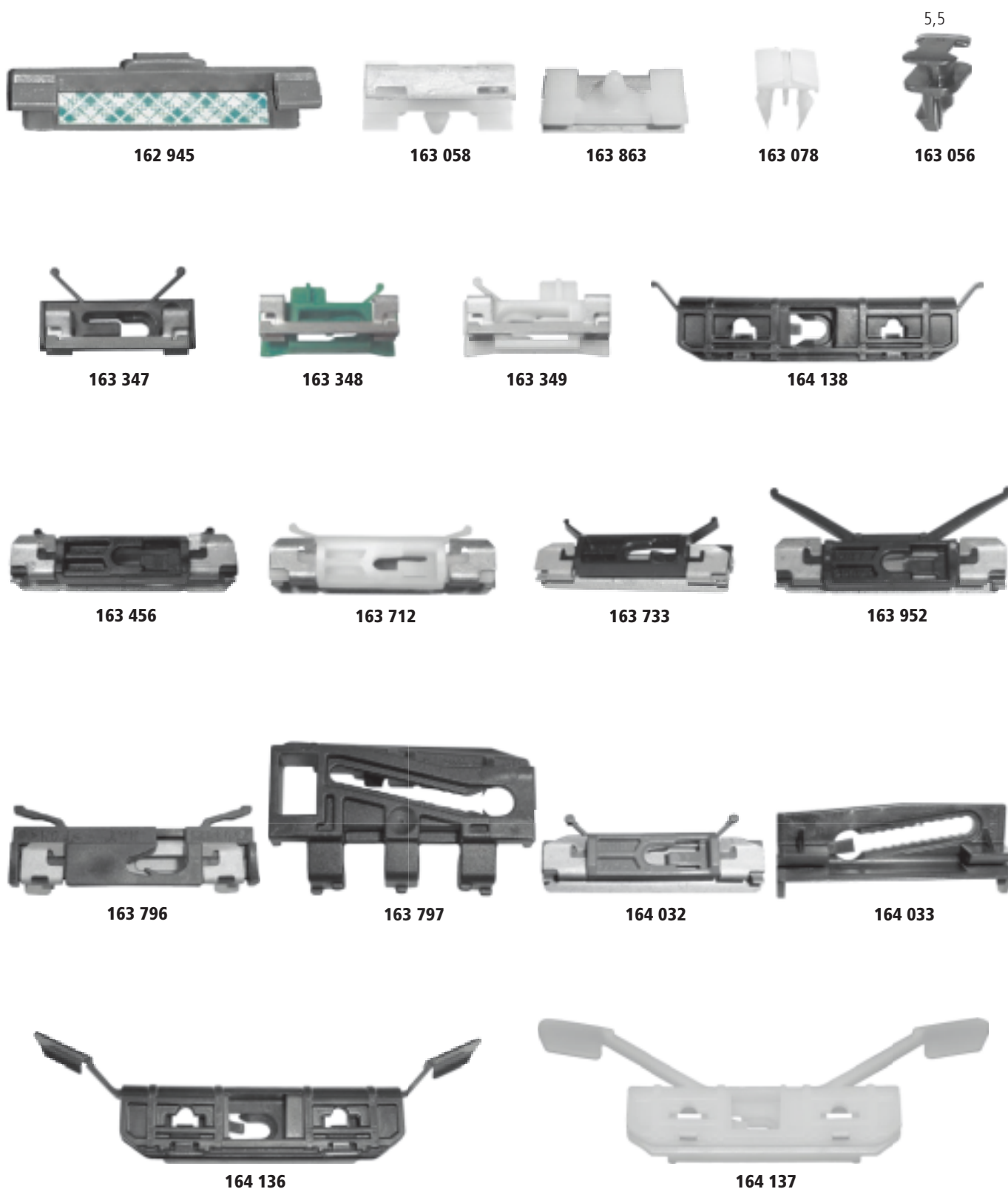
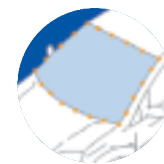



B.M.W

Cristal Elevation / Glass Window



Familia 0300

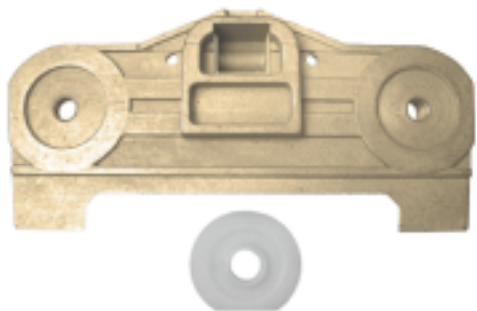

163 558*
Dcho. / Izdo.



163 055

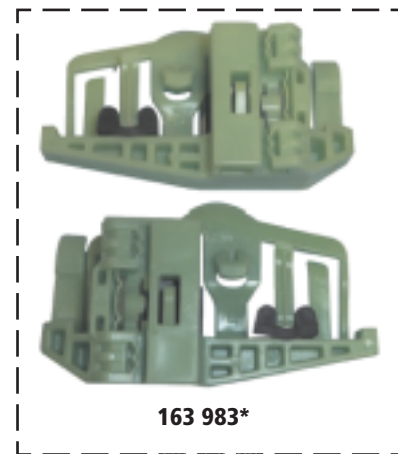

163 983*

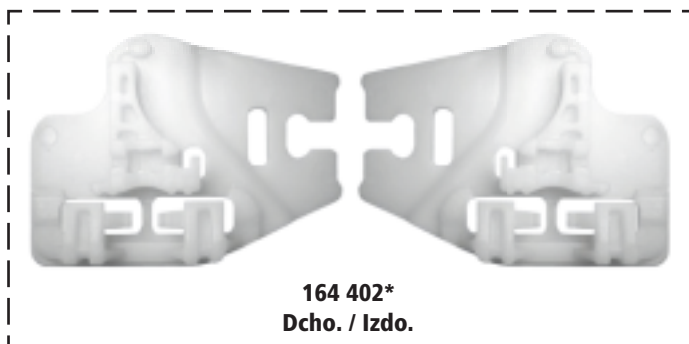

164 402*
Dcho. / Izdo.

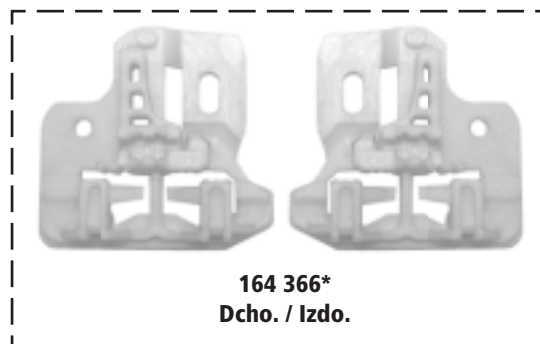

164 366*
Dcho. / Izdo.



163 556* - Dcho
163 557* - Izdo



163 984* - Dcho
163 985* - Izdo



163 986* - Dcho
163 987* - Izdo

* (imagen 1/2 tamaño real)

Juntas Puerta / Door Seals

Familia 0300



163 950



163 951



163 749



163 801



B.M.W

Levas Cerradura Puerta / Door Locking

Familia 0300



163 062



181 596* - Dcho
181 597* - Izdo

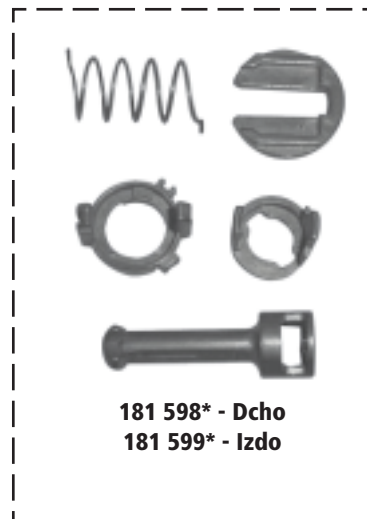

181 598* - Dcho
181 599* - Izdo

Varios Usos / Other Applications

Familia 0300

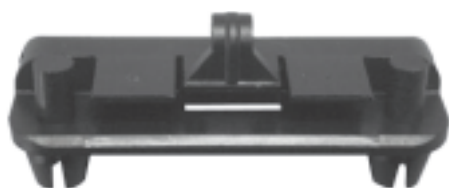

163 153



162 918



163 460



164 026

Moldura puerta / Bodyside clips

Familia 0300



163 820



163 928



163 840



163 822



163 841



163 828



B.M.W

Moldura puerta / Bodyside clips

Familia 0300





B.M.W

Panel Puerta - Tapizados Interiores Door Panel - Interior Trim



Familia 0300



162 235



163 059



163 060



163 465



163 773



163 751



163 747



163 750



163 752



164 038



164 039



163 843



163 753



164 042



163 849



163 818



161 420



164 057



164 295



163 061



163 829



163 823



Ø 8

162 782



Ø 8

164 072



163 746



163 077



B.M.W

Tacos Plástico / Plastic Plugs



Familia 0300



Remaches Plástico / Plastic Rivets



Familia 0300





B.M.W

Remaches Plástico / Plastic Rivets



Familia 0300

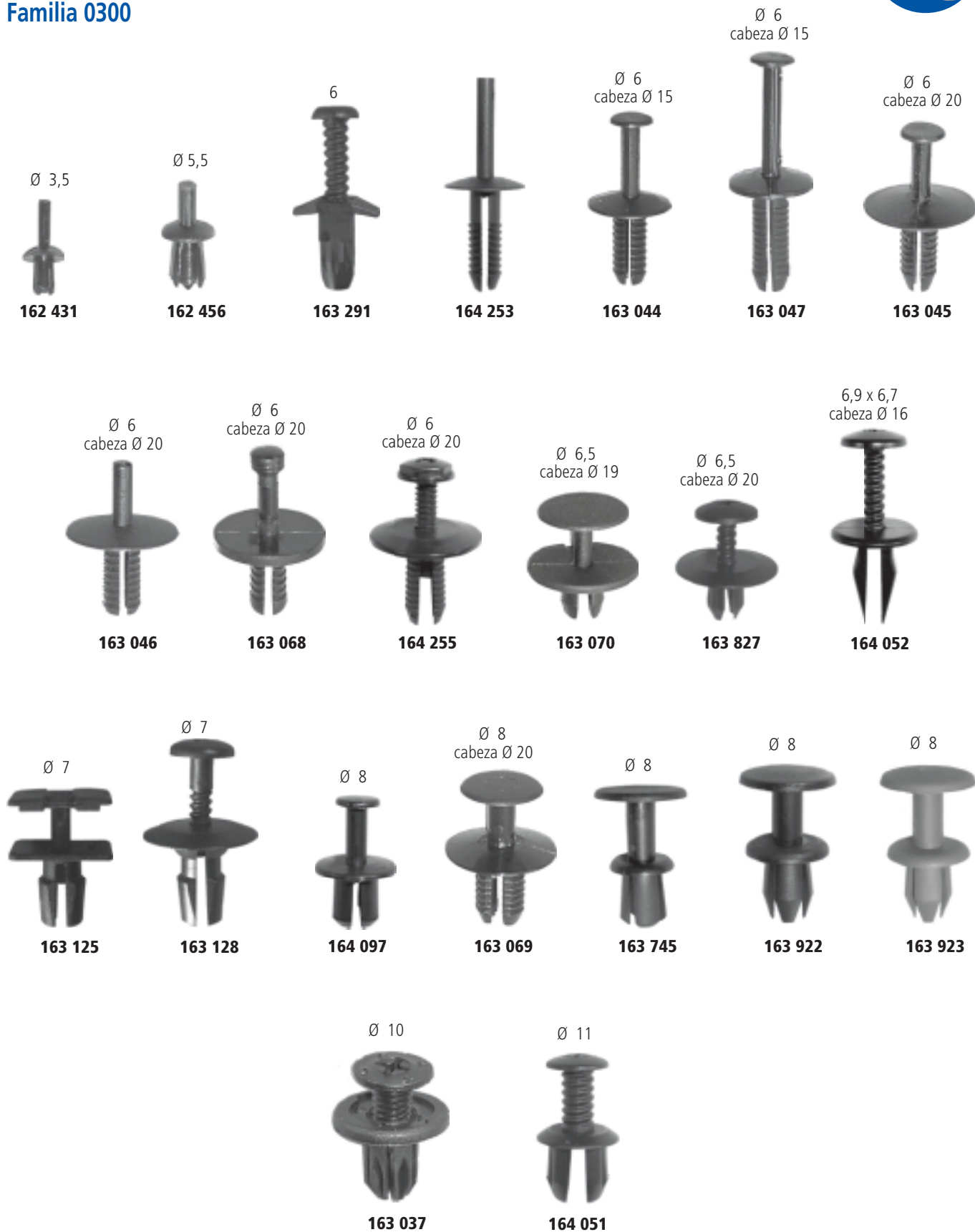



CHEVROLET / DAEWOO

Familia 0300



190 365*

* (imagen 1/2 tamaño real)



163 876



163 899



163 898

6,7 x 7,4
Tornillo Ø 4,2



164 134



163 293



163 012



164 046



164 047



164 043



163 307



163 037



163 163



163 814



CHRYSLER / DODGE / JEEP

Familia 0300



164 249



164 251



164 250



164 377



164 404



164 432



164 375



164 376



164 415



164 406



163 091



164 405

DAHIATSU

Familia 0300



163 263



163 264



163 265



DACIA

Familia 0300

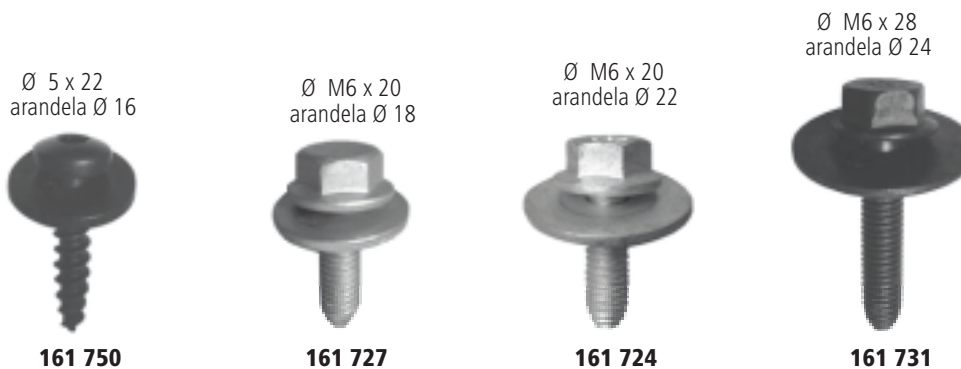

163 666* - Dcho
163 667* - Izdo



190 064



190 080



190 388*

* (imagen 1/2 tamaño real)



DACIA

Familia 0300



163 082



163 727



163 491



164 391



163 881



163 222



163 883



164 361



164 301



163 006



163 490



163 489



163 008



163 140



163 088



162 941



163 906



162 485

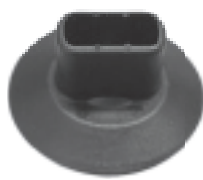

163 320



164 303



FIAT (ALFA ROMEO / FIAT / LANCIA)

Tornillos / Screws

Familia 0300



Ø 3,9 x 25



161 454

Ø 4,5 x 19
arandela Ø 12



161 760

Ø 4,8 x 22



162 710

Ø 4,8 x 20



161 453

Ø M5 x 11



161 758

Ø M6 x 17



162 528

Ø M6 x 16
arandela Ø 15



161 475

Ø M6 x 18



161 752

Ø M6 x 18



162 529

Ø M6 x 20



161 706

Ø M6 x 20



161 456

Ø M6 x 20



161 457

20 x 20
Tornillo Ø M6 x 22



162 356

Ø M6 x 22



162 526

Ø M6 x 25
arandela Ø 18



161 723

Ø M6 x (10+21)



161 458

Ø M8 x 10,5
arandela Ø 17



161 754

20 x 20
Tornillo Ø M8 x 18



162 357

Ø M8 x 20



161 455

Ø M8 x 16



162 363

Ø M8 x 20



161 476

Ø M8 x 20



161 705



FIAT (ALFA ROMEO / FIAT / LANCIA)

Clips Metálicos / Metallic Clips

Familia 0300



Ø 4,2



161 488

Ø 4,8



161 411

Ø M4



161 701

Ø M5



162 444

Ø M6



161 464

Ø M6



162 442

Ø 6



162 439

Ø 6



162 525

Ø 6



162 527

Ø 6



162 697

20 x 20
Tornillo Ø 8



162 359

Ø exterior 10
tornillo Ø 4



161 759

Tornillo Ø 4,2



161 459



161 797



161 485



161 448



161 751

Ø 2,4 x 5



162 362



FIAT (ALFA ROMEO / FIAT / LANCIA)

Rejilla o Capó / Front Grille or Hood



Familia 0300



162 273



162 515



162 516



162 898



162 270



162 899



163 220



163 095



163 096



163 097



162 351



164 435



163 495



161 408



162 406



162 524

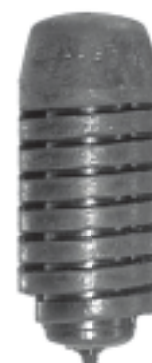

164 381



FIAT (ALFA ROMEO / FIAT / LANCIA)

Moldura Parabrisas / Windscreen Clips

Familia 0300

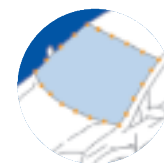

163 608



163 248



163 852



Ø 7,5

164 294



Ø 8

163 837



163 140



164 153



Ø 8

163 344



162 965

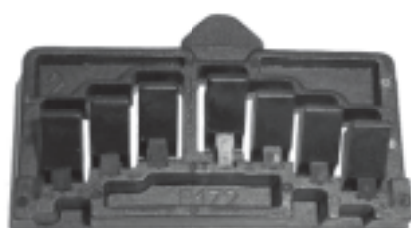

163 920



163 425



FIAT (ALFA ROMEO / FIAT / LANCIA)

Bombas y Surtidor Lavaparabrisas / Washer Pumps or Jets



Familia 0300



190 001



190 003



190 004



190 040



190 039



190 046



190 047



190 050



FIAT (ALFA ROMEO / FIAT / LANCIA)

Bombas y Surtidor Lavaparabrisas / Washer Pumps or Jets



Familia 0300



190 351*



190 358*



190 360*



190 383*



190 385*



190 364*

* (imagen 1/2 tamaño real)



190 048



190 049



190 051



190 029



190 054



190 038



FIAT (ALFA ROMEO / FIAT / LANCIA)

Parachoque / Bumper

Familia 0300

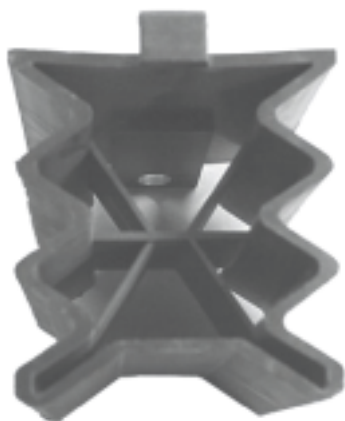

162 514*



162 404*



Ø 18

162 894



162 893



162 536*

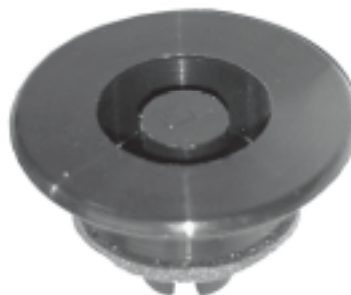

162 403



162 400

* (imagen 1/2 tamaño real)



FIAT (ALFA ROMEO / FIAT / LANCIA)

Parachoque / Bumper

Familia 0300

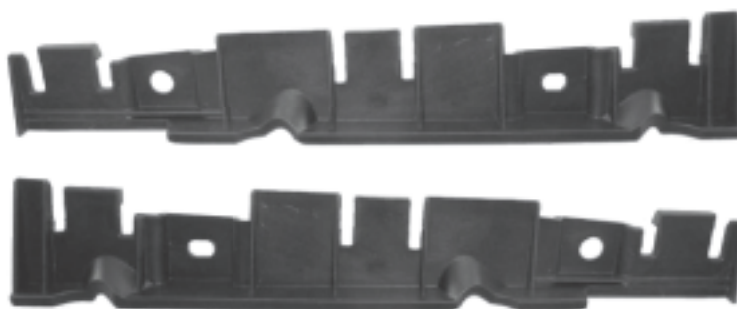

163 946 *- Dcho
163 947 *- Izdo



164 340 *- Dcho
164 341 *- Izdo



164 342 *- Dcho
164 343 *- Izdo

* (imagen 1/2 tamaño real)



FIAT (ALFA ROMEO / FIAT / LANCIA)

Faro / Headlight

Familia 0300



171 434



173 080



162 253



162 250



162 251



162 247



162 248



162 533



162 535



162 720



164 434



FIAT (ALFA ROMEO / FIAT / LANCIA)

Faro / Headlight

Familia 0300

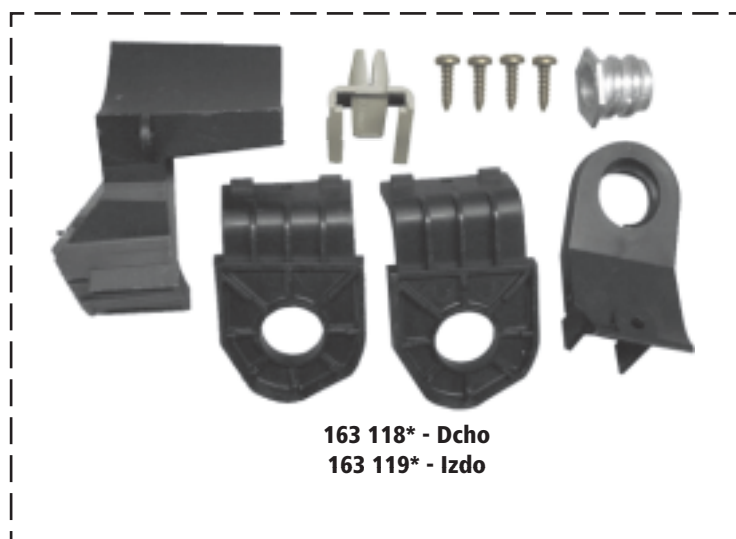

163 118* - Dcho
163 119* - Izdo



163 606* - Dcho
163 607* - Izdo

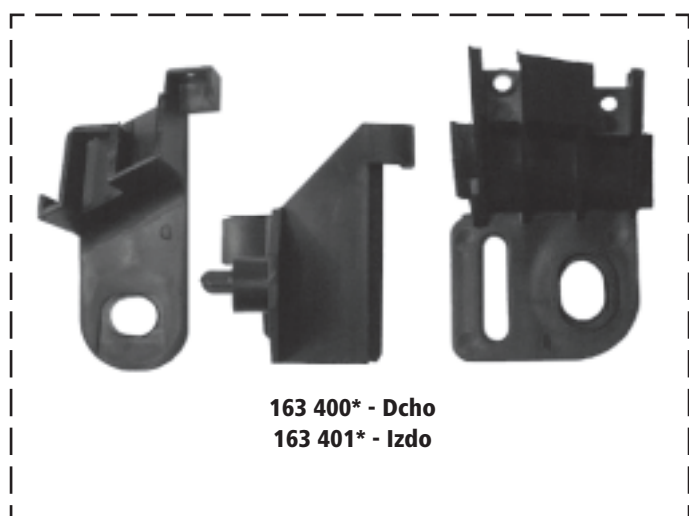

163 400* - Dcho
163 401* - Izdo



163 402* - Dcho
163 403* - Izdo

* (imagen 1/2 tamaño real)

Varilla Cerradura Puerta / Door Locking

Familia 0300



162 427



162 870



162 872



162 873

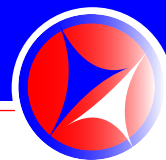

FIAT (ALFA ROMEO / FIAT / LANCIA)

Cristal Elevalunas / Glass Window

Familia 0300



163 025



162 305

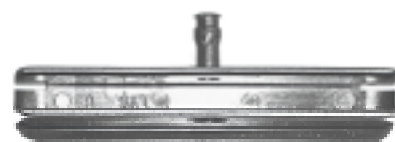

163 053



162 900



162 901



162 316



163 609



162 886



163 492



162 897



FIAT (ALFA ROMEO / FIAT / LANCIA)

Cristal Elevalunas / Glass Window

Familia 0300



164 012 *- Dcho
164 013 *- Izdo



164 010 *- Dcho
164 011 *- Izdo

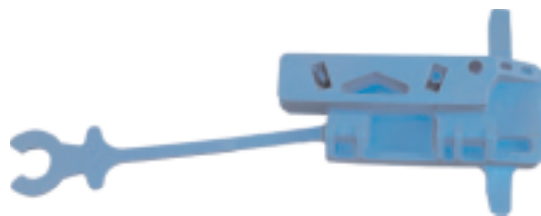

164 008 *- Dcho
164 009 *- Izdo



163 552 *- Dcho
163 553 *- Izdo



164 362 *- Dcho
164 363 *- Izdo



163 500*

* (imagen 1/2 tamaño real)



FIAT (ALFA ROMEO / FIAT / LANCIA)

Moldura puerta / Bodyside clips



Familia 0300



162 992



162 993



163 098



164 370



163 052



163 612



162 691



162 679



162 680



162 964



164 285



162 263



162 907



162 475



162 391



162 392



162 944



163 394

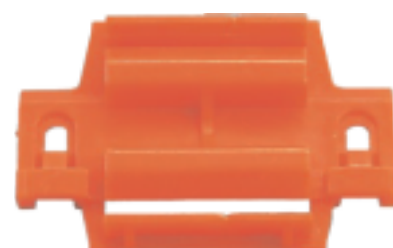

163 011



FIAT (ALFA ROMEO / FIAT / LANCIA)

Botones Fijación / Buttons



Familia 0300





FIAT (ALFA ROMEO / FIAT / LANCIA)

Panel Puerta - Tapizados Interiores
Door Panel - Interior Trim

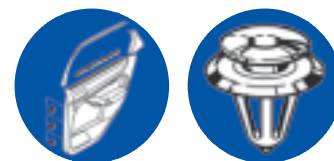

Familia 0300



162 229



162 598



162 227



163 093



164 404



162 699



Ø 6

162 465



162 714



162 232



163 094



7 x 10

162 895



8 x 8

163 499



FIAT (ALFA ROMEO / FIAT / LANCIA)

Panel Puerta - Tapizados Interiores
Door Panel - Interior Trim



Familia 0300



162 510



162 399



162 398



162 976



163 397



162 530



163 965



163 968



163 221



163 399



163 083



163 453



162 378



163 608



163 967



162 379



162 228



163 013



FIAT (ALFA ROMEO / FIAT / LANCIA)

Tacos Plástico / Plastic Plugs

Familia 0300



6 x 6
Tornillo Ø 3



162 326

6 x 7
Tornillo Ø 3,5



162 245

7 x 7
Tornillo Ø 3,5



162 240

8 x 8
Tornillo Ø 4,5



162 534

7 x 7
Tornillo Ø 3



162 238

7 x 7
Tornillo Ø 4,2



162 244

7 x 7
Tornillo Ø 4,2



163 611

7 x 7
Tornillo Ø 4,8



163 498

8 x 8,5
Tornillo Ø 4,2



164 079

8 x 8
Tornillo Ø 4,8

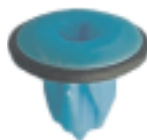

162 966

8 x 8
Tornillo Ø 4,8



162 887

8 x 8
Tornillo Ø 4,8



163 218

Ø 8,5
Tornillo Ø 3,5



162 264

10 x 10
Tornillo Ø 4,2



162 545

13 x 18
Tornillo Ø 6,3



162 393



FIAT (ALFA ROMEO / FIAT / LANCIA)

Tacos Plástico / Plastic Plugs



Familia 0300

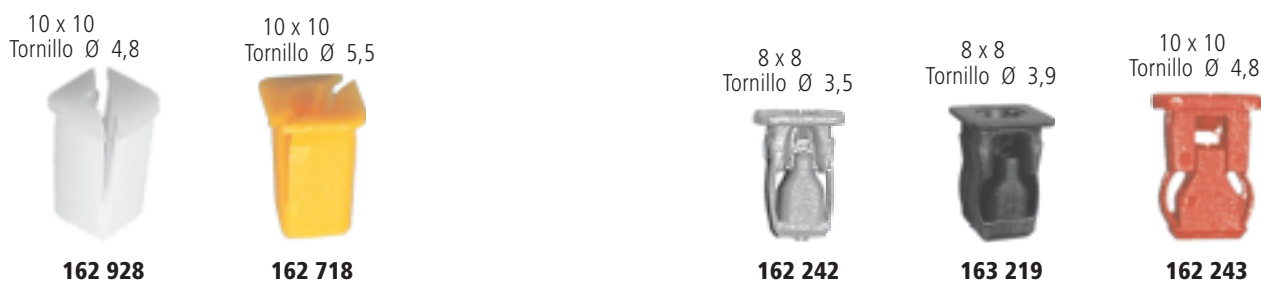

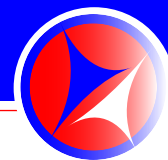

FIAT (ALFA ROMEO / FIAT / LANCIA)

Tacos Plástico / Plastic Plugs



Familia 0300

7 x 12
Tornillo Ø 4,2



162 902

7 x 14
Tornillo Ø 3,9



162 892

7 x 13
Tornillo Ø 4,2



162 523

7 x 14
Tornillo Ø 3,9



163 222

7 x 15
Tornillo Ø 4,2



162 888

Tornillo Ø 5



163 830

Tornillo Ø 5



163 970

Tornillo Ø 6



163 493

10 x 10
Tornillo Ø 3,9



162 891

Varios Usos / Other Applications



Familia 0300



162 390



162 911



162 880



164 437



FIAT (ALFA ROMEO / FIAT / LANCIA)

Remaches Plástico / Plastic Rivets



Familia 0300

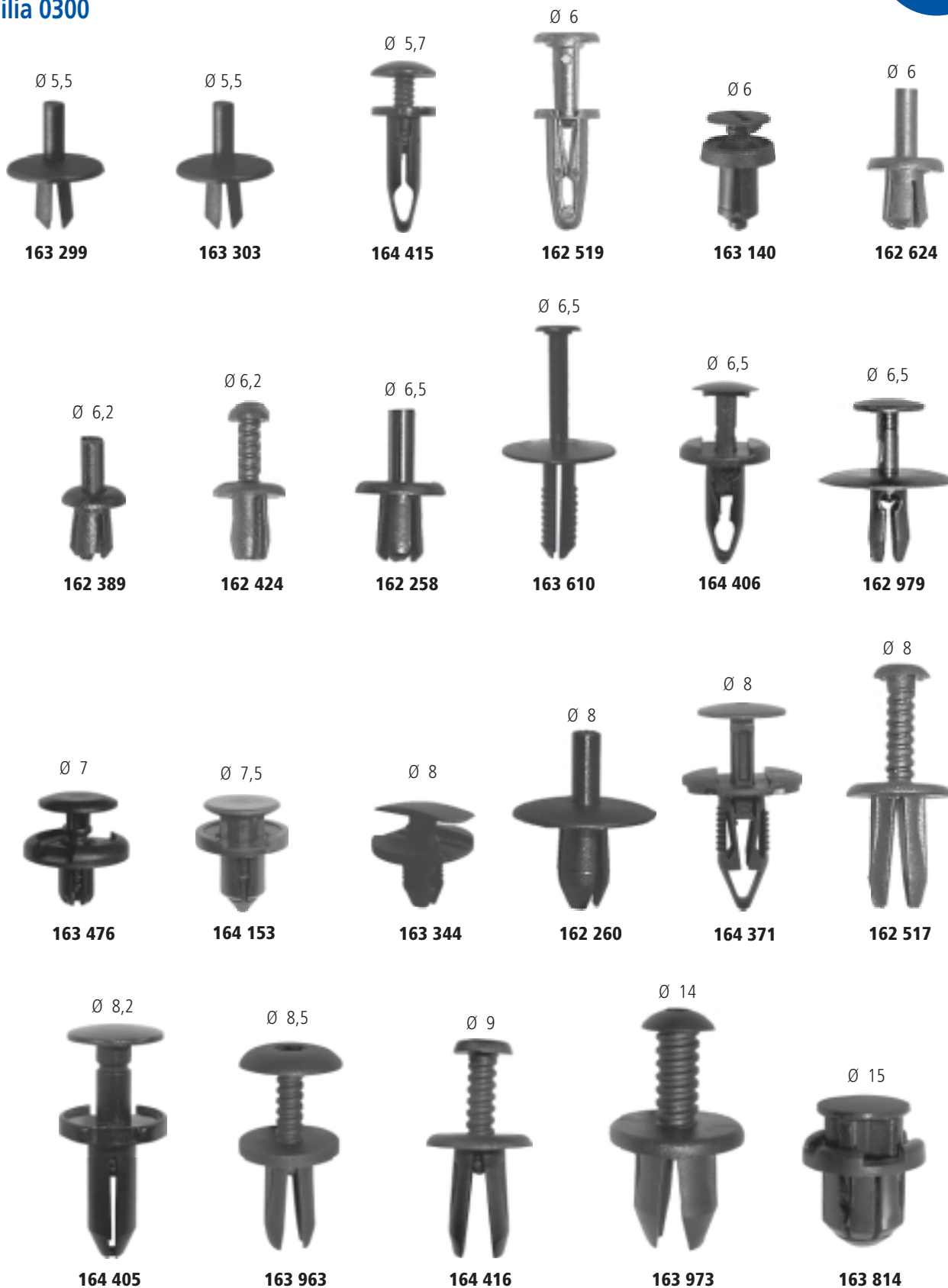



FORD

Tornillos - Clips Metálicos / Screws - Metalic Clips



Familia 0300

Ø 4,8 x 15
arandela Ø 15



161 473

Ø 4,8 x 18
arandela Ø 15



161 474

Ø 5,5 x 19
arandela Ø 18



162 555

Ø 5,5 x 19
arandela Ø 22



161 742

Ø 6,3 x 19
arandela Ø 18



162 556

Ø 6,3 x 19
arandela Ø 22



161 743



161 809



161 810



161 479



161 811



161 822



161 823



161 824



164 685



161 462



161 461



161 790



161 785

Ø 2,4 x 5



162 362



FORD

Tornillos - Clips Metálicos Screws - Metallic Clips

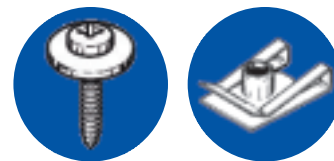

Familia 0300

Ø 3,5



161 409

Ø 3,9



161 490

Ø 4,2



161 492

Ø 4,2

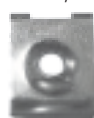

161 493

Ø 4,8



161 800

Ø 4,8



161 801

Ø 5,6



161 704

Ø 6,3



161 465

Ø 6,3

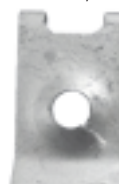

161 771

Ø 6,3

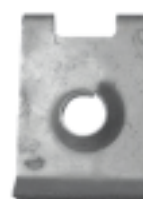

161 747

Ø 4



161 414

Ø M 5



161 703

Ø M6



161 438

Ø M8



161 499

Ø M6 «oval»



161 740

Ø M 6



162 465

Ø M6



162 375

Ø M6



162 711

Ø M8



162 712



FORD

Bombas y Surtidor Lavaparabrisas / Washer Pumps or Jets



Familia 0300



190 365*



190 366*



190 367*



190 368*



190 359*

* (imagen 1/2 tamaño real)



190 007



190 008



190 069



190 070



190 071



FORD

Moldura Parabrisas / Windscreen Clips

Familia 0300

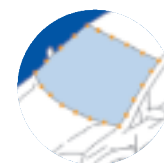

163 021



163 022



163 018



163 915



162 812



163 023



161 811



163 613



164 264

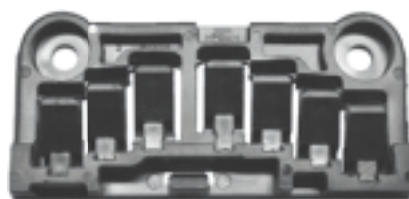

163 133

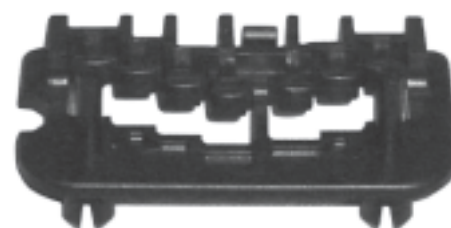

163 641



FORD

Faro / Headlight

Familia 0300



163 766



163 508*
Dcho. / Izdo.



162 282



163 180



162 298 - Dcho
162 299 - Izdo



162 409



163 505



190 382*



173 080*

* (imagen 1/2 tamaño real)



FORD

Cristal Elevation / Glass Window

Familia 0300



164 073



163 566 *- Dcho
163 567 *- Izdo

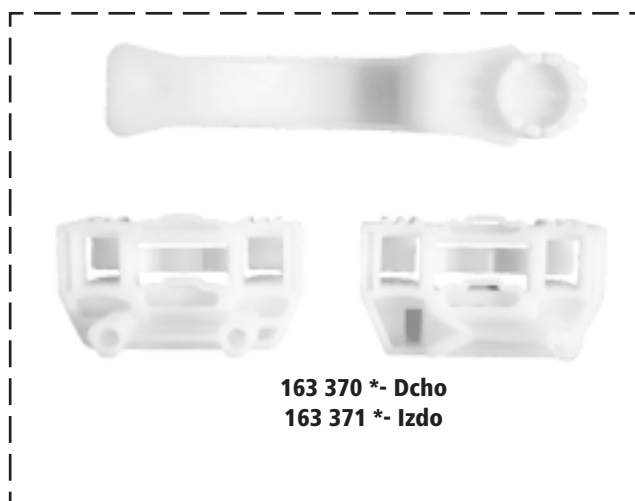

163 370 *- Dcho
163 371 *- Izdo



163 570 *- Dcho
163 571 *- Izdo

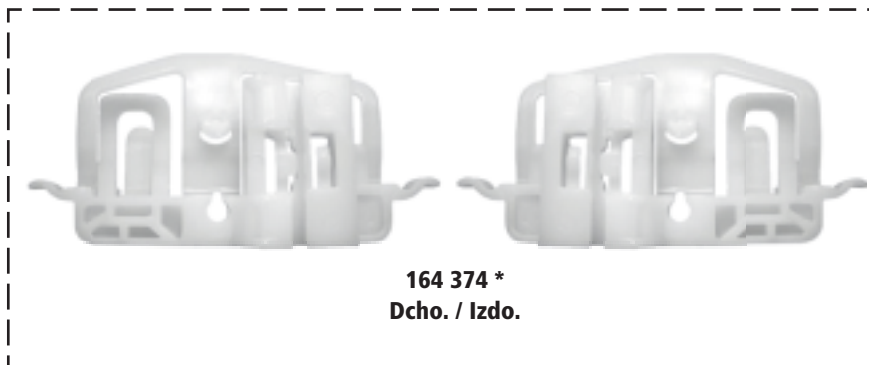

164 374 *
Dcho. / Izdo.

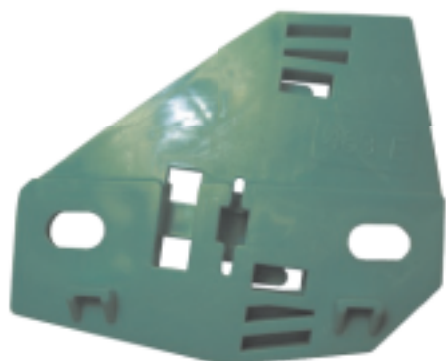

163 568 *- Dcho
163 569 *- Izdo



163 564 *- Dcho
163 565 *- Izdo



163 988 *- Dcho
163 989 *- Izdo

* (imagen 1/2 tamaño real)



FORD

Juntas Puerta / Door Seals

Familia 0300



162 261



162 262



163 135



163 684



163 231

Parachoque / Bumper

Familia 0300

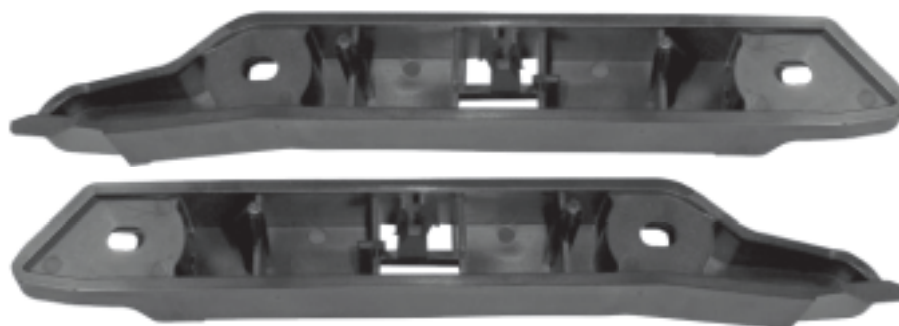

164 332 *- Dcho

164 333 *- Izdo



164 334 *- Dcho

164 335 *- Izdo

* (imagen 1/2 tamaño real)



FORD

Moldura puerta / Bodyside clips

Familia 0300



164 044



164 045



164 068

Rejilla o Capó / Front Grille or Hood

Familia 0300



162 257



162 651



162 952



163 016



163 765



163 233



162 918



163 440



FORD

Panel Puerta - Tapizados Interiores Door Panel - Interior Trim



Familia 0300



162 423



161 420



162 548



162 230



162 953



162 950



163 685



163 754



163 741



163 960



162 385



163 230



163 683



162 844



163 686



162 951



164 263



FORD

Panel Puerta - Tapizados Interiores Door Panel - Interior Trim

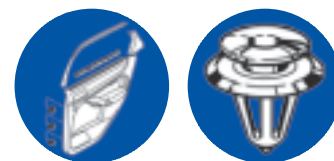

Familia 0300



162 372



163 594



164 094



164 076



163 441



162 810



163 013



163 090



162 847



163 681



163 682



162 405



164 262



162 235



162 231



162 973



164 260



163 900



163 721



FORD

Varios Usos / Other Applications

Familia 0300



162 971



162 972



163 914



181 404*



164 026



162 266



162 618

* (imagen NO a tamaño real)

Tacos Plástico / Plastic Plugs

Familia 0300



tornillo Ø 4,2



162 956

tornillo Ø 3,9



162 949

tornillo Ø 5



163 830



164 403

tornillo Ø 6



162 948



FORD

Tacos Plástico / Plastic Plugs

Familia 0300



6,7 x 6,7
Tornillo Ø 3,9



162 963

6,7 x 12,9
Tornillo Ø 2,9



162 851

7 x 11,7
Tornillo Ø 4,2



163 767



162 238

7 x 7
Tornillo Ø 4,2



162 715

8,6 X 7,7
Tornillo Ø 4,2

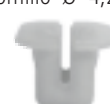

164 061

7,5 x 10
Tornillo Ø 5,5



163 351

7,5 x 11,4
Tornillo Ø 2,9



163 298

7,5 x 8,5
tornillo Ø 5



163 921

tornillo Ø 5



163 368

8 x 10
tornillo Ø 5,5



162 955

8,2 x 8,2
Tornillo Ø 4,2



163 439

9,5 x 9,5
Tornillo Ø 4,8



162 480

9,5 x 9,5
Tornillo Ø 6,35



163 367

9,5 x 14
Tornillo Ø 4,8



163 180

10 x 10
Tornillo Ø 4,8



162 928

10 x 10
Tornillo Ø 5,5



162 718

10 x 13
Tornillo Ø 5,5



162 811

10 x 14
Tornillo Ø 6



163 443

7,5 x 10,5
Tornillo Ø 2,9



164 062



FORD

Botones Fijación / Buttons

Familia 0300

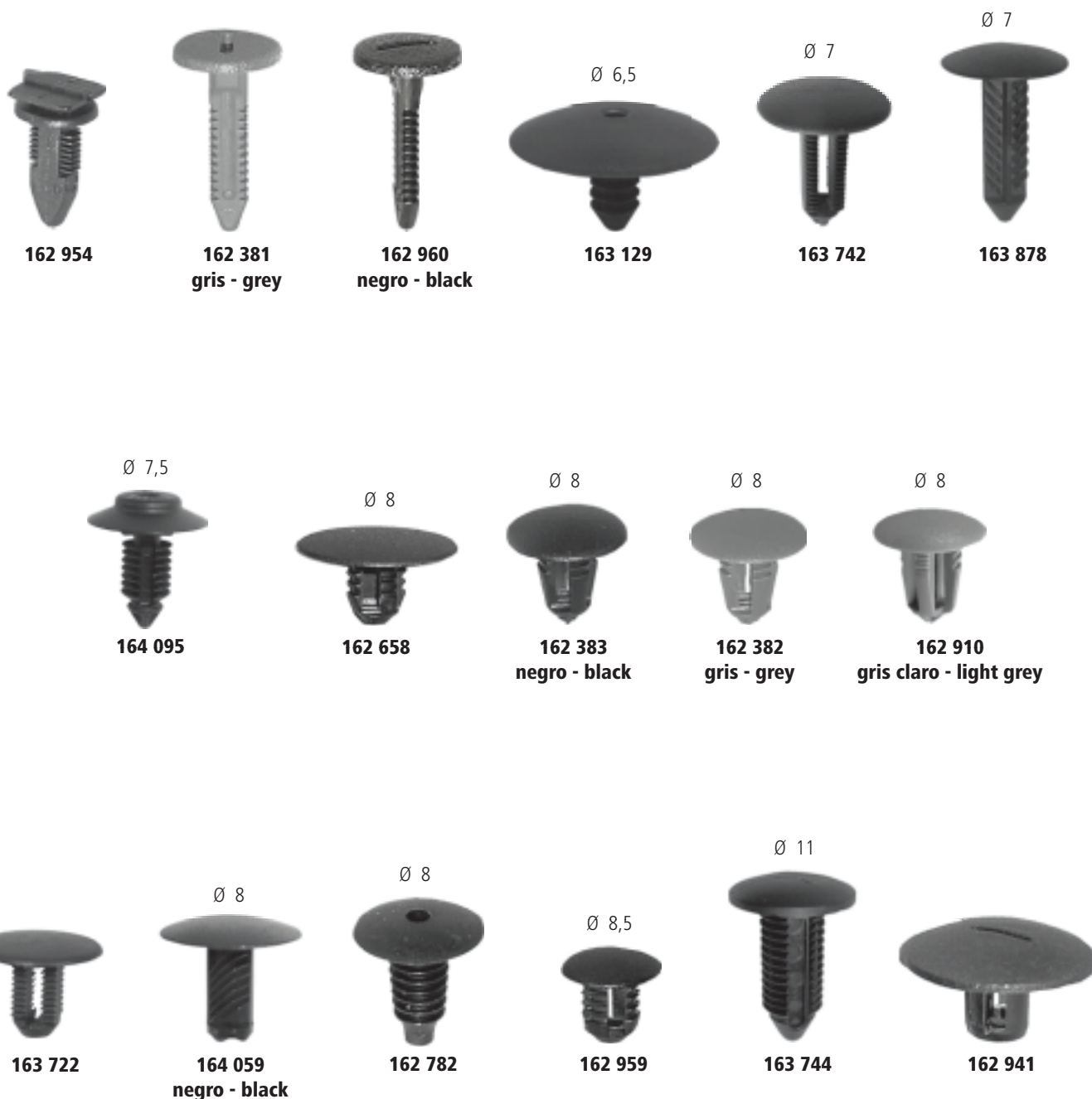



FORD

Remaches Plástico / Plastic Rivets

Familia 0300

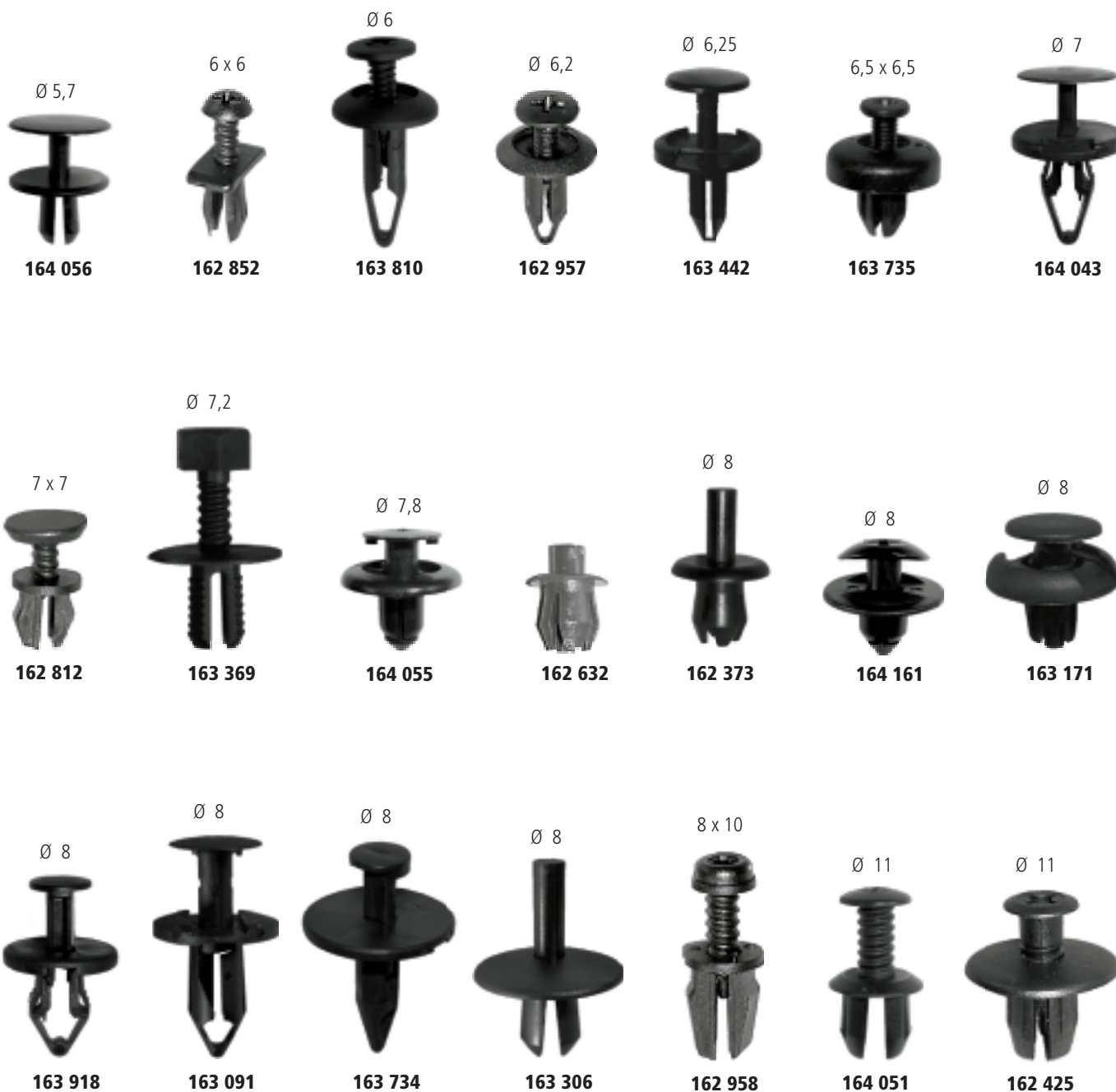



HONDA

Familia 0300



190 365*



190 363*

* (imagen 1/2 tamaño real)



164 175



164 176



164 181



164 182



163 804



164 208



164 214



164 215



164 216



164 217



163 515



163 516



163 517



163 518



163 805



HONDA

Familia 0300



163 124



162 947



164 207



164 224



164 223



164 211



164 212



164 213



164 210



163 957



164 190



164 191



163 131



163 132



163 123



HONDA

Familia 0300



164 225



163 159



163 191



163 294



163 812



164 206



164 394



164 205



163 896



163 618



164 226



163 173



163 174



164 219



163 172



163 281



163 192



163 519



163 520



HONDA

Familia 0300



163 168



163 169



163 476



164 155



163 813



163 482



163 277



163 170



163 171
91501-S04-003



163 035



163 036



164 154



164 177



164 178



163 164



163 037



163 802



163 163



HYUNDAI / KIA

Familia 0300



190 365*



190 363*

* (imagen 1/2 tamaño real)



163 548* - Dcho
163 549* - Izdo



164 428



163 976



163 700



163 704



164 360



163 701



163 702



163 703



163 503



164 179



Ø 10

164 315



HYUNDAI / KIA

Familia 0300



163 688



163 690



163 691



7 x 7
Tornillo Ø 3,9

163 281



8,5 x 8,5
Tornillo Ø 4,2

163 689



163 962



164 359



164 358



163 266



163 694



163 692



163 693



163 698



163 695



163 696



163 697



163 699



163 892



LEXUS

Familia 0300



163 706



163 359



163 650



164 418



163 251



163 250



163 621



163 161



163 162



164 020



163 259



163 193



163 258



163 356



164 188



163 160



163 165



164 091



LEXUS

Familia 0300



163 526



163 527



163 528



163 982



164 189



164 099



163 249



164 087



163 167



163 476



163 530



163 529



164 299



163 166



163 981



163 296



163 297



163 358



164 292



MAZDA

Familia 0300



190 363*

* (imagen 1/2 tamaño real)



163 159



163 507



163 521



163 522



164 414



163 803



163 472



164 183



164 289



163 531



163 473



164 234



164 235



MAZDA

Familia 0300



164 287



164 286



164 353



164 236



163 369



164 156



164 055



163 503



163 474



164 086



164 157



164 315



163 172



163 275



163 520



163 619

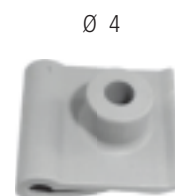

164 233



MERCEDES

Tornillos - Clips Metálicos / Screws - Metalic Clips

Familia 0300



Ø 4,8 x 15
arandela Ø 15



161 473

Ø 4,8 x 18
arandela Ø 15



161 474

Ø 5,5 x 19
arandela Ø 22



161 742

Ø 6,3 x 19
arandela Ø 18



162 556

Ø 6,3 x 19
arandela Ø 22



161 743

Ø 2,9



161 487

Ø 2,9



161 757

Ø 4



161 414

Ø 4,2



161 492

Ø 4,2



161 493

Ø 4,8



161 498

Ø 4,8



161 702

Ø 4,8



161 748

Ø 4,8



161 749

Ø M5



161 703

Ø M5

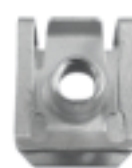

161 813

Ø 5,5



161 746

Ø 6,3



161 747

Ø M8



161 812



161 825



161 826



MERCEDES

Bombas y Surtidor Lavaparabrisas / Washer Pumps or Jets



Familia 0300



190 352*



190 353*



190 371*



190 355*



190 378*



190 370*

* (imagen 1/2 tamaño real)

Cristal Elevelunas / Glass Window



Familia 0300



163 550 - Dcho
163 551 - Izdo



163 659
Dcho. / Izdo.



MERCEDES

Varios Usos / Other Applications

Familia 0300



163 057



164 125



163 907



163 405



163 406



164 081



164 108



164 112



164 128

Moldura Techo - Parabrisas Roof - Windscreen Clips

Familia 0300



163 462



163 463



164 279



163 784



164 280



164 281



163 943



162 919



163 537



163 640



163 464



MERCEDES

Moldura Techo - Parabrisas Roof - Windscreen Clips

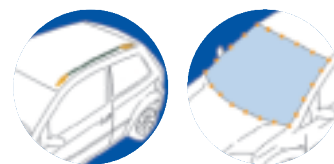

Familia 0300

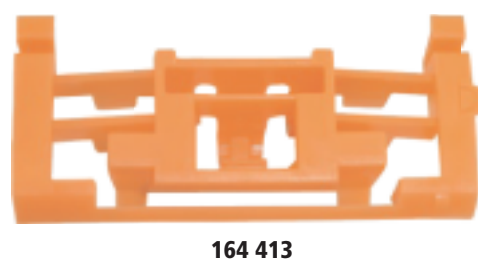
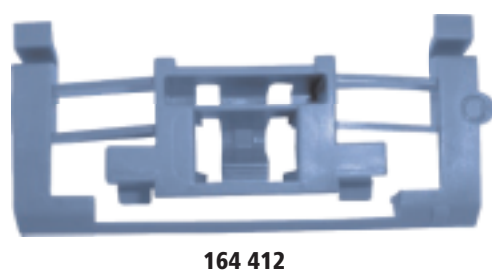
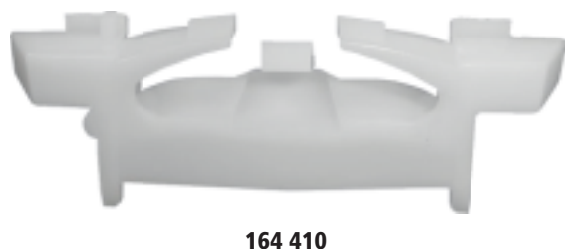
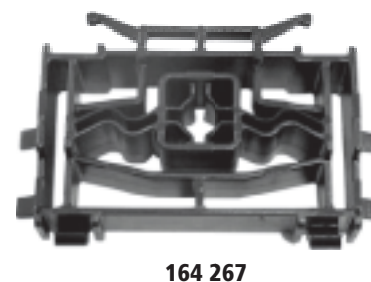



MERCEDES

Moldura puerta / Bodyside clips

Familia 0300



163 103



163 101



163 102



162 735



162 736



162 737



162 739



162 744



162 745



162 747



162 740



162 741



162 751



162 749



162 734



162 752



162 733



162 748



163 412



163 286



163 853



163 854



163 413



163 414



163 415



MERCEDES

Moldura puerta / Bodyside clips

Familia 0300



163 411



163 100



164 114



164 115



164 149



164 150



164 151



164 152



163 416



163 285



163 420



163 421



163 422



163 423



163 778



163 781



163 785



163 782



164 111



164 116



164 117



MERCEDES

Moldura puerta / Bodyside clips

Familia 0300



162 738



163 417



163 419



163 768



163 418



162 746



163 857



162 913



163 284

Tacos Plástico / Plastic Plugs

Familia 0300



Tornillo Ø 4



162 924

Tornillo Ø 5



163 288

tornillo Ø 5



163 830

Tornillo Ø 5



163 287

Tornillo Ø 5



164 119

7 x 7
Tornillo Ø 3



162 238

7 x 7,5
Tornillo Ø 3,5



164 120

6 x 15
Tornillo Ø 3,5



163 063

8 x 8
Tornillo Ø 4



164 124

8 x 8
Tornillo Ø 5,5



163 283

8 x 8
Tornillo Ø 5,5



163 410



MERCEDES

Panel Puerta - Tapizados Interiores Door Panel - Interior Trim



Familia 0300



162 554



163 407



163 773



163 789



163 790



163 791



164 127



162 953



163 649



163 282



163 861



164 027



163 831



163 795



163 788



163 833



163 786



163 787



163 408



163 771

Botones Fijación / Buttons

Familia 0300



164 113



163 424



162 453



164 109



162 753



162 934



162 780



MERCEDES

Remaches Plástico / Plastic Rivets

Familia 0300



163 856

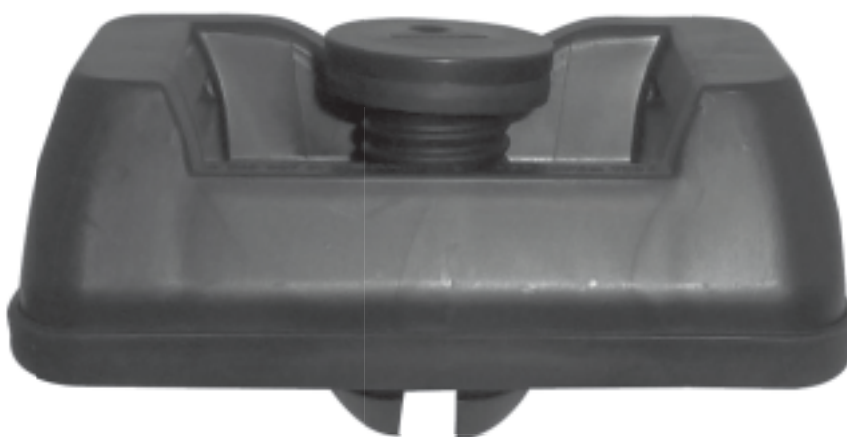

163 855



163 779

Ø 3,5



162 431

Ø 5



163 926

Ø 5



164 110

Ø 5



162 259

Ø 5



163 792

Ø 5



164 275

Ø 5,5



162 456

Ø 5,5



163 305

Ø 5,5



163 793



MERCEDES

Remaches Plástico / Plastic Rivets

Familia 0300

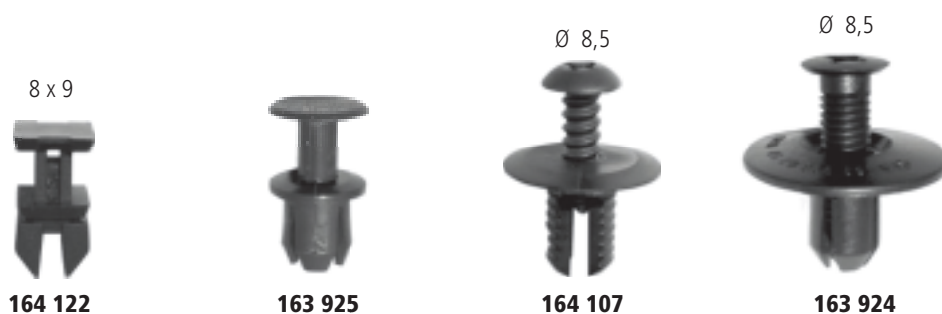
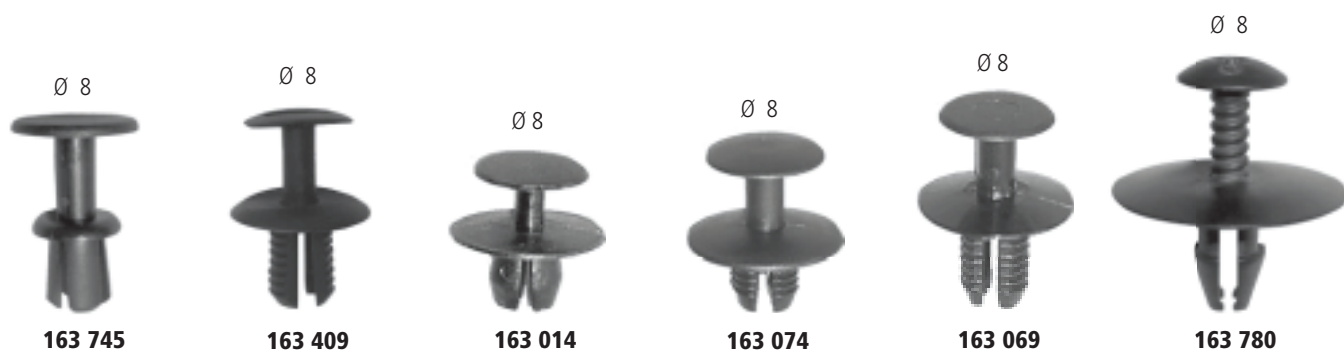
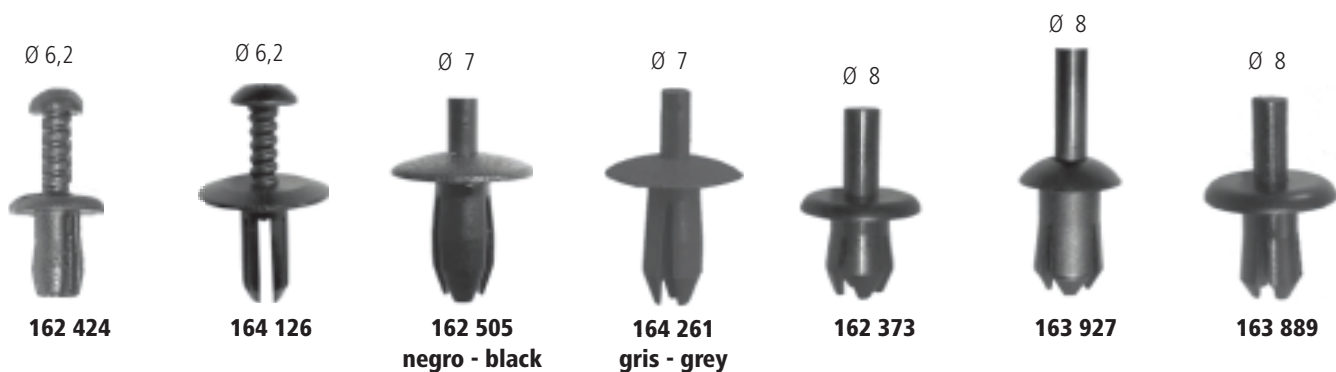



MINI

Tornillos - Clips Metálicos / Screws - Metalic Clips

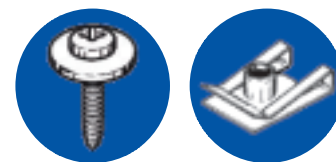

Familia 0300

Ø 4,8 x 15
arandela Ø 15



161 832



161 715



161 772



161 794



Ø 4,8

161 806



161 774



161 783



161 785

Bombas y Surtidor Lavaparabrisas / Washer Pumps or Jet



Familia 0300



190 378*

* (imagen 1/2 tamaño real)



190 067



190 066



190 068



190 065



MINI

Moldura Techo - Parabrisas Roof - Windscreen Clips



Familia 0300



163 651



163 652



163 653



163 636



163 836



163 750



164 036



164 039



163 758



163 759



164 139



164 140



MINI

Pasoruada - Molduras Exteriores Wheel Arch - Bodyside Clips

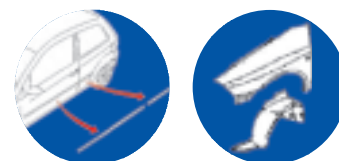

Familia 0300



Tacos Plástico / Plastic Plugs



Familia 0300





MINI

Tapizados Interiores - Otros Usos
Interior Trim - Other Applications

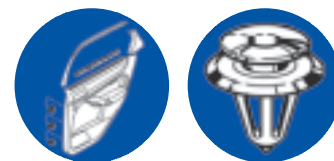

Familia 0300



163 750



163 752



164 038



163 843



163 754



163 753



164 034



164 036



163 727



161 420



164 295



163 849

Remaches Plástico / Plastic Rivets

Familia 0300



Ø 6
cabeza Ø 15



163 044

Ø 6
cabeza Ø 20



163 045



164 255



Ø 6,5
cabeza Ø 20

163 827

Ø 8
cabeza Ø 20



163 069

Ø 10



163 037

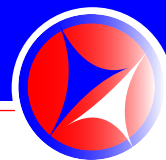

MITSUBISHI

Familia 0300



190 365*



190 363*

* (imagen 1/2 tamaño real)



163 649



164 310



164 173



164 174



163 643



164 240



164 201



164 202



164 203



163 977



163 832



163 273



164 309



164 408



164 409



MITSUBISHI

Familia 0300



164 395



163 161



164 199



164 237



164 222



163 272



164 197



164 198



164 200



164 306



164 439

10 x 10
Tornillo Ø 4,8



163 538

10 x 10
Tornillo Ø 5,5



163 274

8,1 x 8,5
Tornillo Ø 6



164 352

8,5 x 8,5
Tornillo Ø 5,5



163 268



163 539

Ø 8



164 238

Ø 6



164 239



163 267



164 307



164 308



163 270

Ø 6



163 271

Ø 6,5



163 300

Ø 7



163 269

Ø 8



163 482

Ø 8



163 171

Ø 8
cabeza Ø 20



163 069

Ø 8,5



164 085

Ø 10



164 315



NISSAN

Familia 0300

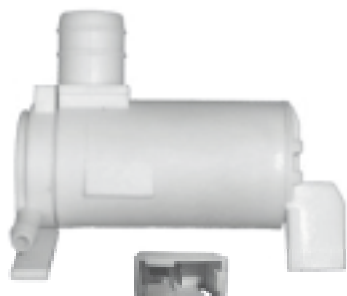

190 384*



190 388*

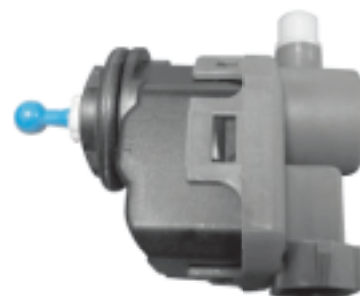

176 213*

* (imagen 1/2 tamaño real)



163 156



163 904



164 232



164 229



164 231



163 158



163 279

7 x 7
Tornillo Ø 3,5



162 817

8,5 x 8,5
Tornillo Ø 4,8



163 520

8,5 x 8,5
Tornillo Ø 5,5



163 484

8,5 x 8,5
Tornillo Ø 5,5



163 268



163 120

8 x 11,6
Tornillo Ø 5,5



164 101



164 227



163 155



163 157



163 480



163 615



NISSAN

Familia 0300



163 280



163 481



163 385

Ø 6,2



162 934

Ø 8



162 910

Ø 8



163 594



163 806



163 807



164 300



163 483



164 284



164 282



164 429



164 425



164 424



163 329

Ø 5



164 228

Ø 6



164 084

Ø 6



163 815

Ø 8



163 277

Ø 8



164 314

Ø 8



164 230

Ø 8



163 482

Ø 8



163 166

Ø 8



163 448

Ø 8



163 278

Ø 8



163 088

Ø 8,2



164 254

Ø 8,2



163 276

Ø 10



163 802

Ø 10



OPEL

Tornillos - Clips Metálicos / Screws - Metalic Clips

Familia 0300

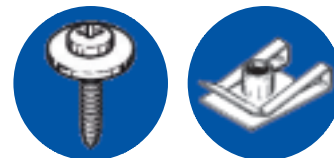

Ø 4,8 x 15
arandela Ø 15



161 473

Ø 4,8 x 18
arandela Ø 15



161 474

Ø 5 x 22
arandela Ø 16



161 750

Ø 5,5 x 19
arandela Ø 18



162 555

Ø 5,5 x 19
arandela Ø 22



161 742

Ø 6 x 20



161 721

Ø M6 x 20
arandela Ø 18



161 727

Ø 6,3 x 19
arandela Ø 18



162 556

Ø 6,3 x 19
arandela Ø 22



161 743

Ø 4,2



161 427

Ø 5,5



161 745

Ø 5,6



161 704

Ø 6,3



161 465

Ø 6,3

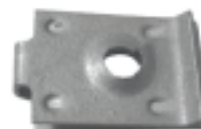

161 756

Ø M5

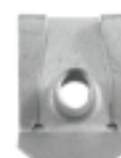

161 815

Ø 6



162 711

Ø 8



162 712

Ø 2,4 x 5



162 362



161 816



161 781



162 266



OPEL

Bombas y Surtidor Lavaparabrisas / Washer Pumps or Jets



Familia 0300



190 010



190 011



190 012



190 013



190 364*



190 368*



190 371*



190 372*



190 373*



190 389*

* (imagen 1/2 tamaño real)

Varios Usos / Other Applications

Familia 0300



181 417*



164 141



162 918

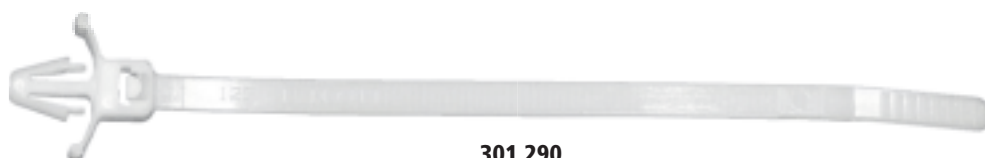

301 290

* (imagen NO a tamaño real)



OPEL

Rejilla o Capó / Front Grille or Hood

Familia 0300



162 874



163 057



164 132



164 133

Moldura Techo - Parabrisas Roof - Windscreen Clips

Familia 0300



163 425



163 930



163 901



163 800



164 272



164 273



OPEL

Moldura Techo - Parabrisas Roof - Windscreen Clips



Familia 0300



163 732



162 937

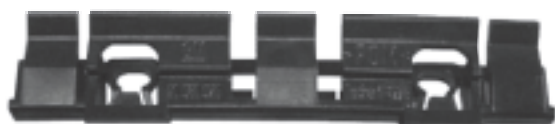

163 345



164 025



164 093



163 852



163 431



163 851

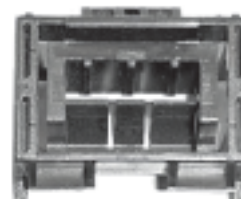

162 938



163 642



162 826



163 594



163 876



163 899



164 433



OPEL

Faro / Headlight

Familia 0300

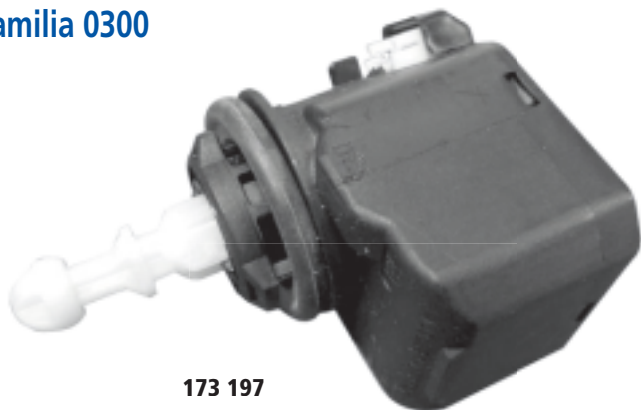

173 197



178 098



162 281



162 412



162 809



162 345

Cristal Elevelunas / Glass Window

Familia 0300

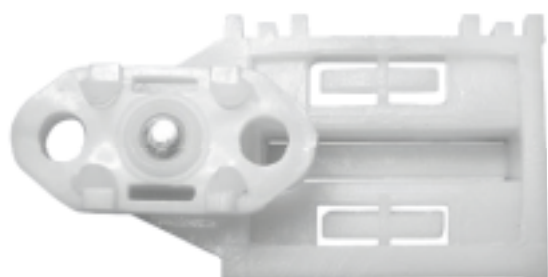

163 559
Dcho. / Izdo.



163 560
Dcho. / Izdo.



163 562 - Dcho
163 563 - Izdo

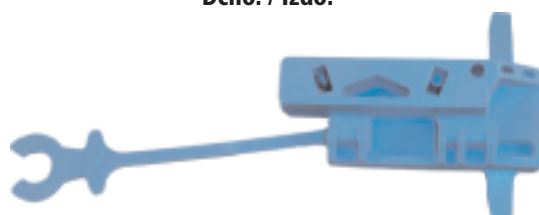

164 008 *- Dcho
164 009 *- Izdo



163 561
Dcho. / Izdo.



OPEL

Parachoque / Bumper

Familia 0300



164 336 *- Dcho
164 337 *- Izdo

* (imagen 1/2 tamaño real)

Botones Fijación / Buttons

Familia 0300

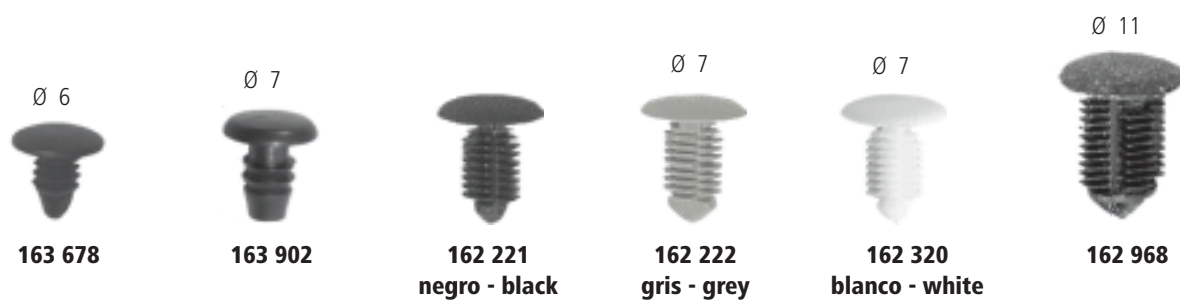
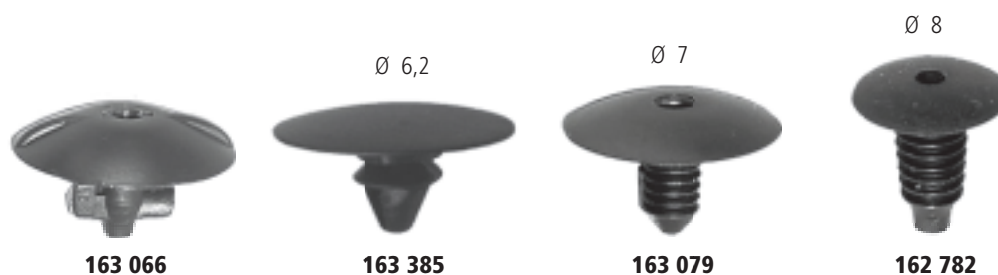
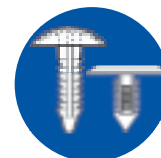



OPEL

Moldura puerta / Bodyside clips

Familia 0300



162 992



162 993



162 994



162 824



163 332



163 434



163 149



163 430



163 432



163 433



163 065



163 911



162 319



162 411



162 324



162 944



163 675*



163 676*



163 798



163 799

* (imagen 1/2 tamaño real)



164 135



OPEL

Panel Puerta - Tapizados Interiores Door Panel - Interior Trim



Familia 0300



162 630



162 410



163 614



163 679



163 680



164 046



164 047



164 121



162 853



163 141



162 826



163 012



163 064



163 876



163 899



OPEL

Juntas Puerta / Door Seals



Familia 0300

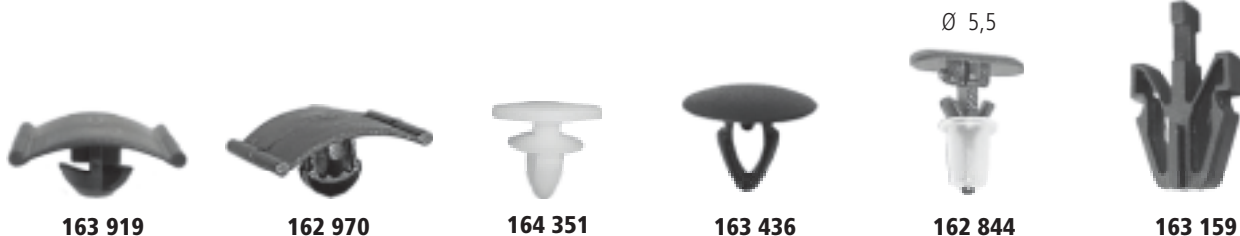

163 919

162 970

164 351

163 436

Ø 5,5

162 844

163 159

Tacos Plástico / Plastic Plugs



Familia 0300



163 897

163 898



tornillo Ø 5

163 677

tornillo Ø 5

163 437

tornillo Ø 5

163 150

tornillo Ø 5,5

162 974

tornillo Ø 5,5

163 916

tornillo Ø 6

162 948

7 x 14
Tornillo Ø 3,9



163 222

8 x 8
Tornillo Ø 4



162 903

6,7 x 7,4
Tornillo Ø 4,2



164 134

8,2 x 8,2
Tornillo Ø 4,2



163 439

8 x 10
Tornillo Ø 5,5



163 039



OPEL

Remaches Plástico / Plastic Rivets

Familia 0300

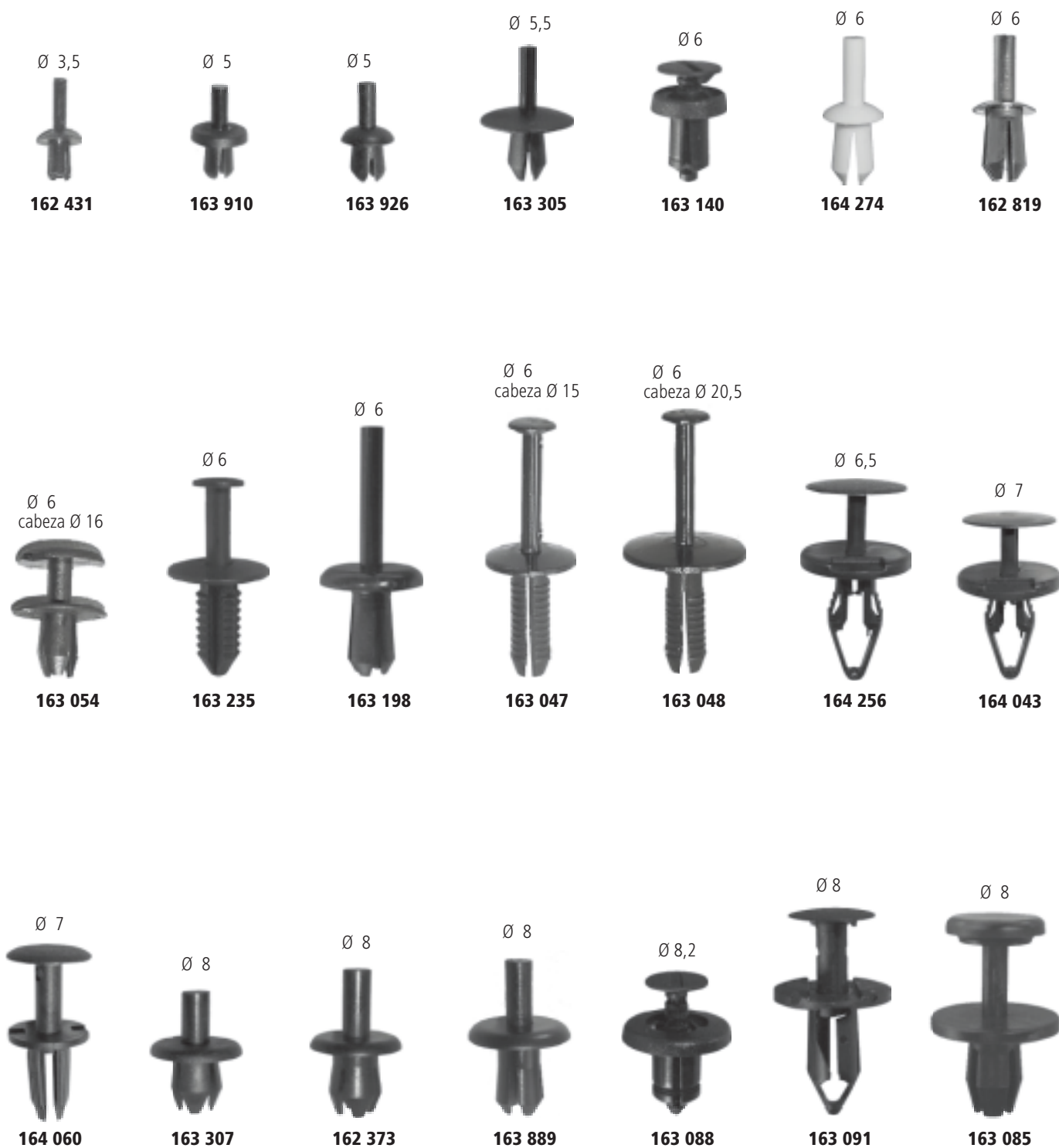



P.S.A. (PEUGEOT / CITROEN)

Tornillos / Screws

Familia 0300



Ø 4,5 x 20



161 803

Ø 4,5 x 25



161 804

Ø 4,5 x 30



161 805

Ø 4,5 x 19
arandela Ø 12



161 760

Ø 4,5 x 19
arandela Ø 16



161 761

Ø 4,8 x 15
arandela Ø 15



161 473

Ø 4,8 x 18
arandela Ø 15



161 474

Ø 6 x 20



161 721

Ø M6 x 18
arandela Ø 18



161 730

Ø M6 x 25
arandela Ø 18



161 723

Ø M6 x 19



161 486

Ø 6,3 x 20
arandela Ø 20



161 827

161 718



162 435



162 436



P.S.A. (PEUGEOT / CITROEN)

Clips Metálicos / Metallic Clips



Familia 0300

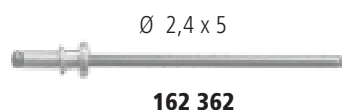
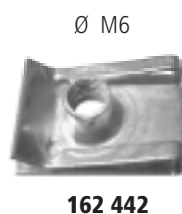



P.S.A. (PEUGEOT / CITROEN)

Bombas y Surtidor Lavaparabrisas / Washer Pumps or Jets



Familia 0300



190 072



190 041



190 074



190 075



190 025



190 026



190 035



190 034



190 044



190 073



190 042



190 043



190 045



190 057

3 vías, Ø 5 x 5 x 5



190 520



190 076



190 077



P.S.A. (PEUGEOT / CITROEN)

Bombas y Surtidor Lavaparabrisas / Washer Pumps or Jets

Familia 0300



190 357*



190 358*



190 360*



190 376*



190 388*



190 361*



190 383*



190 385*

* (imagen 1/2 tamaño real)



P.S.A. (PEUGEOT / CITROEN)

Varilla Cerradura Puerta / Door Locking



Familia 0300



162 547



162 813



162 858



162 859



163 084



163 318



162 983



162 485



163 322

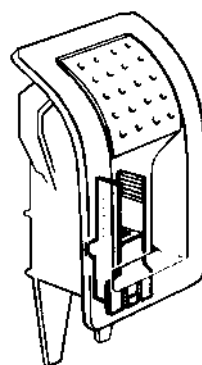

162 798



162 799

Moldura Parabrisas / Windscreen Clips

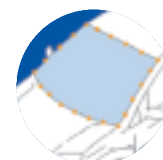

Familia 0300



163 920



163 867



163 645

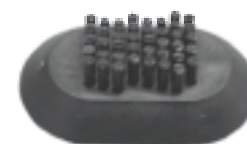

163 316



162 965



163 979



P.S.A. (PEUGEOT / CITROEN)

Moldura Parabrisas / Windscreen Clips

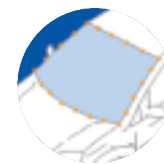

Familia 0300



163 312



164 392



163 672



163 313



163 705



163 314



163 713



163 315



162 633



162 978



163 594



163 082

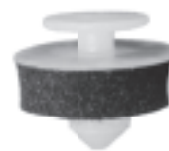

163 373



163 379



162 967

Ø 4



163 717

Ø 6,5



163 300



163 912

Ø 7,5



164 294



164 129

Ø 4,5



164 171



P.S.A. (PEUGEOT / CITROEN)

Rejilla o Capó / Front Grille or Hood



Familia 0300



163 032



163 200



164 633



163 913



162 879



163 880



163 495



164 090



163 096



163 729



163 885



163 888



162 814



163 323



163 869



163 728



163 723



164 385



164 381



164 387



164 388



164 389



164 390



P.S.A. (PEUGEOT / CITROEN)

Parachoque / Bumper

Familia 0300



164 158



164 252



164 344 *- Dcho
164 345 *- Izdo



164 347 - Izdo



164 346 - Dcho



P.S.A. (PEUGEOT / CITROEN)

Cristal Elevalunas / Glass Window

Familia 0300



162 856



162 857



162 901



162 936



162 808



163 380



163 176



164 088



163 596 *- Dcho
163 597 *- Izdo



163 588 *- Dcho
163 589 *- Izdo



163 590 *- Dcho
163 591 *- Izdo



163 660 *- Dcho
163 661 *- Izdo

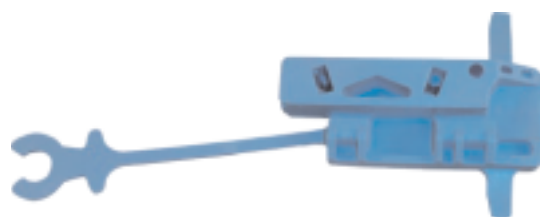

164 008 *- Dcho
164 009 *- Izdo

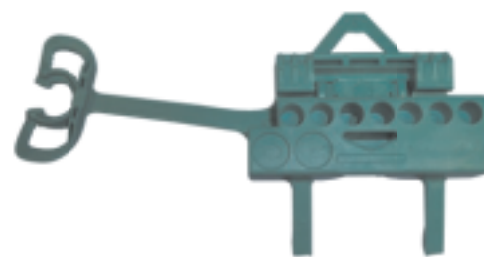

164 010 *- Dcho
164 011 *- Izdo



P.S.A. (PEUGEOT / CITROEN)

Cristal Elevalunas / Glass Window

Familia 0300

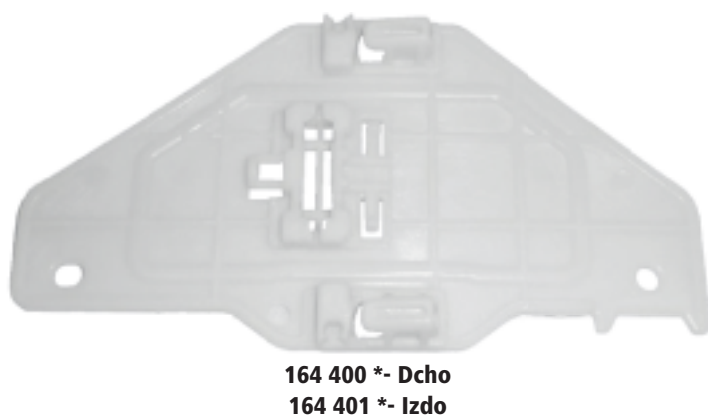
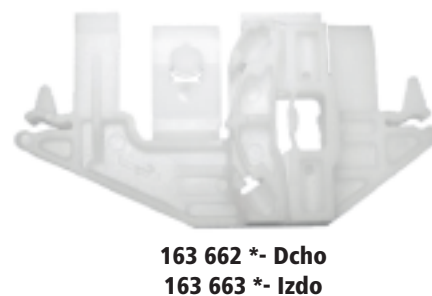
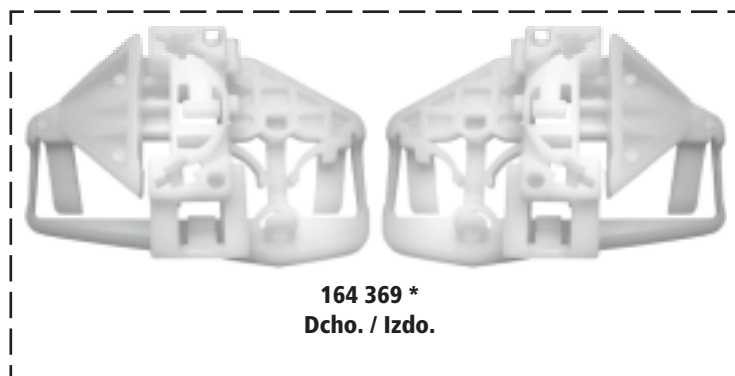
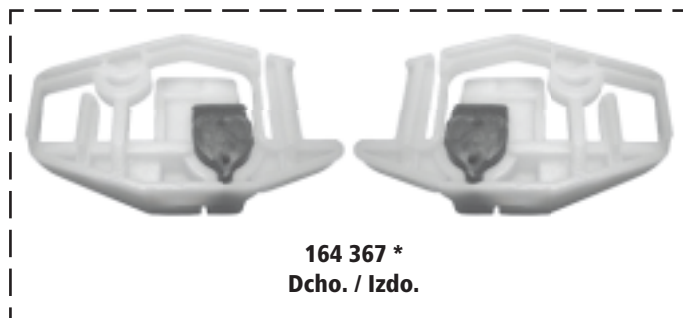
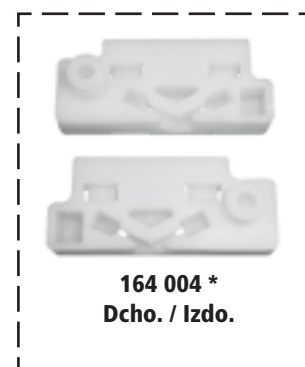
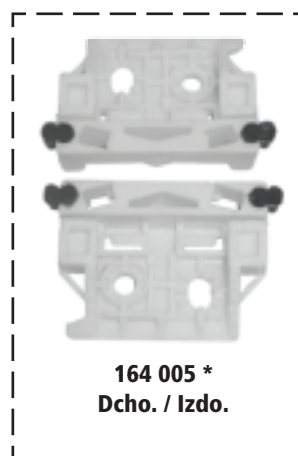
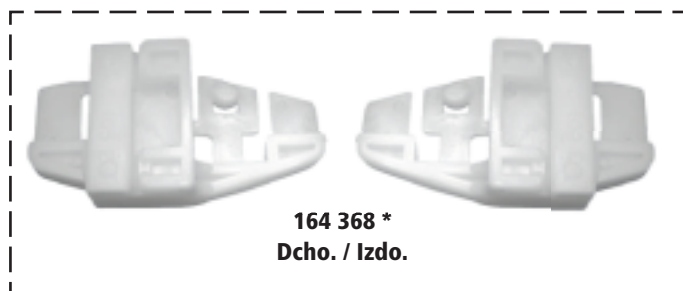

* (imagen 1/2 tamaño real)



P.S.A. (PEUGEOT / CITROEN)

Moldura puerta / Bodyside clips

Familia 0300

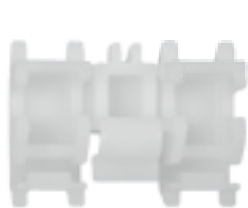

163 716

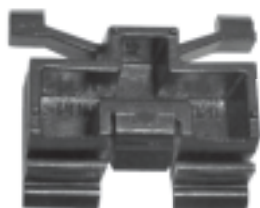

163 980



163 404



163 638



162 800



162 802



162 801



162 984



162 692



163 015



162 349



162 347



162 825



162 964



162 680



163 374



P.S.A. (PEUGEOT / CITROEN)

Moldura puerta / Bodyside clips

Familia 0300



162 430



162 876



163 052



162 370



162 501



162 804



163 944



163 870



163 871



162 805



162 816



162 967



163 309



163 872



163 874



164 293



164 160



164 016



164 164



P.S.A. (PEUGEOT / CITROEN)

Panel Puerta - Tapizados Interiores Door Panel - Interior Trim

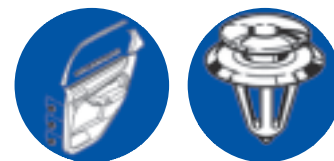

Familia 0300



162 229



162 981



162 855



162 372



162 667



162 714



162 633



162 978



163 905



162 987



162 988



162 989



162 848



162 849



162 850



P.S.A. (PEUGEOT / CITROEN)

Panel Puerta - Tapizados Interiores Door Panel - Interior Trim



Familia 0300





P.S.A. (PEUGEOT / CITROEN)

Botones Fijación / Buttons



Familia 0300



162 941



162 942



164 089



163 017



Ø 7

163 258



Ø 5

163 086



Ø 5,2

163 317



Ø 6

162 883



Ø 6,2

163 136



Ø 6,5

163 326



Ø 6,5

162 806



Ø 6,5

163 386



Ø 6,5

162 447



Ø 6,5

163 308



P.S.A. (PEUGEOT / CITROEN)

Botones Fijación / Buttons



Familia 0300



162 221
negro - black



162 222
gris - grey



162 320
blanco - white



162 453



162 660



162 454



162 935



163 630



162 657



163 087



162 441



164 294



163 886



164 092



163 201



162 440



162 934



164 059
negro - black



163 887



162 512



162 656



P.S.A. (PEUGEOT / CITROEN)

Juntas Puerta / Door Seals



Familia 0300



162 549



163 715



162 880



163 081



163 135



163 179

Varios Usos / Other Applications



Familia 0300

Ø 4,5



164 171

Ø 4,7



162 618

Ø 8



162 675

Ø 8,2



162 446

Ø 8,2



163 376

Ø 9



163 632

Ø 10,5



164 130

Tornillo M6

Ø 8,2



162 676

Ø 10



162 648



163 493



163 731



163 634



182 308*



163 724



163 725



163 375

* (imagen NO a tamaño real)



P.S.A. (PEUGEOT / CITROEN)

Tacos Plástico / Plastic Plugs



Familia 0300

7 x 7
Tornillo Ø 3,5



162 237

7 x 7
Tornillo Ø 4,2



162 244

7 x 7
Tornillo Ø 4,5



164 129

8 x 8



163 883

8 x 8
Tornillo Ø 4,8



162 887

8,2 x 8,2
Tornillo Ø 4,2



162 985

9 x 9
Tornillo Ø 5,5



163 165

10 x 15
Tornillo Ø 6,3



162 518

10 x 15
Tornillo Ø 6,3



162 371

10,8 x 11,2
Tornillo Ø 6,35



163 377

Tornillo Ø 5



164 102

7 x 12
Tornillo Ø 4,2



162 902

7 x 13
Tornillo Ø 4,2



162 523

7 x 14
Tornillo Ø 3,9



163 502

7 x 14
Tornillo Ø 3,9



163 222

7 x 14
Tornillo Ø 3,9



162 892

7 x 14



163 881

7 x 15
Tornillo Ø 3,9



163 882

7,2 x 14,2
Tornillo Ø 4,8



162 982



163 635



163 730



P.S.A. (PEUGEOT / CITROEN)

Remaches Plástico / Plastic Rivets



Familia 0300

Ø 3,5



162 431

Ø 4



163 717

Ø 5,5



162 456

Ø 5,5



163 299
negro - black

Ø 5,5



163 303
gris - grey

Ø 6



162 624

Ø 6



163 485

Ø 6,2



163 486

Ø 6



163 487

Ø 6,2



162 481

Ø 6,2



162 389

Ø 6,2



162 906

Ø 6,2



162 424

Ø 6,5



163 300

Ø 6,5



162 979



P.S.A. (PEUGEOT / CITROEN)

Remaches Plástico / Plastic Rivets



Familia 0300





RENAULT

Tornillos / Screws

Familia 0300



Ø 4,2 x 17
arandela Ø 14



162 702

Ø 4,5 x 13



161 778

Ø 4,5 x 16



161 777

Ø 5 x 17
arandela Ø 15



161 762

Ø 5 x 22
arandela Ø 16



161 750

Ø 6 x 20



161 721

Ø 6 x 26
arandela Ø 17



161 763

Ø M6 x 13



161 733

Ø M6 x 17,5



161 732

Ø M6 x 17



161 769

Ø M6 x 20



161 706

Ø M6 x 20
arandela Ø 18



161 727

Ø M6 x 20
arandela Ø 22



161 724

Ø M6 x 28
arandela Ø 24



161 731

Ø 6,3 x 15



161 432

Ø 6,3 x 16



162 478

Ø 6,3 x 18



162 490

Ø M7 x 15



161 728

Ø M8 x 22



162 619

Ø M8 x 20



161 705

Ø M8 x 26,5



161 729

Ø M6 x 25



161 450



RENAULT

Clips Metálicos / Metallic Clips



Familia 0300

Ø 2,9



161 447

Ø 3,5



162 591

Ø 4,2



161 779

Ø 4,2



162 635

Ø 4,2



161 427

Ø 4,8



161 496

Ø 6,3



161 449

Ø 6,3



162 634

Ø 6,3



161 437

Ø 6,35



162 479

Ø M6



161 725

Ø M6



161 726

Ø M5



161 703

Ø M5

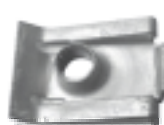

162 444

Ø M6



161 438

Ø M6

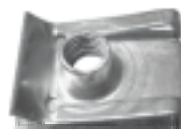

162 442

Ø M8



161 499



RENAULT

Clips Metálicos / Metallic Clips



Familia 0300

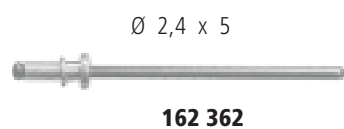



RENAULT

Faro / Headlight

Familia 0300

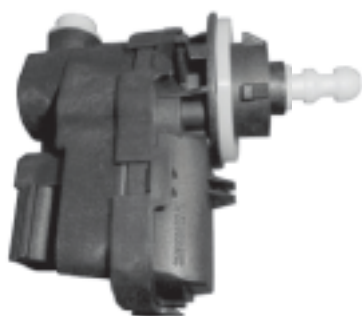

175 224*



175 225*

* (imagen 1/2 tamaño real)



163 340 - Dcho



163 019



163 126

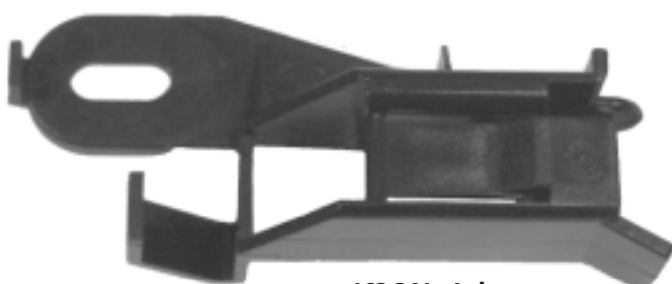

163 341 - Izdo



163 342 - Dcho



163 343 - Izdo



RENAULT

Bombas y Surtidor Lavaparabrisas Washer Pumps or Jets



Familia 0300



190 016



190 017



190 018



190 019



190 020



190 030



190 036



190 062



190 060



190 058



190 059



190 061



190 064



190 063



190 032



190 078



190 079



RENAULT

Bombas y Surtidor Lavaparabrisas / Washer Pumps or Jets



Familia 0300



190 361*



190 374*



190 375*



190 376*



190 377*



190 362*



190 388*



190 387*

* (imagen 1/2 tamaño real)



RENAULT

Moldura Techo - Parabrisas Roof - Windscreen Clips

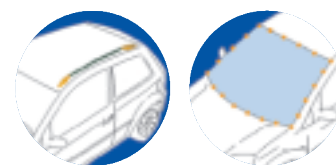

Familia 0300

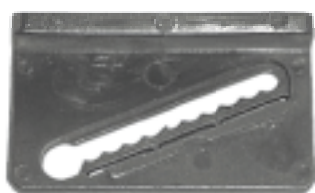

162 827



163 310



163 321



162 999



164 014

164 015



163 720



164 296



164 297



163 364



163 953



163 425



162 463



162 472



162 828



163 338



RENAULT

Moldura Parabrisas / Windscreen Clips

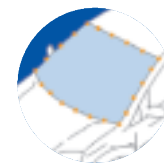

Familia 0300

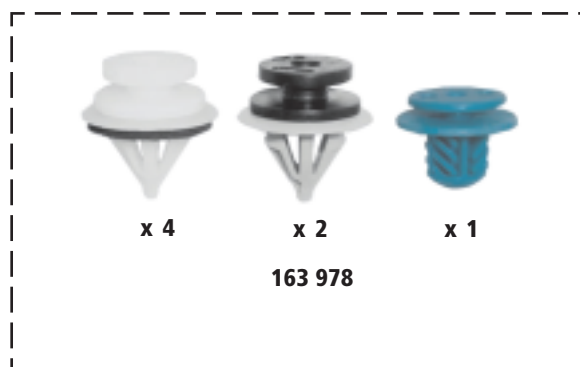
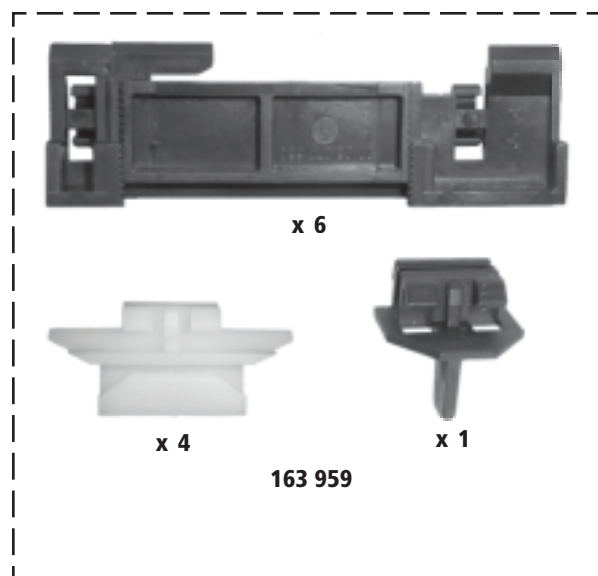



RENAULT

Cristal Elevation / Glass Window

Familia 0300



162 727



162 728



163 380



162 306

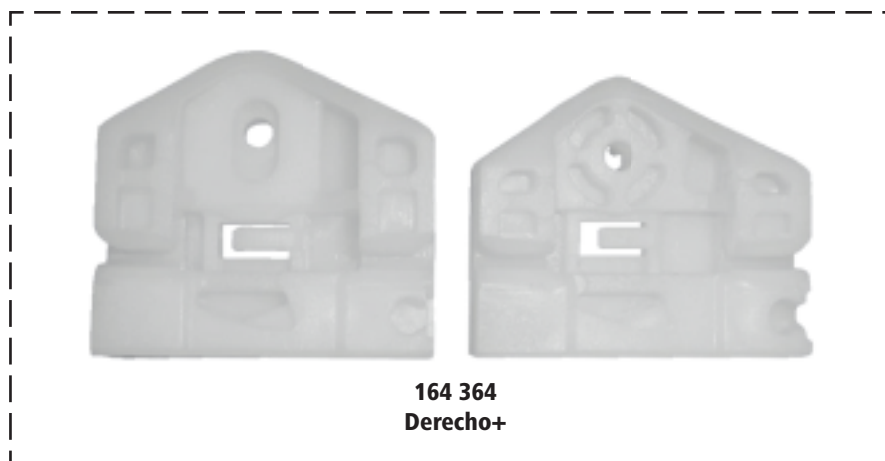

164 364
Derecho+

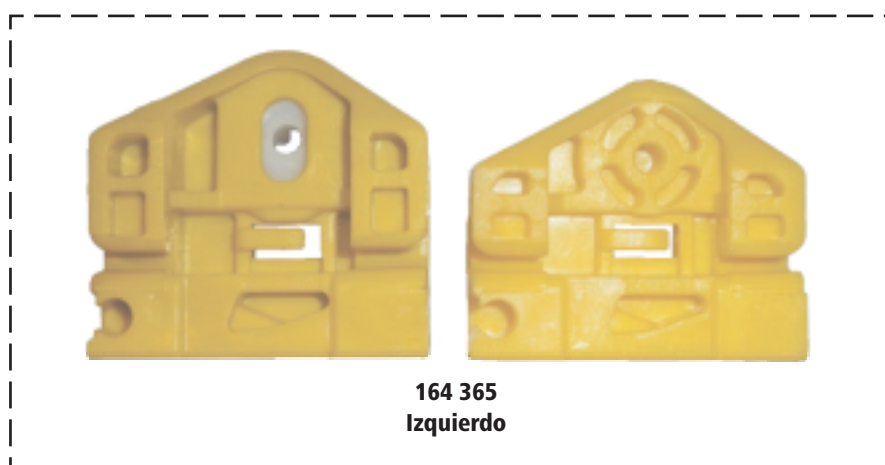

164 365
Izquierdo



164 398 - Dcho
164 399 - Izdo

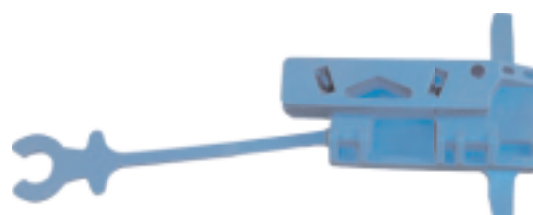

164 008 *- Dcho
164 009 *- Izdo



RENAULT

Cristal Elevalunas / Glass Window

Familia 0300

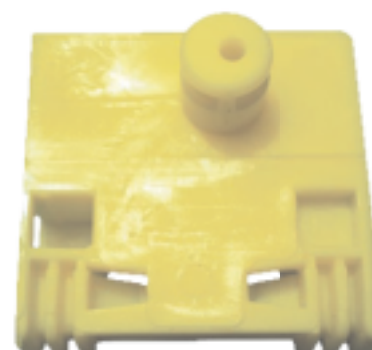
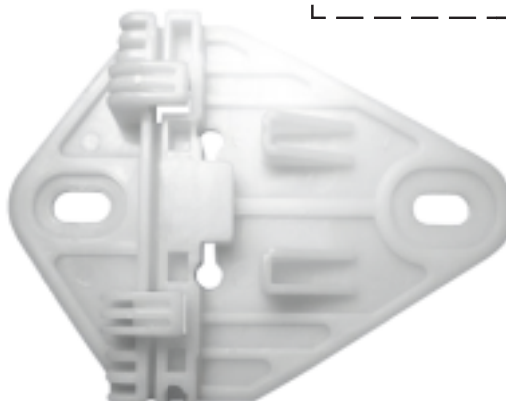
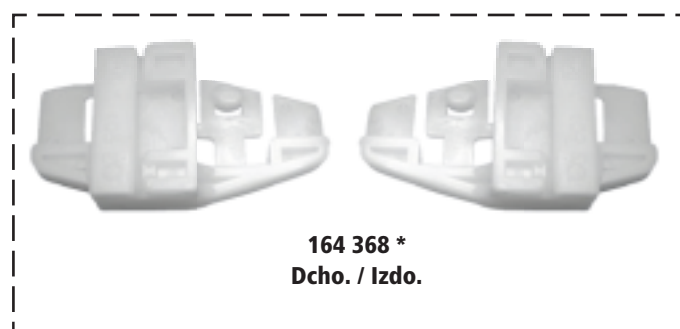
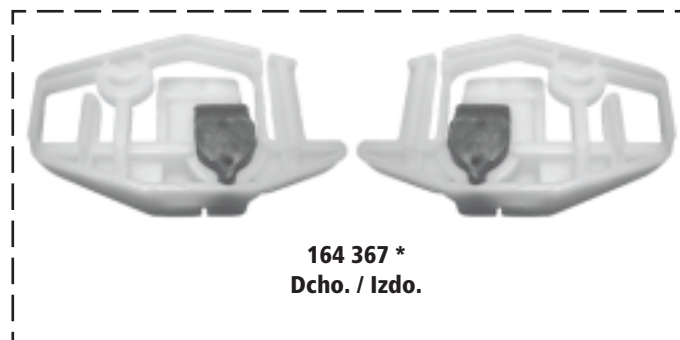
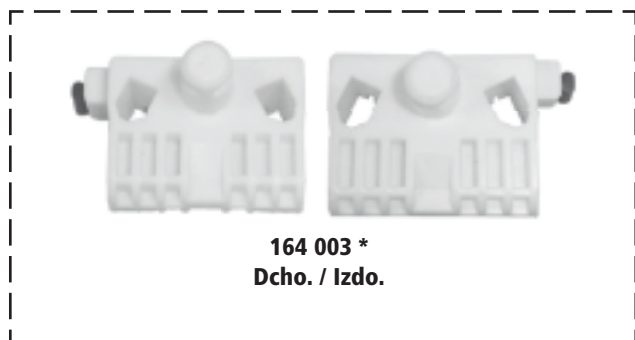

* (imagen 1/2 tamaño real)



RENAULT

Varios Usos / Other Applications



Familia 0300

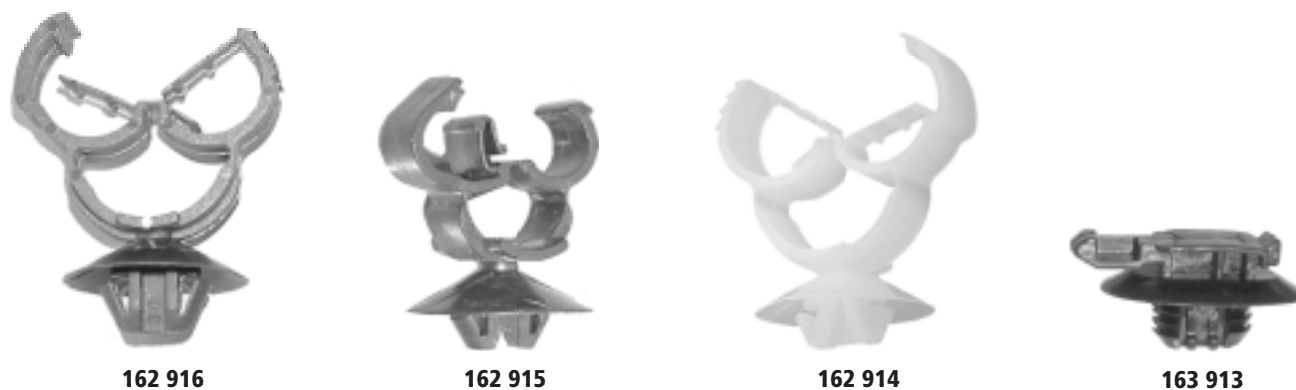

182 310*



182 314*

* (imagenes NO a tamaño real)



RENAULT

Parachoque - Pasorueda - Aletas
Bumper - Wheel Arch - Wings



Familia 0300



162 829



163 137



163 324



163 363



163 320



162 694



163 202



163 203



163 383

7700 412 158

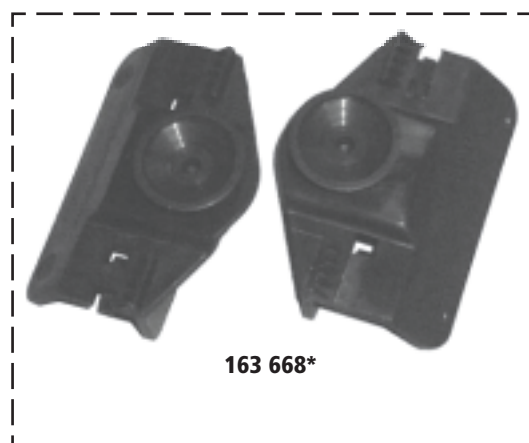

163 668*



164 350 *- Dcho/lzdo

* (imagen 1/2 tamaño real)



RENAULT

Rejilla o Capó / Front Grille or Hood



Familia 0300



164 381

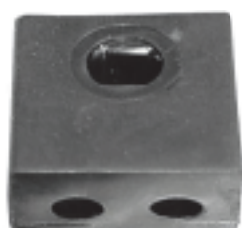

162 721



164 386



163 665

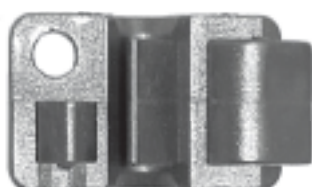

162 722



163 224



163 885



163 366



163 138



162 723



162 724



163 223



163 471



162 932



163 214



163 215



164 104



RENAULT

Juntas Puerta / Door Seals



Familia 0300



Varilla Cerradura Puerta / Door Locking



Familia 0300

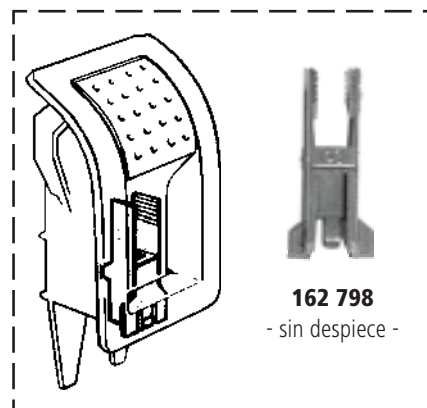
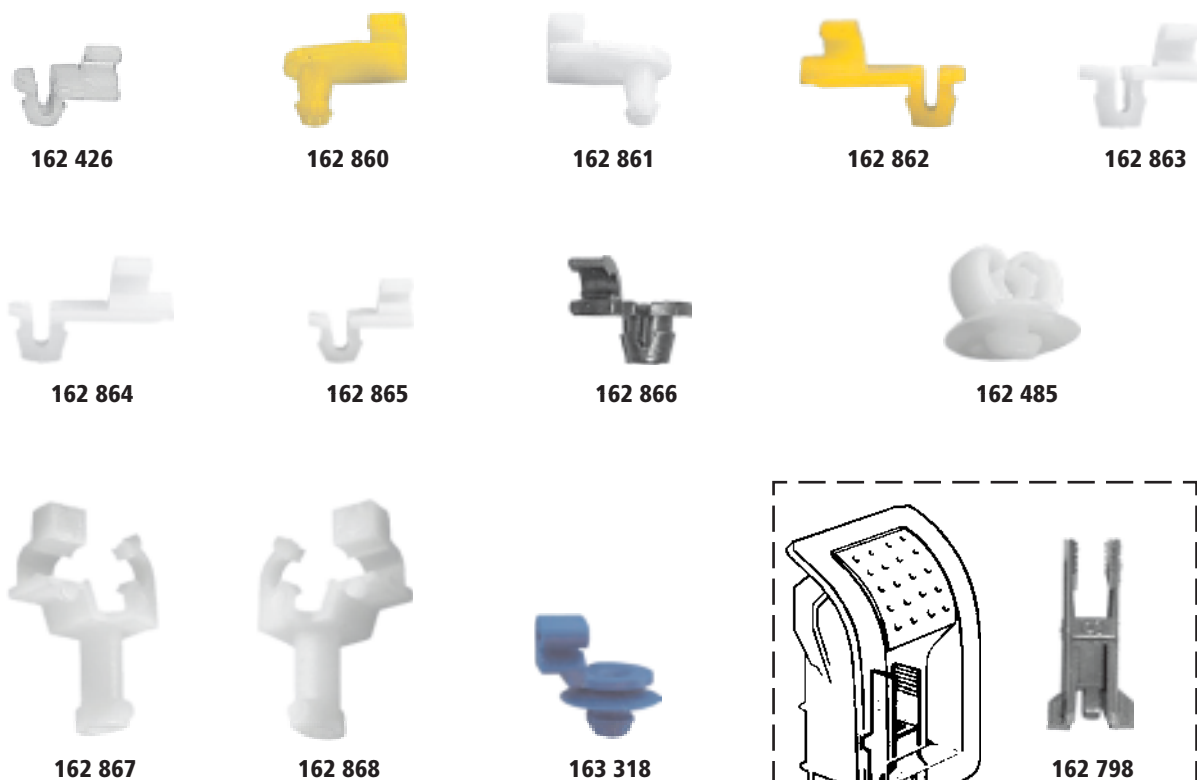



RENAULT

Moldura puerta / Bodyside clips

Familia 0300



162 462

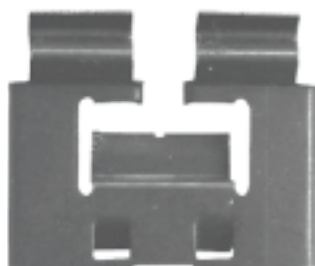

162 327



162 681



162 682



162 996



162 473



162 474



162 488



162 489



162 687

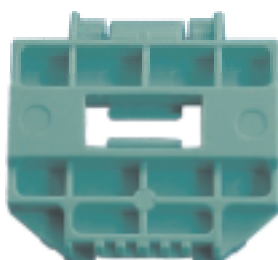

162 683



162 684



162 685



162 686



RENAULT

Moldura puerta / Bodyside clips

Familia 0300



163 144



163 504



163 083



(pieza anterior
sustituida)



162 967



163 714



163 718



163 719



161 423



163 446



164 096



163 444



163 445



162 962



162 997



162 995



162 992



162 993



162 994



162 824



RENAULT

Panel Puerta - Tapizados Interiores Door Panel - Interior Trim

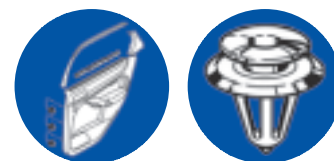

Familia 0300



162 672



163 043



163 092



163 876



164 301



163 382



163 115



163 381



6 x 7

162 673



6 x 7

162 451



7,5 x 8

162 452



162 668



162 669



162 234



162 998



∅ 8,5

162 675



∅ 10

162 648



161 424

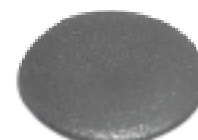

162 912

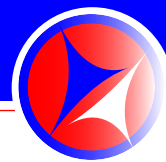

RENAULT

Panel Puerta - Tapizados Interiores Door Panel - Interior Trim



Familia 0300



163 139

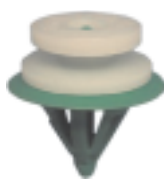

163 142



163 145



163 379



161 422



162 961



162 826



163 141



162 816



163 858



163 891



163 453



163 082



163 083



(pieza anterior
sustituida)



163 669



162 229



162 372



163 595



RENAULT

Botones Fijación / Buttons

Familia 0300



162 705



162 450



163 447



163 385



162 875



163 327



162 975



162 823



162 643



163 879



163 006



163 007



RENAULT

Botones Fijación / Buttons

Familia 0300





RENAULT

Tacos Plástico / Plastic Plugs



Familia 0300

7 x 13
Tornillo Ø 4,2



162 523

7 x 14



163 881

7 x 14
Tornillo Ø 3,9



163 502

7 x 14
Tornillo Ø 3,9



163 222

7 x 14
Tornillo Ø 4,2



162 483

7 x 15
Tornillo Ø 3,9



163 882

8 x 11,6
Tornillo Ø 5,5



164 101

12 x 15



164 361

7 x 7
Tornillo Ø 3



162 238

7 x 7
Tornillo Ø 3,5



162 717

7,2 x 7,2
Tornillo Ø 3,5



163 426

8 x 8
Tornillo Ø 4



162 903

8 x 8
Tornillo Ø 4,2



163 427

8 x 8



163 883

8 x 8
Tornillo Ø 4,8



162 468

8,5 x 8,5
Tornillo Ø 4



162 649



RENAULT

Remaches Plástico / Plastic Rivets



Familia 0300



163 226



163 717



163 926



162 647



162 259



162 456



163 819



163 140



163 487



162 481



163 486



162 424



163 328



163 306



163 384



163 091



163 448



164 230



163 449



163 088



164 254

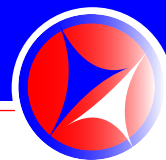

ROVER / LAND ROVER

Familia 0300



190 369*



163 656* - Dcho
163 657* - Izdo

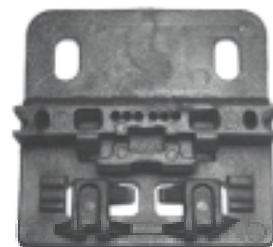

163 658*
Dcho. / Izdo.

* (imagen 1/2 tamaño real)



163 123



163 131



163 132



163 333



164 194



164 195



164 302



164 147



164 148



ROVER / LAND ROVER

Familia 0300



162 947



163 639



164 018



164 067



164 354



163 754



164 170



163 141



164 123



164 035



164 066



164 074



164 075



163 417

Ø 6



163 044

Ø 6,2



163 169

Ø 6,5



164 313

Ø 7,5



164 193

Ø 8



164 063

Ø 8



164 192

Ø 8



163 035

8 x 8



163 036

Ø 8



163 091

Ø 10



163 037

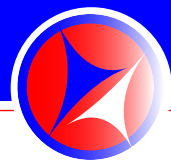

SEAT (antiguos)

Tornillos - Clips Metálicos / Screws - Metalic Clips



Familia 0300



Parachoque / Bumper

Familia 0300





SEAT (antiguos)

Varios Usos / Other Applications



Familia 0300



162 640



162 641



162 325



162 541



162 571



162 542



162 427



164 378

* (imagen NO a tamaño real)



181 403*



190 021



190 022



162 273



162 538



162 520



162 532



162 568



SEAT (antiguos)

Cristal Elevalunas / Glass Window



Familia 0300



162 565 *- Dcho
162 566 *- Izdo



162 307



181 400*



181 431*



181 401*



181 432 *- Del Dcha
181 433 *- Del Izda
181 434 *- Tras Dcha
181 435 *- Tras Izda

* (imagen 1/2 tamaño real)

Panel Puerta - Tapizados Interiores Door Panel - Interior Trim



Familia 0300



162 598



162 405



162 402



162 553



162 713



162 378



162 599



162 615



162 551



162 493



Ø 6,5

162 823



Ø 8

162 579
gris



Ø 8

162 580
negro



SEAT (antiguos)

Moldura puerta / Bodyside clips

Familia 0300



162 563



162 428



162 360



162 557



162 679

Tacos Plástico / Plastic Plugs

Familia 0300



6 x 6
Tornillo Ø 3



162 326

7 x 7
Tornillo Ø 3



162 609

7 x 7
Tornillo Ø 3



162 238

7 x 7
Tornillo Ø 3,5



162 240

7 x 7
Tornillo Ø 3



162 401



162 610

8 x 8
Tornillo Ø 4,5



162 534

10 x 10
Tornillo Ø 4



162 545

10 x 10
Tornillo Ø 3,5



162 241



162 492



162 491



162 449



162 499



162 608



162 558

8 x 8
Tornillo Ø 3,5



162 242

10 x 10
Tornillo Ø 4,8



162 243

11 x 11
Tornillo Ø 5



162 457



162 247



162 248



162 494



162 533



SMART

Familia 0300



190 355*



173 080

* (imagen 1/2 tamaño real)



163 339



164 027



163 485



Ø 6
cabeza Ø 15

163 044



tornillo Ø 5

163 830

8 x 8
Tornillo Ø 4



164 124



SUBARU

Familia 0300



190 363*

* (imagen 1/2 tamaño real)

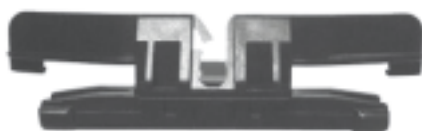

163 479



164 355



163 161



164 242



164 221



164 427



164 426



163 477



163 478



Ø 6,5

163 300



Ø 10

163 276



SUZUKI

Bombas y Surtidor Lavaparabrisas / Washer Pumps or Jets



Familia 0300



190 365*



190 363*

* (imagen 1/2 tamaño real)

Moldura Parabrisas / Windscreen Clips

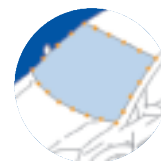

Familia 0300



164 419



163 248



Ø 6,5

163 300



163 852



163 866

Moldura puerta / Bodyside clips



Familia 0300



164 285



164 423



SUZUKI

Panel Puerta - Tapizados Interiores Door Panel - Interior Trim

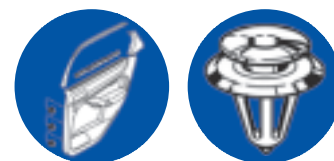

Familia 0300



163 161



163 509



163 250



163 531



163 616



163 514



163 617



163 513



163 510



163 512

Remaches Plástico / Plastic Rivets



Familia 0300

Ø 6,5



163 300

Ø 6,5



163 301

Ø 6,5



163 475

Ø 7



163 302

Ø 7



163 476

Ø 7,5



164 153

Ø 15



163 814

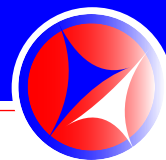

TOYOTA

Tornillos / Screws

Familia 0300



Ø 5 x 17
arandela Ø 16



161 835

Ø 6,3 x 16
arandela Ø 16



161 829

Ø 6,3 x 20
arandela Ø 20



161 827

Ø 6,3 x 24
arandela Ø 16



161 820

Bombas y Surtidor Lavaparabrisas / Washer Pumps or Jets

Familia 0300



190 365*



190 363*



190 041

* (imagen 1/2 tamaño real)

Faro / Headlight

Familia 0300

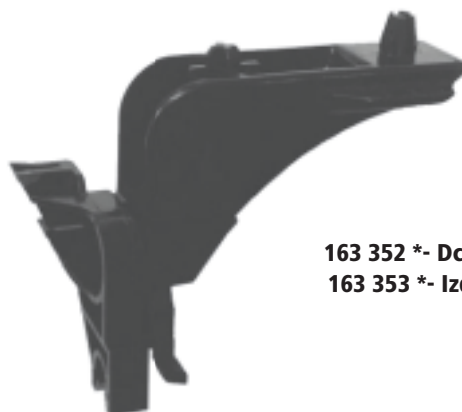

163 352 *- Dcho
163 353 *- Izdo

* (imagen 1/2 tamaño real)



TOYOTA

Moldura Parabrisas / Windscreen Clips

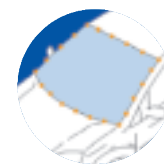

Familia 0300



163 706



163 130



163 359



164 417



164 020



163 122



164 019



163 859



163 300

Rejilla o Capó / Front Grille or Hood



Familia 0300



163 246



163 159



163 355



164 206

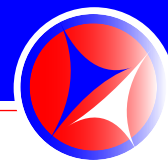

TOYOTA

Parachoque / Bumper

Familia 0300



163 523*



163 524*



163 525*



163 895



164 186



164 188



164 291



164 241

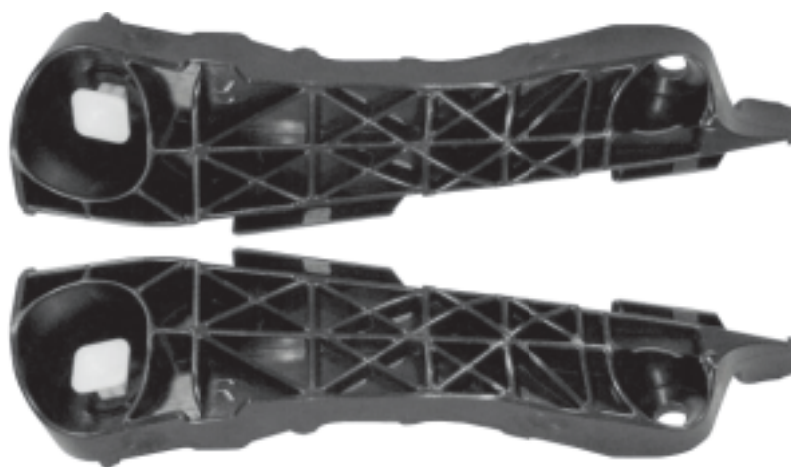

164 338 *- Dcho

164 339 *- Izdo

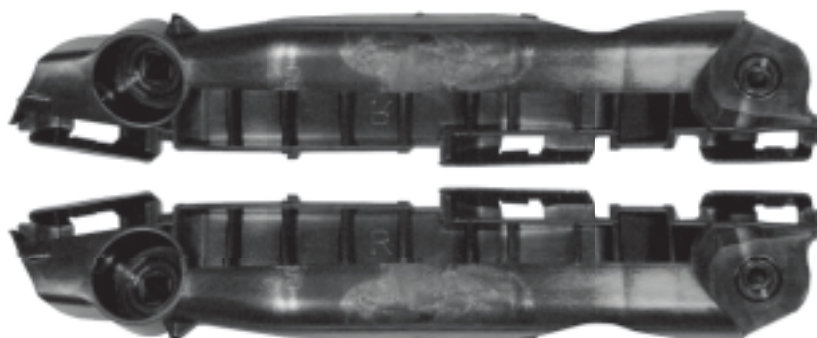

164 348 *- Dcho

164 349 *- Izdo

* (imagen 1/2 tamaño real)



TOYOTA

Tacos Plástico / Plastic Plugs



Familia 0300

9 x 9
Tornillo Ø 4,2



163 619

9 x 9
Tornillo Ø 5,5



163 256

9 x 9
Tornillo Ø 5,5



163 622

9 x 11
Tornillo Ø 5,5



164 290

8 x 8
Tornillo Ø 5,5



163 894

9 x 9
Tornillo Ø 5,5



163 165

9 x 9
Tornillo Ø 5,5



164 091

8,8 x 9
Tornillo Ø 6,3



164 305



164 298



163 121



163 255



8,5 x 8,5
Tornillo Ø 4,8
163 520



163 160



164 397



TOYOTA

Moldura puerta / Bodyside clips

Familia 0300



163 935



163 936



163 937



163 938



163 939



163 940



164 244



164 245



163 527



163 248



163 933



163 934



163 941



163 942



163 932



163 247



163 931



163 526



163 982



164 420



164 431



TOYOTA

Panel Puerta - Tapizados Interiores Door Panel - Interior Trim



Familia 0300



163 532



163 253



163 162



163 533



163 534



164 242



163 161



164 395



164 421



163 354



163 621



164 430



163 531



163 620



163 250



163 528



163 251



163 254



163 356



163 535



TOYOTA

Botones Fijación / Buttons



Familia 0300

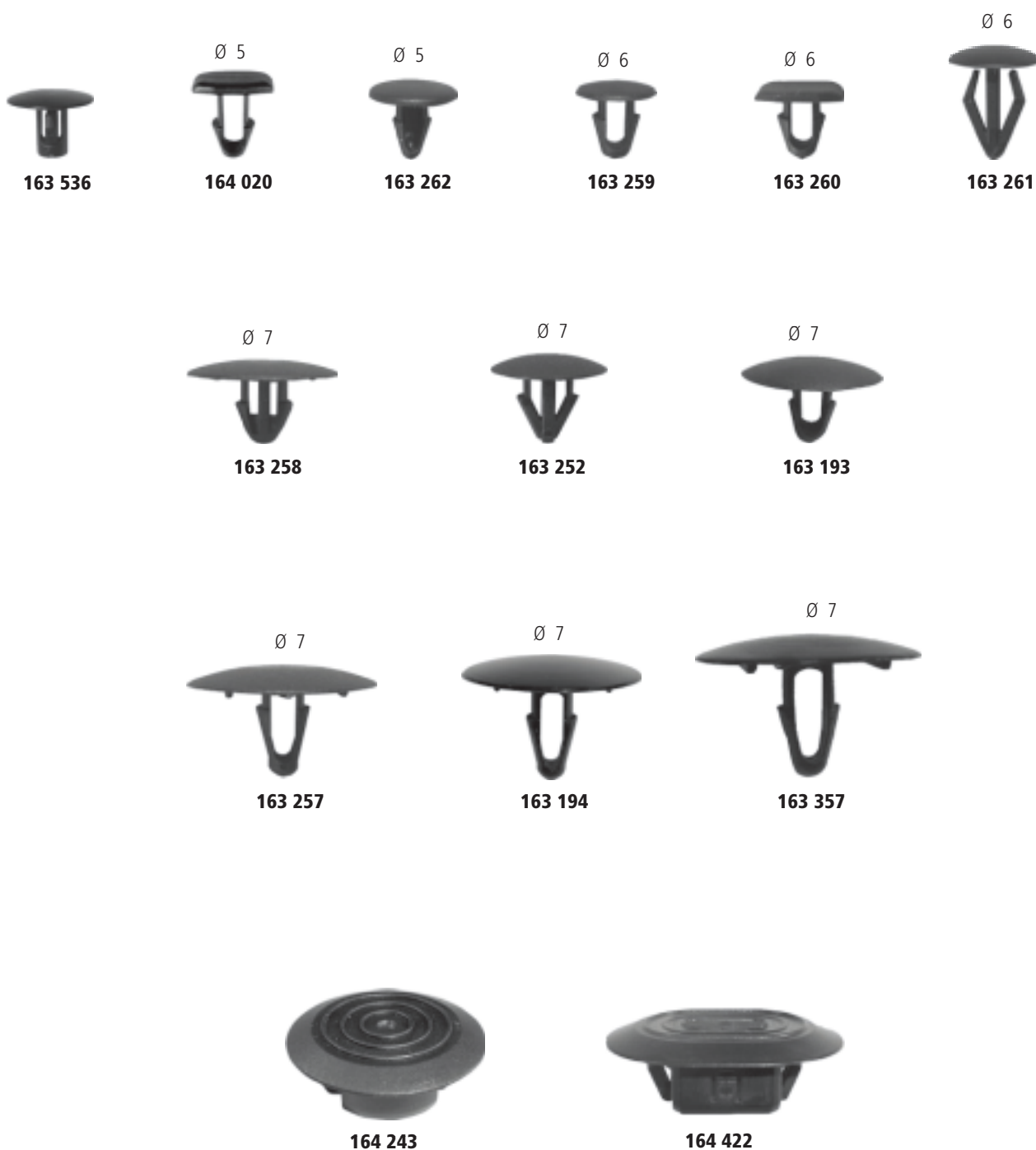



TOYOTA

Remaches Plástico / Plastic Rivets



Familia 0300

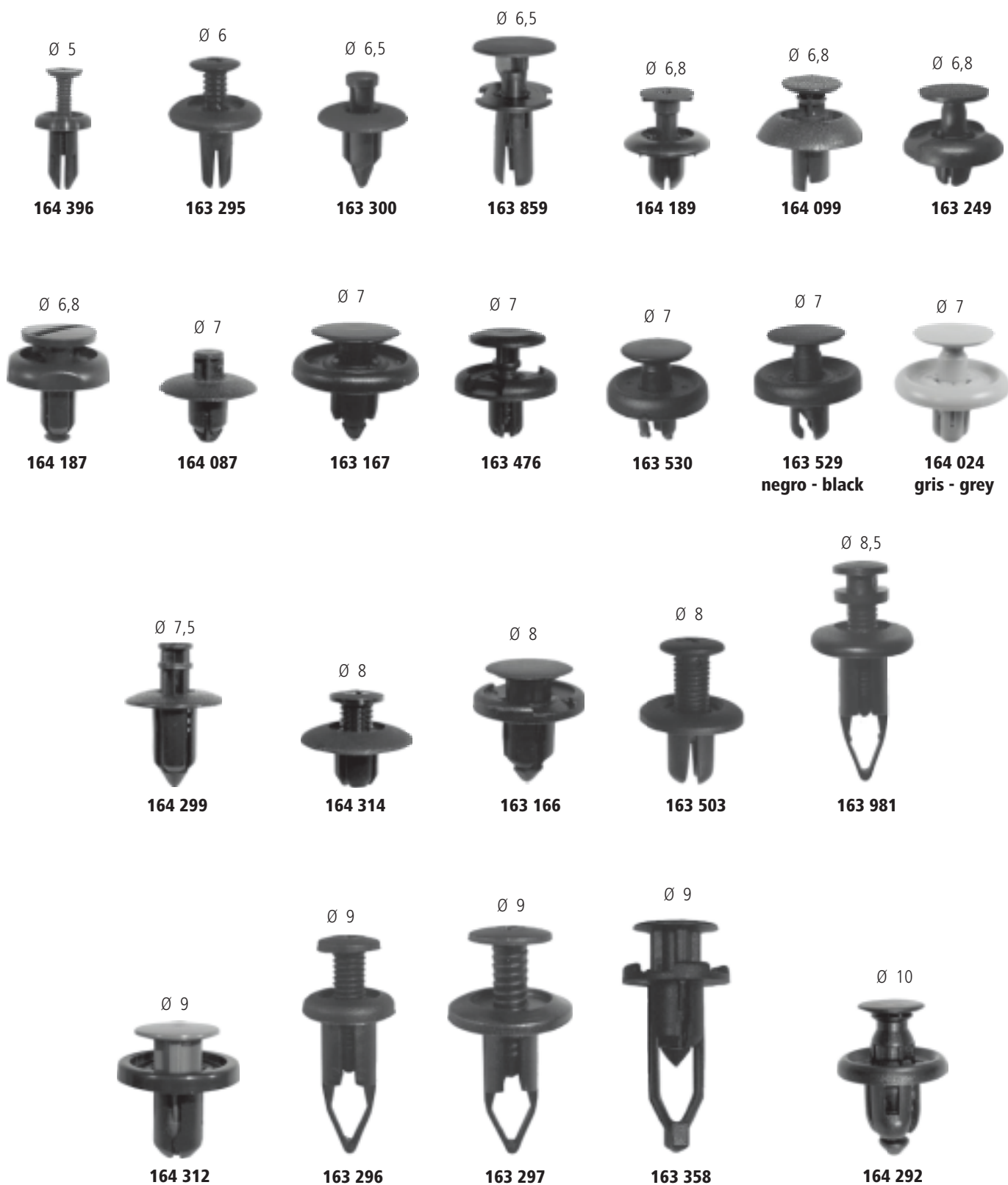



V.A.G. (AUDI / SEAT / SKODA / VW)

Tornillos - Clips metálicos / Screws - Metalic Clips



Familia 0300

Ø 4,2 x 17
arandela Ø 14



162 702

Ø 4,8 x 15



161 477

Ø 4,8 x 15
arandela Ø 15



161 473

Ø 4,8 x 18
arandela Ø 15



161 474

Ø 5 x 16



161 764

Ø 5 x 16



161 789

Ø 5,5 x 19
arandela Ø 18



162 555

Ø 5,5 x 19
arandela Ø 22



161 742

Ø 6,3 x 18
arandela Ø 18



161 799

Ø 6,3 x 19
arandela Ø 18



162 556

Ø 6,3 x 19
arandela Ø 22



161 743

Ø M6 x 12
arandela Ø 18



161 798

Ø M6 x 19



161 486

Ø M6 x 27



162 397

Ø 2,4 x 5



162 362



V.A.G. (AUDI / SEAT / SKODA / VW)

Tornillos - Clips metálicos / Screws - Metallic Clips



Familia 0300



161 765



161 482



161 836



161 819



161 791



161 830



161 768

Tornillo Ø 4,2



161 459

Tornillo Ø 4,8



161 808

Tornillo Ø 6,3



161 460

Tornillo Ø 6,3



161 755



161 818



161 817



161 429



162 711



162 712



162 904



163 372



163 544

cabeza Ø 14
agujero Ø 7
tornillo Ø 5

cabeza Ø 13
agujero Ø 7
tornillo Ø 5

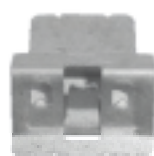

161 838



161 735



161 770



163 071



161 766



V.A.G. (AUDI / SEAT / SKODA / VW)

Tornillos - Clips Metálicos / Screws - Metalic Clips



Familia 0300

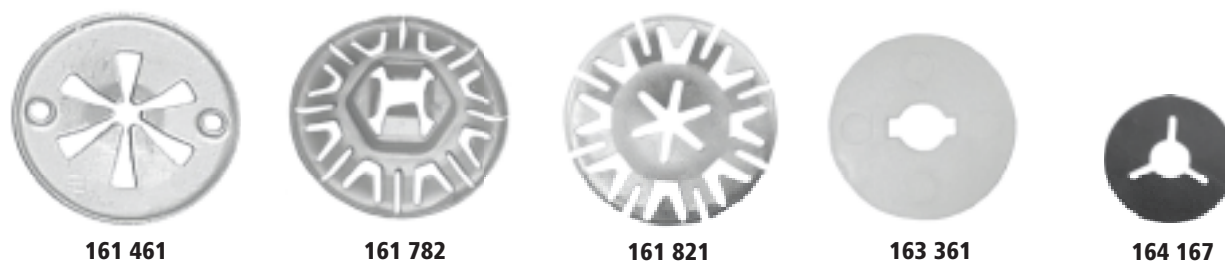
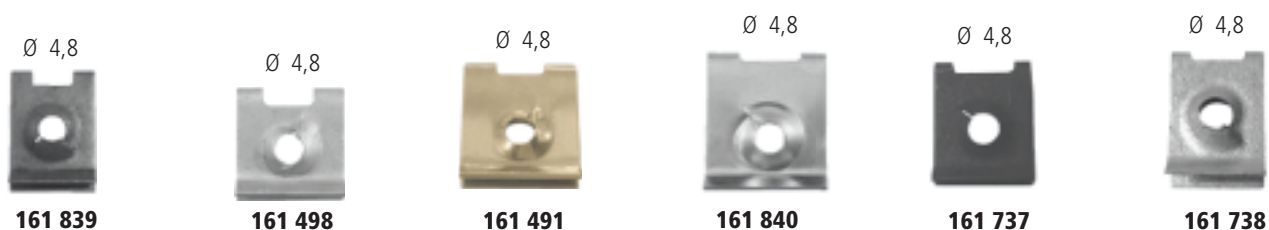



V.A.G. (AUDI / SEAT / SKODA / VW)

Tornillos - Clips Metálicos / Screws - Metalic Clips

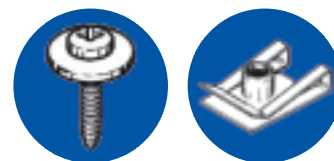

Familia 0300



161 707



161 708



161 712



161 713



161 780



161 709



161 711



161 772



161 792

Tornillos - Clips Plástico / Screws - Plastic Clips

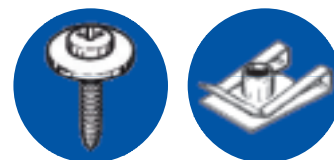

Familia 0300



163 228



163 227



163 319



163 540



164 070



164 166



164 083



164 229



V.A.G. (AUDI / SEAT / SKODA / VW)

Parachoque / Bumper

Familia 0300



164 316 *- Dcho
164 317 *- Izdo



164 318 *- Dcho
164 319 *- Izdo



164 320 *- Dcho
164 321 *- Izdo



164 322 *- Dcho
164 323 *- Izdo



164 330 *- Dcho
164 331 *- Izdo

* (imagen 1/2 tamaño real)



V.A.G. (AUDI / SEAT / SKODA / VW)

Parachoque / Bumper

Familia 0300



164 324 *- Dcho
164 325 *- Izdo

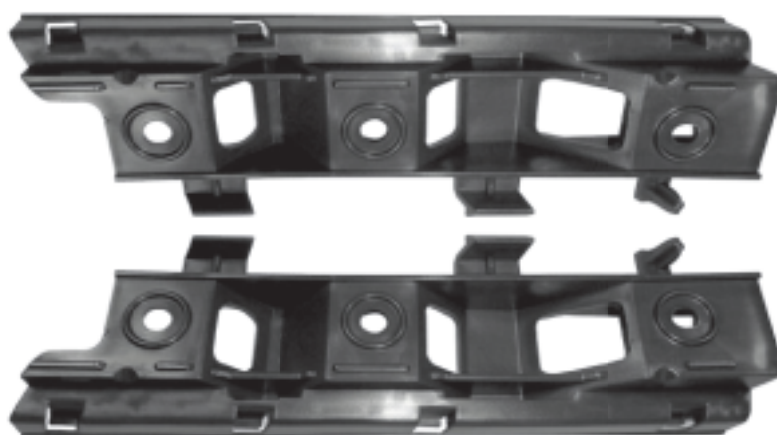

164 326 *- Dcho
164 327 *- Izdo



164 328 *- Dcho
164 329 *- Izdo

* (imagen 1/2 tamaño real)



V.A.G. (AUDI / SEAT / SKODA / VW)

Parachoque / Bumper

Familia 0300



162 295*



162 969*



164 268



163 000 *- Dcho
163 001 *- Izdo

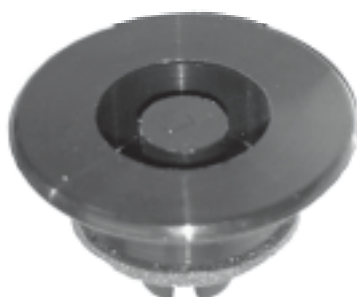

162 403



162 317



163 738*



163 739*

* (imagen 1/2 tamaño real)



V.A.G. (AUDI / SEAT / SKODA / VW)

Bombas y Surtidor Lavaparabrisas Washer Pumps or Jets



Familia 0300



190 352*



190 353*



190 354*



190 355*



190 368*



190 371*



190 372*



190 378*



190 379*

* (imagen 1/2 tamaño real)



190 031



V.A.G. (AUDI / SEAT / SKODA / VW)

Faro / Headlight



Familia 0300

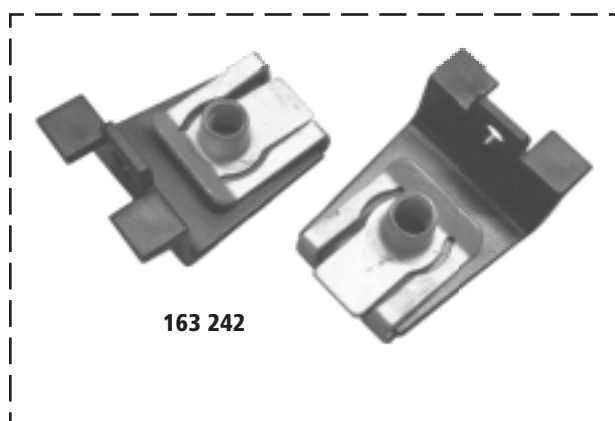
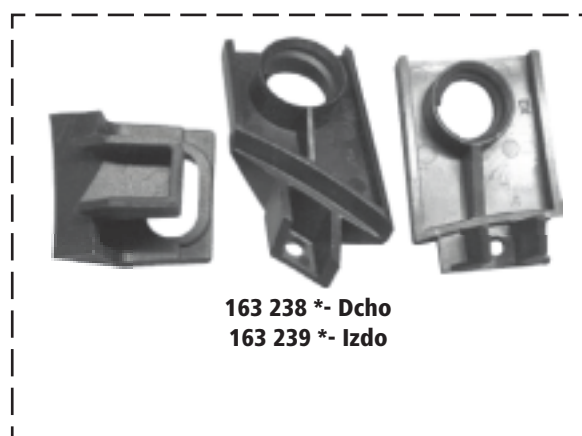
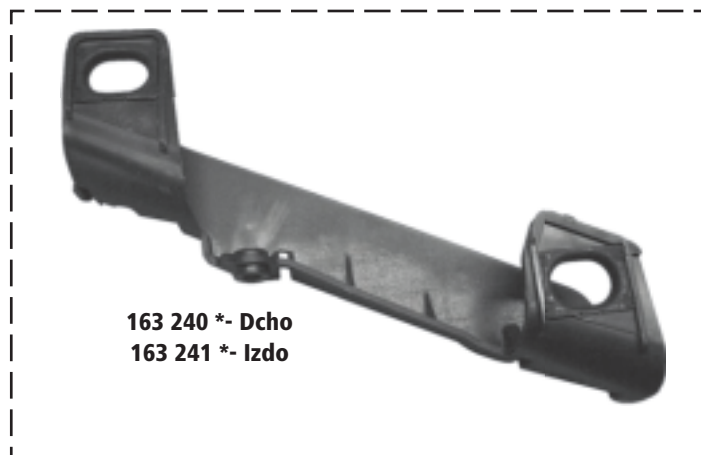
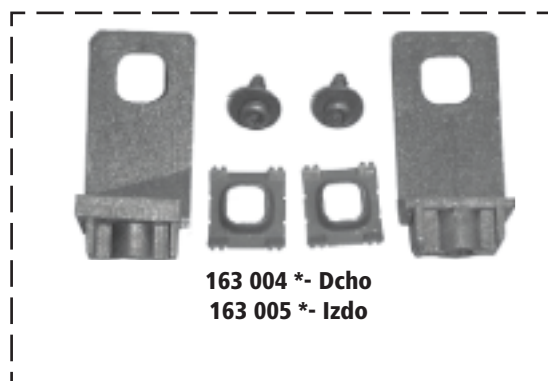

* (imagen 1/2 tamaño real)



V.A.G. (AUDI / SEAT / SKODA / VW)

Faro / Headlight

Familia 0300



173 080



173 196



178 098



173 197



162 720

Tornillo Ø 5



163 428

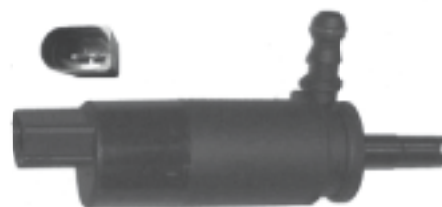

190 382*

* (imagen 1/2 tamaño real)

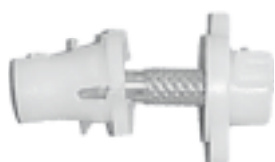

162 292

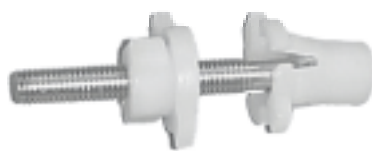

162 293



162 294



V.A.G. (AUDI / SEAT / SKODA / VW)

Varios Usos / Other Applications



Familia 0300



162 708



162 267



163 075



163 076



164 026



163 208



163 190



164 384



181 410*



181 405*

* (imagen NO a tamaño real)

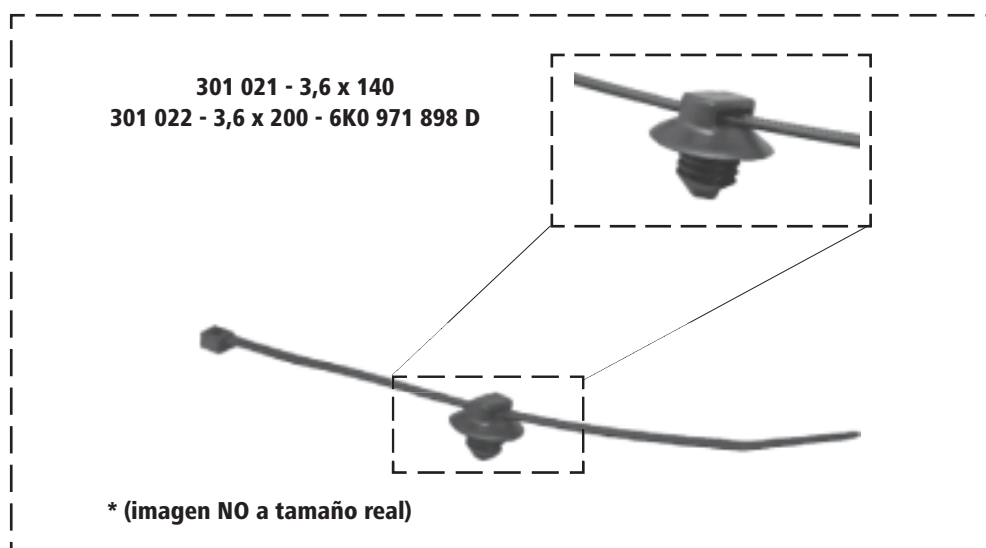



V.A.G. (AUDI / SEAT / SKODA / VW)

Moldura Parabrisas / Windscreen Clips

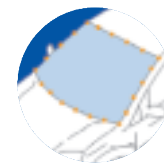

Familia 0300



162 689



162 690



162 990



162 991



163 709



163 710



163 637



163 850



162 787



163 545



162 370



162 759



162 760



164 017



163 020



162 765



163 726



164 030



164 031



V.A.G. (AUDI / SEAT / SKODA / VW)

Rejilla o Capó / Front Grille or Hood



Familia 0300



163 050



162 504



162 920



164 077



163 049



163 187



162 506



162 762



163 175



164 259



162 329



164 379



162 834



162 768



164 383



163 189



162 840



162 854

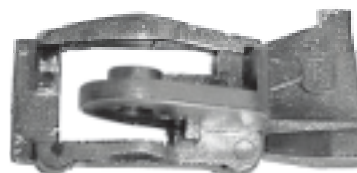

162 763



162 764



V.A.G. (AUDI / SEAT / SKODA / VW)

Rejilla o Capó / Front Grille or Hood



Familia 0300



162 845



162 846



163 543



164 098

Juntas Puerta / Door Seals



Familia 0300

Ø 5,5



162 844



163 396



164 028



163 834



164 077



163 835



164 131



163 687



164 037



164 165



163 875



164 169



163 232



163 231



163 346



163 206



163 824

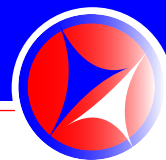

V.A.G. (AUDI / SEAT / SKODA / VW)

Cristal Elevalunas / Glass Window

Familia 0300



163 031 *



164 001 *



164 000 *



163 002 *

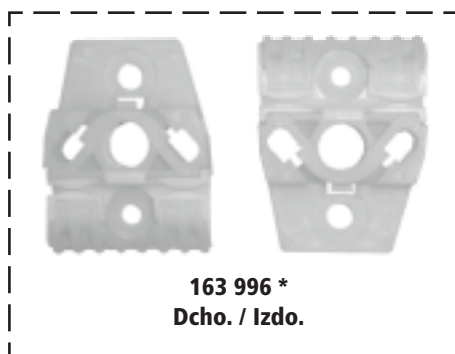

163 996 *
Dcho. / Izdo.

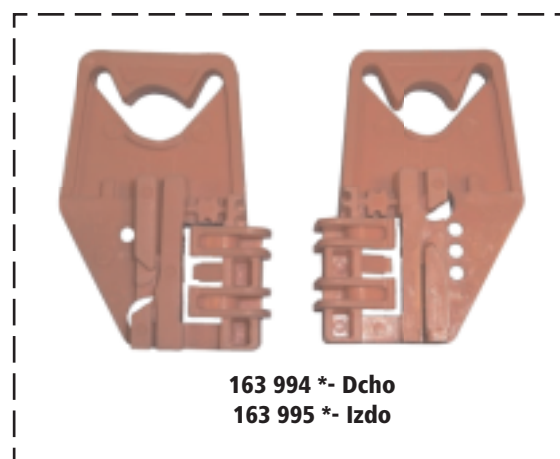

163 994 *- Dcho
163 995 *- Izdo

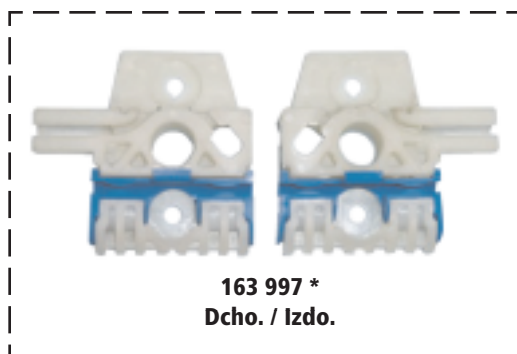

163 997 *
Dcho. / Izdo.

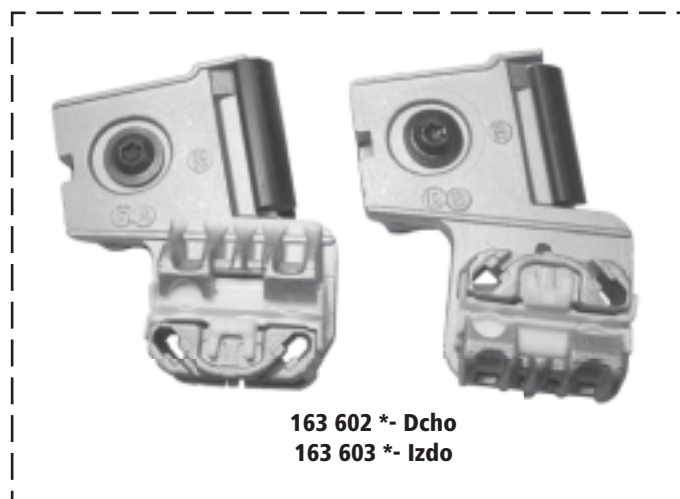

163 602 *- Dcho
163 603 *- Izdo



163 664 *
Dcho. / Izdo.

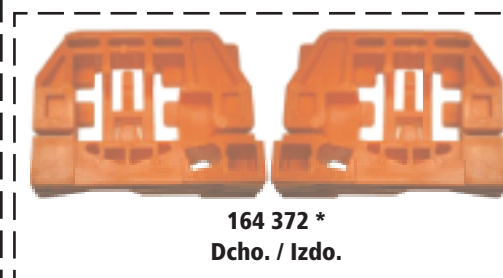

164 372 *
Dcho. / Izdo.

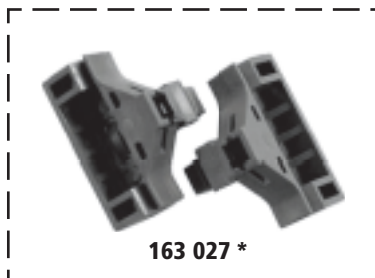

163 027 *

* (imagen 1/2 tamaño real)



V.A.G. (AUDI / SEAT / SKODA / VW)

Cristal Elevation / Glass Window

Familia 0300

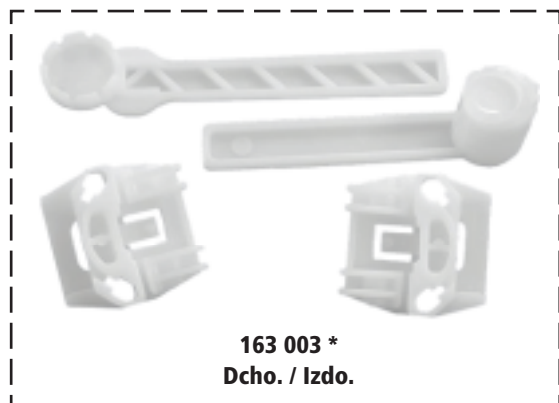
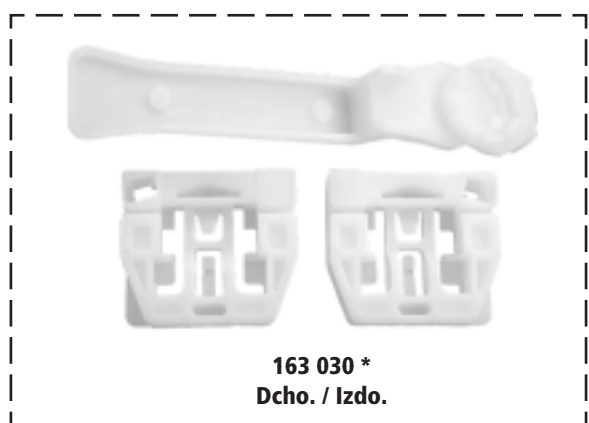
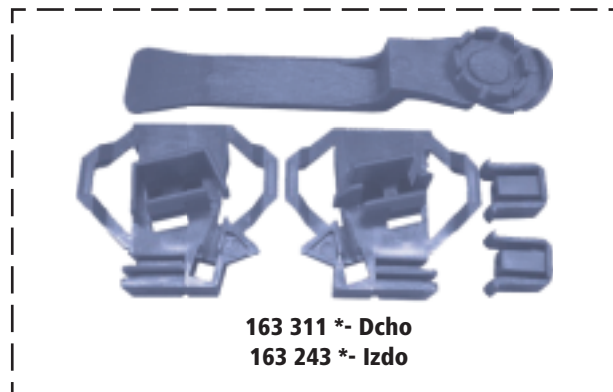
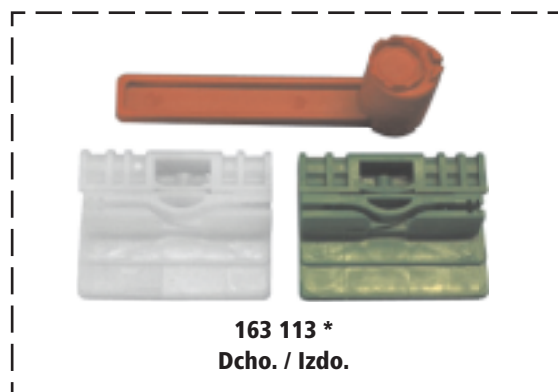
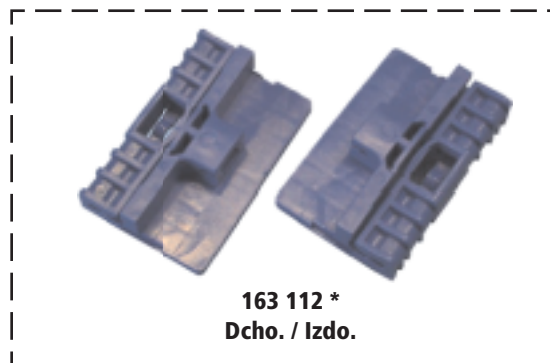
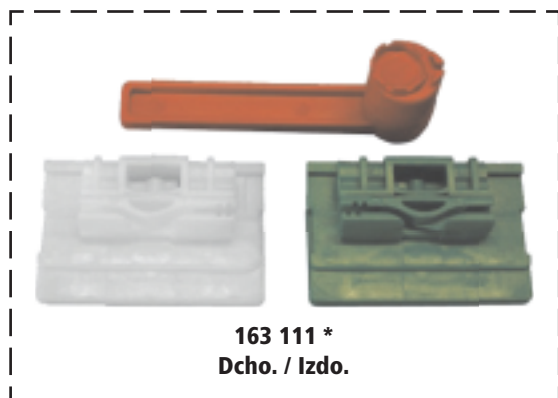

* (imagen 1/2 tamaño real)



V.A.G. (AUDI / SEAT / SKODA / VW)

Cristal Elevelunas / Glass Window



Familia 0300

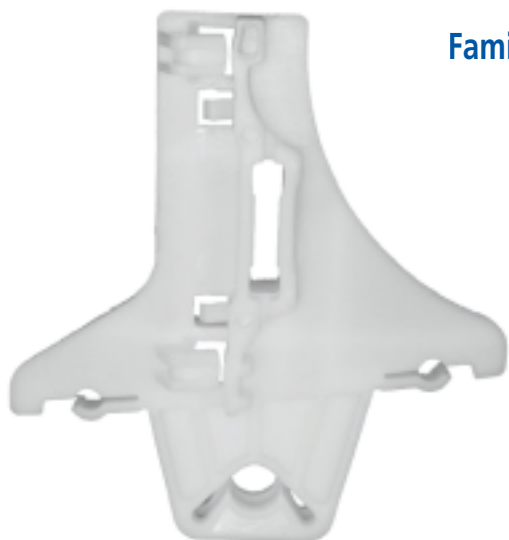

163 998 *- Dcho
163 999 *- Izdo



163 604 *- Dcho
163 605 *- Izdo



163 564 *- Dcho
163 565 *- Izdo

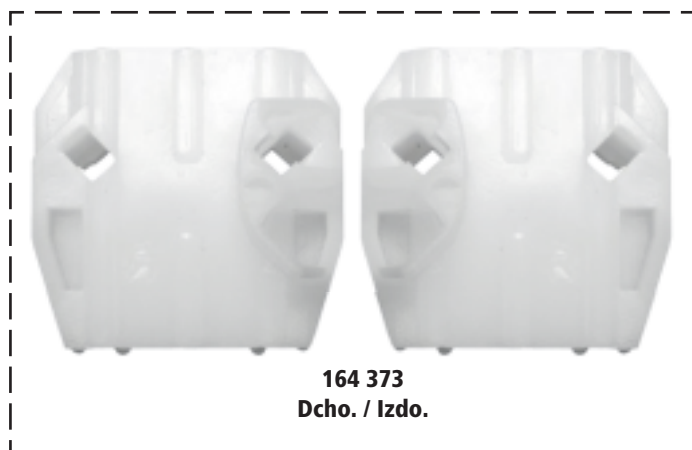

164 373
Dcho. / Izdo.



162 841



162 818



163 176



163 067



163 546 *- Dcho
163 547 *- Izdo



163 992 *- Dcho
163 993 *- Izdo

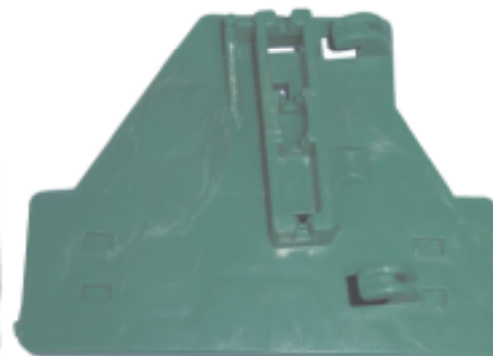

163 990 *- Dcho
163 991 *- Izdo

* (imagen 1/2 tamaño real)



V.A.G. (AUDI / SEAT / SKODA / VW)

Levas Cerradura Puerta / Door Locking



Familia 0300



181 426



181 442



181 427



181 429



181 441



181 440



181 428



* (imagen NO a tamaño real)

181 591 - kit leva largo 42,5 mm

181 595 - kit leva largo 44,0 mm

181 592 - kit leva largo 47,0 mm

181 593 - kit leva largo 57,5 mm

181 594 - kit leva largo 67,6 mm



V.A.G. (AUDI / SEAT / SKODA / VW)

Moldura puerta / Bodyside clips



Familia 0300



162 500



163 917



163 929



162 787



164 069



164 027



163 955



163 956



162 501



162 502



163 707



162 785



163 147



163 148



162 677



164 081



164 082



162 786



163 184*



163 185*



163 186*

* (imagen 1/2 tamaño real)



164 071



V.A.G. (AUDI / SEAT / SKODA / VW)

Moldura puerta / Bodyside clips



Familia 0300



162 788



162 789



162 790



162 791



162 301



162 302



162 303



163 103



163 395



164 023



162 837



163 394



163 884



162 792



162 793



162 794



162 796



164 269



164 270



164 271



V.A.G. (AUDI / SEAT / SKODA / VW)

Panel Puerta - Tapizados Interiores Door Panel - Interior Trim



Familia 0300



162 230



162 847



163 105



163 072



163 152



163 154



163 877



162 503



162 235



163 106



164 029



163 082



163 740



163 755



163 134



163 213



163 954



162 659



162 421



163 115



163 545



164 146



163 104



163 073



163 108



163 648



163 151



V.A.G. (AUDI / SEAT / SKODA / VW)

Panel Puerta - Tapizados Interiores Door Panel - Interior Trim



Familia 0300



163 468



163 469



162 946



163 089



164 145



163 387



163 117



163 212



163 470



163 541



164 265



162 670



162 671



164 266



164 247



164 246



162 769



162 300



162 784



163 244



163 245



V.A.G. (AUDI / SEAT / SKODA / VW)

Tapizados Interiores / Interior Trim



Familia 0300



162 674



162 297



163 209



162 767



163 777



162 877



162 257



163 542



163 230



162 778



162 929



163 188



162 761



163 183



V.A.G. (AUDI / SEAT / SKODA / VW)

Tapizados Interiores / Interior Trim

Familia 0300



162 779



162 884



163 177



163 207



163 116



163 204



163 205



162 772



162 773



163 974

Pasoruada - Botones / Wheel Arch - Buttons

Familia 0300



163 893



164 144



164 143



Ø 5,5

163 760



Ø 5,6

164 169



Ø 6

162 704



Ø 6,5

163 129



Ø 7,5

164 017



Ø 8

162 780



Ø 8

162 782



Ø 10

162 781

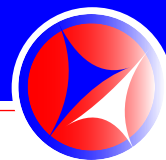

V.A.G. (AUDI / SEAT / SKODA / VW)

Tacos Plástico / Plastic Plugs



Familia 0300

6 x 6
Tornillo Ø 3



162 326

Ø 6
Tornillo Ø 4,2



162 783

6 x 6,5
Tornillo Ø 2,5



162 842

7 x 7
Tornillo Ø 3,5



162 817

7 x 7
Tornillo Ø 3,5



163 181

7 x 7
Tornillo Ø 3,5



162 776

7 x 7
Tornillo Ø 4



162 331

7 x 7
Tornillo Ø 4



162 775

7 x 7
Tornillo Ø 4,2



162 562

7 x 7
Tornillo Ø 4,2



162 244

7 x 7
Tornillo Ø 4,8



162 835

7 x 14
Tornillo Ø 4,2



163 350

7 x 15
Tornillo Ø 4,2



162 888

7 x 7,5
Tornillo Ø 3,5



162 774

7,5 x 7,5
Tornillo Ø 4,2



162 885

7,5 x 7,5
Tornillo Ø 4,2 - 4,8



162 836

7,5 x 7,5
Tornillo Ø 4,8



163 388

7,5 x 8,3
Tornillo Ø 4,8



164 168



V.A.G. (AUDI / SEAT / SKODA / VW)

Tacos Plástico / Plastic Plugs



Familia 0300



163 051



162 833



162 930



162 716



163 178



163 211



163 038



163 975



163 393



163 107



162 429



162 921



162 924



162 922



162 923



164 304



162 948



V.A.G. (AUDI / SEAT / SKODA / VW)

Remaches Plástico / Plastic Rivets



Familia 0300

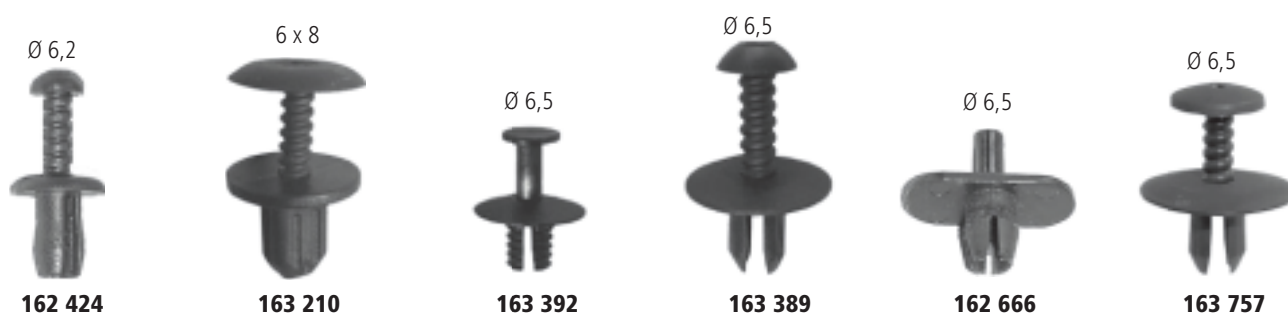
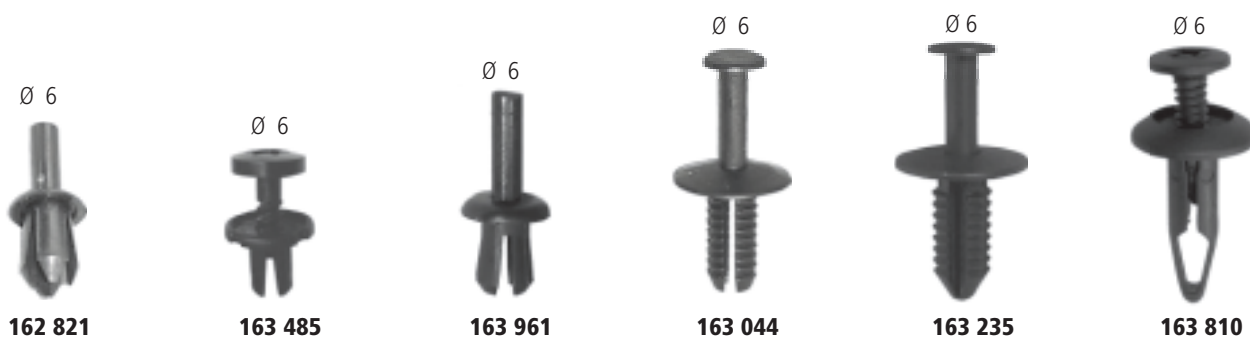



V.A.G. (AUDI / SEAT / SKODA / VW)

Remaches Plástico / Plastic Rivets



Familia 0300

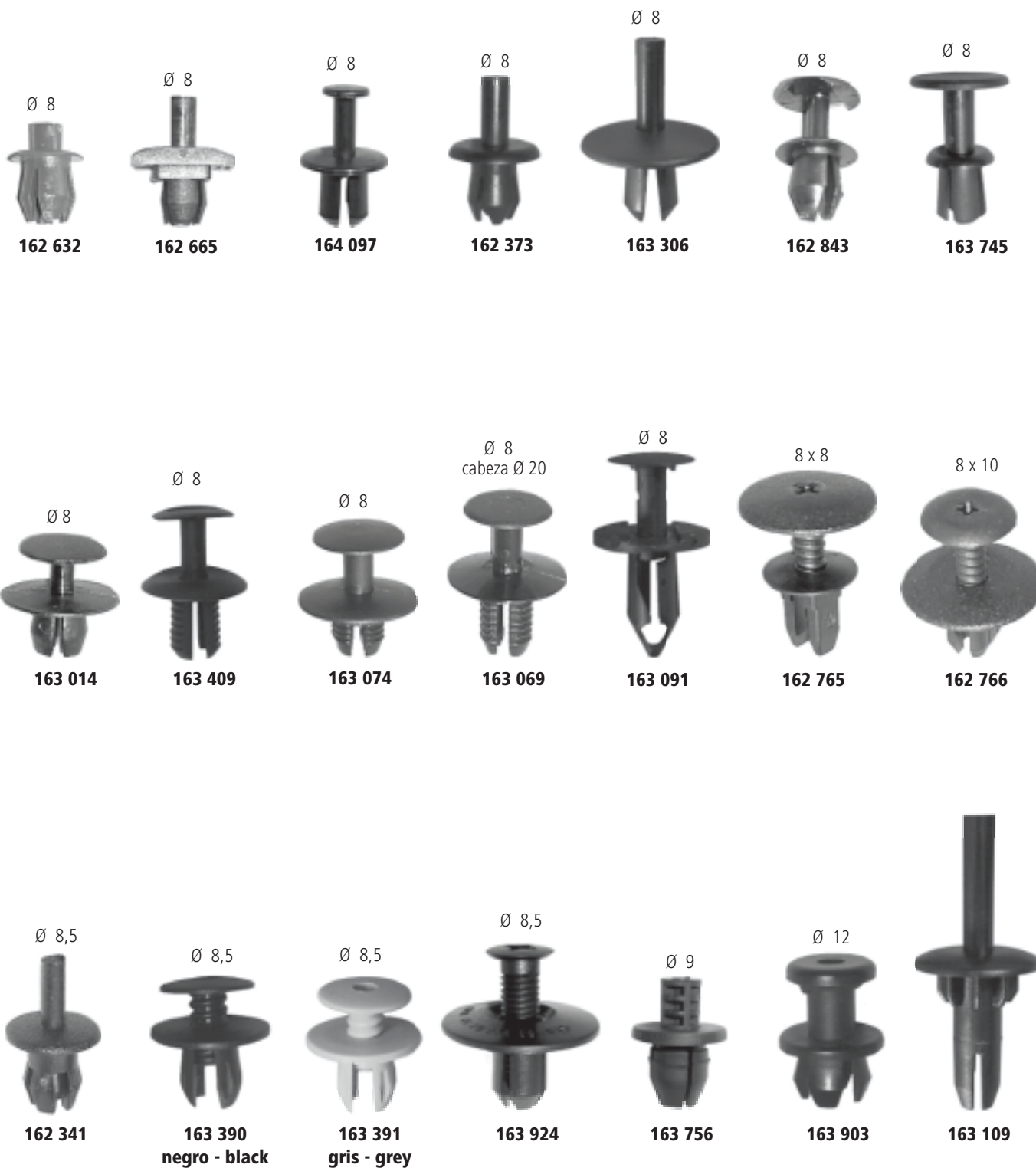



VOLVO

Bombas y Surtidor Lavaparabrisas / Washer Pumps or Jets



Familia 0300



190 359*



190 379*



190 380*

* (imagen 1/2 tamaño real)

Moldura Parabrisas / Windscreen Clips



Familia 0300



163 335



163 336



163 337



163 199



163 334



163 736



163 360



164 050



VOLVO

Moldura Parabrisas / Windscreen Clips

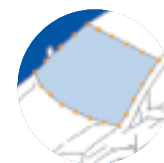

Familia 0300



163 643



163 646



164 311



163 647



163 644



164 021



164 172



164 283



163 761



163 762



163 763



163 958



163 764



163 838



163 839



VOLVO

Familia 0300



164 058



164 248



163 225



163 470



163 754



163 082



164 064



163 811



164 048



163 890



162 959



164 049



164 288



164 159



163 926



163 305



163 198



163 300



163 389



164 022



164 258



163 277



163 304



163 069



163 903



REMACHADORA

Remachadora para Remaches de Plástico

Descripción	Referencia	U/E
Remachadora	0840 540 001	1
Remache de Ø 6,3x25,2 mm	0840 586 325	50/100
Remache de Ø 5x17,2 mm	0840 585 172	50/100
Remache de Ø 6,6x17,3 mm	0840 586 617	50/100



Remaches de Plástico



Descripción	Ø	L	Ø _{ALA}	Referencia	U/E
Remache Plástico	5	17,2	12,5	0840 585 172	50/100
Remache Plástico	6,3	25,2	17	0840 586 325	50/100
Remache Plástico	6,6	17,3	17,5	0840 586 617	50/100



INDICE REFERENCIAS

FAM. 0300	Marca	Descripción
161 408	Fiat	Tope (goma) capó Uno
161 409	universal	
	Ford	Clip fijac. varios usos - varios -
161 410	universal	
161 411	universal	
	Fiat	Clip fijac. pasoruada Alfa Romeo 147, 159, 166, Fiat Bravo/a, Punto '99 y '03, Lancia Lybra, Kappa, Y
161 412	universal	
161 413	universal	
161 414	universal	
	Ford	Clip fijac. varios usos - varios -
	Mercedes	Clip fijac. varios usos Mercedes - varios -
161 415	universal	
161 418	universal	
	VAG	Clip fijac. pasoruada Golf y varios usos Ibiza, Toledo
161 420	BMW	Fijación revestimientos maletero serie 3 (E36 y E46), serie 5 (E34 / E39 y E61), fijac. tapizados interiores serie 7 (E65/66), X3
	Ford	Fijac. panel puerta Fiesta, Escort
	Mini	Fijac. tapizados interiores pilar D Mini Countryman R60
161 421	PSA	Fijac. panel puerta y revestimientos interiores P-205
161 422	Renault	Fijac. panel puerta y revestimientos interiores R-19, Clio I y II, Megane I y II, Kangoo, Laguna I y II, Modus, Safrane, Twingo, Master, Trafic
161 423	Renault	Fijac. molduras R-19, Clio I, Laguna, Safrane
161 424	Renault	Fijac. apoyabrazos y manecilla puerta R-5, R-9/11, R-18, R-19, Super-5, Express
161 425	Seat	Fijac. molduras laterales 600/850
161 426	universal	
161 427	universal	
	BMW	Clip fijac. parachoques tras. serie 5 (E60)
	Opel	Clip fijac. parachoques Corsa C, Meriva, fijac. panel toma aire Corsa B
	Renault	Clip fijac. protector guardabarros Clio I
	VAG	Clip fijac. varios usos - varios modelos -
161 428	PSA	Muelle fijac. manecilla elevalunas C-15
161 429	VAG	Tuerca fijac. altavoces - varios modelos -
161 430	universal	
	Seat	Tornillo fijac. parachoques Panda (Ø 6 mm.)
161 431	universal	
	Seat	Tornillo fijac. placa matrícula 127
161 432	universal	
	Renault	Tornillo fijac. guardabarros - modelos antiguos -
161 437	universal	
	Renault	Clip fijac. varios usos R-9/11, Super-5, Express, Safrane, Master, Traffic



INDICE REFERENCIAS

FAM. 0300	Marca	Descripción
161 438	universal	
	Ford	Clip fijac. varios usos - varios -
	Renault	Clip (Ø 6) fijac. pasoruedas R-9/11, Clio, Super 5, Express, Laguna, Safrane, Espace, Master, Trafic
161 440	universal	
	Seat	Tornillo para resbalón 127
161 447	universal	
	Renault	Clip fijac. rejilla lateral R-5
161 448	Fiat	Fijac. manecilla elevalunas Fiat Punto '97
	Seat	Fijac. manecilla alzacristales 600, 124, 127
161 449	universal	
	Renault	Clip fijac. guardabarros Twingo, Megane, Safrane
161 450	universal	
	Renault	Tornillo (en jaula móvil) fijac. parachoques Clio
161 453	universal	
	Fiat	Tornillo fijac. revestimiento pasoruada Bravo/a, Marea, Punto y fijac. tapizados interiores Bravo/a, Ducato '94, Grande Punto '05
161 454	universal	
	Fiat	Tornillo fijac. panel puerta y revestimientos Alfa Romeo 147, Fiat Dobló, Multipla, Punto '99 y '03, Seicento, Lancia Y, Ypsilon
161 455	universal	
	Fiat	Tornillo fijación travesía delantera Fiat Tipo, Tempra, Marea, fijac. guardabarros Bravo/a, Dedra, fijac. parachoques Alfa Romeo 33
161 456	universal	
	Fiat	Tornillo fijac. guardabarros Tipo, Tempra, Marea, Bravo/a, Cinquecento, Nuevo Delta, Dedra
161 457	universal	
	Fiat	Tornillo en jaula fijac. guardabarros Uno, Bravo/a, Marea
161 458	universal	
	Fiat	Tornillo fijac. parachoques del. Bravo/a, Marea (monta con 162.893)
161 459	Fiat	Tuerca fij. revestimientos interiores Alfa Romeo 147, 159, GT, Fiat Bravo/a, Marea, Punto '99 y '03, Stilo, Lancia Dedra y Nuevo Delta
	VAG	Tuerca fijac. moldura cristal puerta Audi A3, A4, Skoda Superb '02, VW Caddy '04, Golf V, Lupo, Passat '00, Polo '01, Touran
161 460	VAG	Tuerca fijac. guardabarros VW Golf, Polo '95 (monta con 162.556)
161 461	Ford	Fijac. protectores cárter y protectores térmicos Escort, Fiesta, Focus, Mondeo, Puma, Sierra, Transit, Transit Connect
	VAG	Fijac. protectores cárter, protectores térmicos - varios modelos -
161 462	Ford	Fijac. protectores cárter y protectores térmicos -varios modelos -
161 464	universal	
	Fiat	Clip fijac. montante Alfa Romeo 146, 155, 166, Fiat Bravo/a, Dobló, Ducato, Marea, Palio, Stilo, Tipo, Lancia Lybra, Y
161 465	universal	
	Ford	Clip fijac. frontal Fiesta, Escort
	Opel	Clip fijac. frontal Corsa, Kadett, Astra
	VAG	Clip fijac. frontal Golf III



INDICE REFERENCIAS

FAM. 0300	Marca	Descripción
161 467	universal	
	Renault	Tuerca enjaulada especial Renault R-19 y otros modelos antiguos (Ø 6)
161 468	universal	
161 469	universal	
161 470	PSA	Fijac. junta cristal Visa, C-15
161 471	PSA	Fijac. junta cristal P-205, P-309
161 472	universal	
161 473	universal	
	BMW	Tornillo Ø 4,8 x 15 (aro Ø 15), varios usos
	Ford	Tornillo Ø 4,8 x 15 (aro Ø 15), varios usos
	Mercedes	Tornillo Ø 4,8 x 15 (aro Ø 15), varios usos
	Opel	Tornillo Ø 4,8 x 15 (aro Ø 15), varios usos
	PSA	Tornillo Ø 4,8 x 18 (aro Ø 15), varios usos
	VAG	Tornillo Ø 4,8 x 15 (aro Ø 15), varios usos
161 474	universal	
	BMW	Tornillo Ø 4,8 x 18 (aro Ø 15), varios usos
	Ford	Tornillo Ø 4,8 x 18 (aro Ø 15), varios usos
	Mercedes	Tornillo Ø 4,8 x 18 (aro Ø 15), varios usos
	Opel	Tornillo Ø 4,8 x 18 (aro Ø 15), varios usos
	PSA	Tornillo Ø 4,8 x 18 (aro Ø 15), varios usos
	VAG	Tornillo Ø 4,8 x 18 (aro Ø 15), varios usos
161 475	universal	
	Fiat	Tornillo fijación guardabarros Alfa Romeo 147
161 476	universal	
	Fiat	Tornillo fijac. bisagra puertas A. Romeo, Fiat, Lancia - varios modelos -
161 477	universal	
	VAG	Tornillo Ø 4,8 x 15, fijac. pasoruada VW Golf III, Golf IV, Passat
161 478	Renault	Fijac. juntas estanqueidad puerta Megane, Scenic
161 479	Ford	Fijac. guarnecidos puerta (junta cristal) -varios modelos -
161 482	VAG	Fijac. revestimientos portón trasero Audi A2, A3, Seat Ibiza, Skoda Fabia, VW Golf IV, Polo '02->
161 483	universal	
161 484	universal	
	VAG	Clip fijac. tapizados portón trasero Polo 2002, fijac. parrilla radiador Transporter IV, fijac. otros usos - varios modelos -
161 485	Fiat	Fijac. moldura pasoruada Bravo '07, Dobló, Palio, Siena, Stilo, Strada
161 486	universal	
	PSA	Tornillo fij. parachoques Berlingo, C4, C5, C8, Jumpy, P-1007, P-206, P-307, P-307, P-807, Expert, Partner, fijac. aletas C4 '10, C5, P-407, P-3008, P-5008, fijac. faro Berlingo, Partner
	VAG	Tornillo Ø 6 x 19, fijac. parachoques trasero VW Golf IV
161 487	universal	
	Mercedes	Clip fijac. varios usos Mercedes - varios modelos -



INDICE REFERENCIAS

FAM. 0300	Marca	Descripción
161 488	universal	
	Fiat	Clip fijac. panel puerta Fiat Stilo, Lancia Y, fijac. parachoques Barchetta, Palio, fijac. tapizados Fiat Dobló, Multipla y fijac. faros antiniebla Alfa Romeo 156, 159
161 489	universal	
	VAG	Clip fijac. varios usos
161 490	universal	
	BMW	Clip fijac. varios usos BMW - varios modelos -
	Ford	Clip fijac. varios usos - varios -
161 491	universal	
	VAG	Clip fijac. varios usos
161 492	universal	
	Ford	Clip fijac. varios usos - varios -
	Mercedes	Clip fijac. varios usos Mercedes - varios modelos -
161 493	universal	
	BMW	Clip fijac. varios usos BMW - varios -
	Ford	Clip fijac. varios usos - varios -
	Mercedes	Clip fijac. varios usos Mercedes - varios modelos -
161 495	universal	
	BMW	Clip fijac. varios usos BMW - varios modelos -
161 496	universal	
	PSA	Clip fijac. varios usos - varios modelos -
	Renault	Clip fijac. varios usos - varios modelos -
161 497	universal	
	VAG	Clip fijac. guardabarros delantero VW Golf, Polo'95
161 498	universal	
	BMW	Clip fijac. guardabarros BMW - varios modelos -
	Mercedes	Clip fijac. varios usos Mercedes - varios modelos -
	VAG	Clip fijac. varios usos VAG - varios modelos -
161 499	universal	
	Ford	Clip fijac. talonera puerta P-306, P-605
	PSA	Clip fijac. talonera puerta P-306, P-605
	Renault	Clip fijac. talonera puerta Clio, Espace, Trafic
161 555	universal	
161 650	universal	
	VAG	Remache Ø 3,2 x 6, varios usos
161 651	universal	
161 652	universal	
	Renault	Remache 4 x 10, varios usos R-19, R-21, Espace, Traffic
161 653	universal	
	VAG	Remache Ø 4 x 14, paso rueda y spoiler VW Golf
161 654	universal	
161 655	universal	
161 656	universal	



INDICE REFERENCIAS

FAM. 0300	Marca	Descripción
161 701	universal	
	Fiat	Clip fijac. faro antiniebla Panda 2003, panel puerta Lancia Lybra
161 702	universal	
	BMW	Clip fijac. guardabarros s.3 (E30), tapizados maletero s.5 (E34) y tapizados interiores s.5 (E39)
161 703	Mercedes	Clip fijac. varios usos Mercedes - varios modelos -
	universal	
	Ford	Clip fijac. varios usos - varios -
	Mercedes	Clip fijac. varios usos Mercedes - varios modelos -
161 704	Renault	Clip fijac. varios usos Renault - varios modelos -
	universal	
	BMW	Clip fijac. varios usos BMW - varios modelos -
	Ford	Clip fijac. varios usos - varios -
161 705	Opel	Clip fijac. varios usos Opel - varios modelos -
	universal	
	Fiat	Tornillo fijac. parachoques Bravo/a, Punto, Tipo/Tempra
161 706	Renault	Tornillo fijac. parachoques Twingo
	universal	
161 707	Fiat	Tornillo fijac. bisagra puerta Alfa Romeo 147, 155, 156, Fiat Bravo/a, Multipla, Punto '99 y '03, Tipo, Tempra, Lancia Delta, Lybra, Kappa, Y, Ypsilon
	Renault	Tornillo Ø 6 x 20, fijac. parachoques - varios modelos -
161 708	VAG	Tornillo fijac. protector motor/cárter - varios modelos -
161 709	VAG	Tornillo fijac. protector motor/cárter - varios modelos -
161 711	VAG	Tuerca fijac. protector motor/cárter Audi A4, fijac. parachoques Audi A4, A6
161 712	VAG	Tornillo fijac. protector motor/cárter Audi 80, A8, Cabriolet
161 713	VAG	Tornillo fijac. parachoques Audi A4, A6
161 714	BMW	Tuerca fijación pasoruada y tapa motor s.5 (E39), s.7 (E38), Z8 (E52)
161 715	BMW	Tornillo fijación insonorizantes motor serie 3 (E46)
	Mini	Tornillo fijación protector compartimiento motor R50, R52, R53
161 716	BMW	Tornillo fijación tapa motor serie 5 (E39), serie 7 (E38), Z8 (E52)
161 717	BMW	Tornillo fijación tapa motor serie 5 (E39), serie 7 (E38)
161 718	PSA	Tornillo fijación protector motor/cárter y fijac. aletas y parachoques Berlingo, C2, C3, C4, C5, C8, Jumpy, P-206, P-207, P-807, P-1007, Expert, Partner
161 719	PSA	Fijac. protector motor/cárter y fijac. aletas y parachoques Berlingo, C2, C3, C4, C5, C8, Jumpy, P-206, P-207, P-406, P-407, P-508, P-807, Expert, Partner
161 720	PSA	Fijac. logotipos y seguro fijac. bisagra puertas Berlingo '09, C2, C3, C4, C5, Jumpy III, P-307, P-308, P-407, Partner '09, Expert III
161 721	universal	
	Opel	Tornillo Ø 6 x 20, varios usos
	PSA	Tornillo Ø 6 x 20, fijac. parachoques delantero P-307 Restyling, y trasero P-407 y varios usos C1, C2, C3, C4, C5, Berlingo, DS3, Jumpy, Nemo, Xsara, Xsara Picasso, P-107, P-207, P-308, P-406, P-508, P-807, P-1007, P-3008, P-5008, Bipper, Expert, Partner
	Renault	Tornillo Ø 6 x 20, varios usos



INDICE REFERENCIAS

FAM. 0300	Marca	Descripción
161 723	universal	
	Fiat	Tornillo Ø 6 x 23 con aro móvil Ø 18, varios usos
	PSA	Tornillo Ø 6 x 23 (aro Ø 18), fijac. aletas, parachoques y otros usos Berlingo, C2, C3, C4, C5, Xsara Picasso, P-106, P-106, P-306, P-308, P-406, P-407, P-607, P-1007, Partner
161 724	universal	
	Dacia	Tornillo Ø 6 x 20 (aro Ø 22), fijac. parachoques delantero Logan
	Renault	Tornillo Ø 6 x 20 (aro Ø 22), fijac. aletas y parachoques Clio IV y otros modelos
161 725	Renault	Fijac. varios usos Clio III, Megane CC, Modus, Scenic II
161 726	Renault	Fijac. aletas Scenic II
161 727	universal	
	Dacia	Tornillo Ø 6 x 20 (aro Ø 18), fijac. aleta delantera Logan y Sandero
	Opel	Tornillo Ø 6 x 20 (aro Ø 18), varios usos
	Renault	Tornillo Ø 6 x 20 (aro Ø 18), fijac. parachoques delantero Laguna III y varios usos
161 728	universal	
	Renault	Tornillo Ø 7 x 16, fijac. cerraduras - varios modelos -
161 729	universal	
	Renault	Tornillo Ø 8 x 26,5, fijac. cerraduras Espace III, Kangoo, Laguna, Master, Safrane
161 730	universal	
	PSA	Tornillo Ø 6 x 18 (aro Ø 18), fijac. aletas, parachoques y otros usos Berlingo, C2, C3, C4, C5, Jumper, Jumpy, Xsara Picasso, P-106, P-106, P-306, P-308, P-406, P-407, P-607, P-1007, Boxer, Expert, Partner
161 731	universal	
	Dacia	Tornillo Ø 6 x 28 (aro Ø 24), fijac. parachoques trasero Sandero
	Renault	Tornillo Ø 6 x 28 (aro Ø 24) fijac. parachoques trasero - varios modelos -, fijac. rejilla calandra Clio IV, Laguna III, Latitude
161 732	universal	
	Renault	Tornillo Ø 6 x 17,5, fijac. cerraduras Kangoo II, 4x4
161 733	universal	
	Renault	Tornillo Ø 6 x 13, fijac. cerraduras Espace III, Express, Kangoo, Laguna, Master, Megane, Scenic
161 735	VAG	Fijac. revestimientos puerta (apoyabrazos) Seat Altea, Ibiza '02, León '99 y '05, Toledo '99 y '05, VW Golf IV y V, Passat '97, Polo '02
161 736	universal	
	VAG	Clip fijac. pasoruada Seat León '99, Toledo '99, fijac. parachoques Seat Toledo '91->'99, fijac. otros usos VAG
161 737	universal	
	VAG	Clip fijac. varios usos Audi 80, A3, A6, Seat Alhambra, Arosa, Córdoba, Ibiza, Inca, León, Toledo, Skoda Fabia, Octavia, Superb, VW Caddy, Golf, LT, Lupo, Passat, Polo, Sharan, Transporter
161 738	universal	
	VAG	Clip fijac. pasoruada Audi A2, fijac. otros usos Audi A3, A4, A6, VW LT, Passat
161 739	universal	
	universal	
	BMW	Tornillo fijación varios usos BMW - varios modelos -
161 740	universal	
	Ford	Clip (especial «ovalado») fijac. varios usos - varios -



INDICE REFERENCIAS

FAM. 0300	Marca	Descripción
161 741	universal	
	VAG	Clip fijac. parachoques Seat Altea, Ibiza/Córdoba '99 y '02->, León '05->, VW Touareg, fijac. pasoruada Audi A3 '03, Seat Altea, Leon '05, fijac. moldura estribera puerta Seat Altea, fijac. bajos carrocería Audi Q5, Seat Altea, Leon '05
161 742	universal	
	Ford	Tornillo Ø 5,5 x 19 (aro Ø 22), sujeción guardabarros -varios modelos -
	Mercedes	Tornillo Ø 5,5 x 19 (aro Ø 22), suj. guardabarros
	Opel	Tornillo Ø 5,5 x 19 (aro Ø 22), sujeción guardabarros
	VAG	Tornillo Ø 5,5 x 19 (aro Ø 22), sujeción guardabarros
161 743	universal	
	BMW	Tornillo Ø 6,3 x 19 (aro Ø 22), fijac. guardabarros
	Ford	Tornillo Ø 6,3 x 19 (aro Ø 22), sujeción guardabarros -varios modelos -
	Mercedes	Tornillo Ø 6,3 x 19 (aro Ø 22), suj. guardabarros
	Opel	Tornillo Ø 6,3 x 19 (aro Ø 22), sujeción guardabarros
	VAG	Tornillo Ø 6,3 x 19 (aro Ø 22), sujeción guardabarros
161 744	universal	
	VAG	Clip fijac. varios usos - varios modelos -
161 745	universal	
	Opel	Clip fijac. placa matrícula Opel Agila, Ascosa, Astra F, Calibra, Corsa A, B y C, Kadett, Signum, Vectra A, B y C
161 746	universal	
	Mercedes	Clip fijac. rejillas frontales W124, W126 y varios
161 747	universal	
	Ford	Clip fijac. revestimientos puerta - varios modelos -
161 748	Mercedes	Clip fijac. revestimientos puerta - varios modelos -
	universal	
161 749	Mercedes	Clip fijac. protector cárter/motor - varios modelos -
	universal	
161 750	Dacia	Tornillo Ø 5 x 22 (aro Ø 16), fijac. parachoques y moldura puerta Logan, Sandero, Lodgy y Dokker, fijac. pasoruada Duster
	Opel	Tornillo Ø 5 x 22 (aro Ø 16), varios usos
	Renault	Tornillo Ø 5 x 22 (aro Ø 16), fijac. pasoruada y parachoques Clio III y IV, Kangoo II, Laguna III, Megane III, Twingo II, fij. rejilla parabrisas Scenic III, fij. emblema delantero Clio IV, fij. moldura puerta, aleta trasera y rejilla calandra Captur
161 751	Fiat	Fijac. parachoques Alfa Romeo 147, 156, 159, Fiat Siena, Strada, y fijac. tapizados interiores Fiat Dobló, fijac. rejilla radiador Fiat Cromar'05 y Palio
161 752	universal	
161 752	Fiat	Tornillo fijac. parachoques Alfa Romeo 145, 146, 147, 156, 159, 166, Brera, Fiat Dobló, Ducato, Grande Punto, Marea, Multipla, Palio, Panda '03, Punto '99 y '03, Seicento, Siena, Strada, Lancia Lybra, Thesis, Y, Ypsilon
161 754	universal	
	Fiat	Tornillo fijac. cerraduras puerta Alfa Romeo 145, 146, 147, Fiat Dobló, Multipla, Punto '99 y '03, Seicento, Lancia Y
161 755	VAG	Fijac. aleta delantera VW Golf IV



INDICE REFERENCIAS

FAM. 0300	Marca	Descripción
161 756	universal	
	Opel	Clip fijac. aletas Astra F, G y H, Corsa B y D '07->, Vectra B y C, Signum, Zafira A y B
161 757	universal	
	Mercedes	Clip fijac. tapa altavoces Mercedes - varios modelos -
161 758	universal	
	Fiat	Tornillo fijac. manecilla puerta y portón trasero Alfa Romeo 147, Fiat Bravo/a, Dobló, Marea
161 759	Fiat	Clip fijac. parachoques Alfa Romeo 147, 156, GT
161 760	universal	
	Fiat	Tornillo Ø 4,5 x 19 (aro Ø 12), fijac. plásticas varias
	PSA	Tornillo Ø 4,5 x 19 (aro Ø 12), fijac. plásticas varios usos
161 761	universal	
	PSA	Tornillo Ø 4,5 x 19 (aro Ø 16), fijac. parachoque, aletas y otros usos C2, C3, C4, C5, C8, Berlingo, Jumpy, Xantia, Xsara Picasso, P-206, P-207, P-307, P-308, P-407, P-508, P-3008, P-5008, Expert, Partner
161 762	universal	
	Renault	Tornillo Ø 5 x 17 (aro Ø 15), fijac. plásticas varias
161 763	universal	
	Renault	Tornillo Ø 6 x 26 (aro Ø 17), fijac. plásticas varias
161 764	universal	
	VAG	Tornillo Ø 5 x 16, fijac. pasoruada y parachoques VW Caddy '04, Golf V, Phaeton, Touran, fijac. moldura puerta VW Passat '97, fijac. parachoques Seat Cordoba '03, VW Polo '02, y otros usos Audi A4, A6, A8, TT, VW New Beetle
161 765	VAG	Fijac. moldura portón maletero VW Bora, Golf IV, V y VI, Passat '05, Tiguan, Touran
161 766	VAG	Fijac. moldura estribera, panel puerta y otros usos interiores Audi A3 '04->, A4 '01->, A5, A6 '05->, Q5, Q7, TT, Seat Alhambra '03->, Altea, Ibiza / Cordoba '02, León '05, Toledo '05, Skoda Fabia, Octavia '04, Superb '08, VW Golf IV '03->, V y VI, EOS, Jetta, New Beetle Cabrio, Polo '02->, Sharan '01->, Tiguan, Transporter '03->
161 767	PSA	Fijac. protección bajos carrocería C5 '04 y '08->, C6, P-407, fijac. absorbedor parachoques delantero P-207
161 768	VAG	Fijac. revestimientos maletero VW Bora, Golf IV, Touran
161 769	universal	
	Renault	Tornillo Ø 6 x 17, fijac. varios usos
161 770	VAG	Fijac. revestimientos puerta Seat Ibiza '09, León '05
161 771	universal	
	Ford	Clip fijac. aleta delantera Ford C-Max, Focus '05->, Mondeo '96->'07
161 772	BMW	Tuerca fijación insonorizante motor serie 3 (E46), serie 5 (E60/E60N/E61/E61N), Z4 (E86)
	Mini	Tuerca fijación insonorizante motor R50, R53
	VAG	Tuerca fijac. protector motor/cárter Audi A4 22308->, A5, Q5
161 773	BMW	Fijación parachoques trasero serie 1 (E82/E88), parachoques delantero Z4 (E85/E86)
161 774	BMW	Fijación varios usos BMW - varios modelos -
	Mini	Fijación varios usos R50, R52, R53, R55, R56, R57, R60
161 775	BMW	Fijación marco puerta trasera serie 1 (E87/E87N), y X1 (E84)
161 776	BMW	Fijación cubierta superior parabrisas X5 (E53) '00->'07
161 777	universal	
	Renault	Tornillo Ø 4,5 x 16, fijac. varios usos
161 778	universal	
	Renault	Tornillo Ø 4,5 x 13, fijac. varios usos



INDICE REFERENCIAS

FAM. 0300	Marca	Descripción
161 779	Dacia	Fijac. panel puerta Logan, Sandero
	Renault	Fijac. varios usos R-19, R-21, R-25, Safrane
161 780	VAG	Tornillo fijac. protector motor/cárter Audi A4 '08->, A5, Q5
161 781	Opel	Clip fijac. aletas delanteras Astra H, Corsa D '07->
161 782	VAG	Fijac. protectores motor/cárter - varios modelos -
161 783	BMW	Fijación insonorizante motor serie 1 (F20/21), serie 3 (F30/31), X3 '09-> (F25)
	Mini	Fijación revestimientos puertas R55, R56, R57, R58 y R59
161 784	BMW	Fij. pasoruada y bajos serie 3 (E46), fij. parachoques trasero serie 1 (E81/87), serie 3 (E92/93), X1
161 785	BMW	Fijación embellecedor parachoques trasero serie 6 (F12), X6 (apertura estrecha)
	Ford	Fijación varios usos -varios modelos-
161 786	Mini	Fijación embellecedor parachoques trasero Mini Countryman R60
	BMW	Fijación embellecedor parachoques trasero X3 (F25) (apertura ancha)
161 787	universal	
	BMW	Clip fijac. parachoques delantero y trasero X3 '03->'10 (E83/E83N)
161 788	universal	
	BMW	Clip fijac. varios usos -varios vodelos-
161 789	universal	
	VAG	Tornillo Ø 5 x 16, fijac. pasoruada Audi A3 '13, Q3, Seat Alhambra '11, Leon '13, Mii, fijac. bajos carrocería Seat Altea, Exeo, Leon '05, Skoda Octavia '05, fijac. parachoques Audi A1, A3 '03, A4 '13, A5, A6 '13, A7, Q5, Q7, Seat Mii, Leon '05, Toledo '05, Skoda Fabia '07, Yeti, VW Caddy '11, Golf VI y VII, Polo '09, Scirocco, Tiguan, Touran, UP
161 790	Ford	Fijación pasoruada C-Max '03, Fiesta '02 y '08, Focus '04
161 791	VAG	Fijac. talonera puerta Audi A1, A3 '03, Seat Altea, Ibiza '02, Cordoba '03, Leon, Toledo, VW Golf V, otros usos A2, A4, A6, A7, Alhambra, Exeo, Mii, Passat, Sharan, Tiguan, UP
161 792	VAG	Tuerca fijac. protector motor/cárter Audi A6 '05->
161 793	BMW	Tornillo fijación cubierta culata serie 1 (E87), serie 3 (E90/91), serie 5 (E60/61), serie 7 (E65/66)
161 794	Mini	Tuerca fijación parachoques R50, R52, R53, R56, R57, R58 y R59
161 797	Fiat	Fijac. parachoque delantero Ducato '06->
	PSA	Fijac. parachoque delantero Jumper '06, Boxer '06
161 798	universal	
	VAG	Tornillo Ø 6 x 12 (aro Ø 18), fijac. aleta delantera Audi A6 '00, VW Golf V, Passat '11, Polo '10, UP
161 799	universal	
	VAG	Tornillo Ø 6,3 x 18 (aro Ø 18), fijac. aletas Audi A3 '97->'03, VW Transporter '03, Amarok '10, fijac. faro Seat Ibiza '08->, Leon '13->
161 800	universal	
	Ford	Clip fijac. pasoruada Ford C-Max, Focus '05->, Galaxy, Mondeo '00->, S-Max '06
161 801	universal	
	Ford	Clip fijac. parachoque y rejilla calandra C-Max '03, Focus '04,
161 803	universal	
	PSA	Tornillo Ø 4,5 x 20, fijac. plásticas varios usos
161 804	universal	
	PSA	Tornillo Ø 4,5 x 25, fijac. plásticas varios usos
	PSA	Tornillo Ø 4,5 x 30, fijac. plásticas varios usos



INDICE REFERENCIAS

FAM. 0300	Marca	Descripción
161 805	universal	
	universal	
161 806	BMW	Clip fijac. varios usos BMW - varios modelos -
	Mini	Clip fijación varios usos Countryman R60, Paceman R61
161 807	Renault	Fijac. parachoque delantero Captur
161 808	VAG	Fijac. insonorizante motor Audi A2, A3 '97->'03, Seat Arosa, Leon '99->'05, Ibiza/Cordoba '99->'08, Toledo '99, VW Golf IV, Lupo, Polo '02->'09
161 809	Ford	Fijación deflector aire Focus '04
161 810	Ford	Fijación deflector aire Mondeo '00->'07
161 811	Ford	Fijación parachoque trasero Focus '04->
	Ford	Fijac. rejilla parabrisas "torpedo" C-Max '03, Fiesta '08, Focus '04, Mondeo '07, S-Max/Galaxy '06
	universal	
161 812	Mercedes	Clip fijac. protectos cárter/motor Mercedes clase A (W169), clase B (W245), clase C (W202, 203 y 204), clase E (W210 y 211) y ML
	universal	
161 813	Mercedes	Clip fijac. parachoque clase A (W169), clase B (W245) y GL, fij. tapizados interiores clase E (W211)
	universal	
161 815	Opel	Clip fijac. parachoque Astra G, Omega B, Vectra B, Zafira A, fij. tapizados interiores Astra G y H, Vectra C, Zafira A y B
161 816	Opel	Clip fijac. tapizados interiores Astra G y H, Corsa B y C, Meriva A, Signum, Vectra B y C, Zafira A y B
161 817	VAG	Fijac. tapa motor Audi A3 '97->'03, A4 ->'08, A6 ->'05, Seat Arosa, Exeo, Ibiza/Cordoba '99->'02, Toledo/Leon '99, Octavia, VW Golf IV, Passat ->'05, fij. parachoques Audi Q7, Fabia '07, Touareg
161 818	VAG	Fijac. parachoques Audi A1, A3 '08, Q7, Seat Exeo, VW Golf V y VI, Passat '05->'11, Polo '02->'09, Tiguan, Touran
161 819	VAG	Fij. tapizados interiores Audi A4 '01->'08, A5, A7, Q3, Seat Altea, Exeo, Ibiza '08->, Leon '13->, VW Passat '05 y '11->
	universal	
161 820	Toyota	Tornillo Ø 6,3 x 24 (aro Ø 16), parachoques Auris '07, Avensis '03, Camry '06, Celica, Corolla ->'06
161 821	VAG	Fijac. protectores motor/cárter - varios modelos -
161 822	Ford	Fijación paneles y revestimientos interiores C-Max '03, Focus '04, Kuga '08
161 823	Ford	Fijación revestimientos interiores Focus '04, Mondeo '00->'07
161 824	Ford	Fijación panel puerta Fiesta '08, Galaxy '06, Kuga, Mondeo '07, S-Max '06
161 825	Mercedes	Clip fijac. tapizados interiores Vito (W638)
161 826	Mercedes	Clip fijac. tapizados interiores Vito (W639)
	universal	
161 827	PSA	Tornillo Ø 6,3 x 20 (aro Ø 20), parachoques y bajos carrocería C1, P-107
	Toyota	Tornillo Ø 6,3 x 20 (aro Ø 20), parachoques y bajos carrocería Avensis '03, Aygo, Rav 4 '00->'05, Yaris '99 y '06->
161 828	Renault	Fijac. panel puerta Clio IV '12->
	universal	
161 829	Toyota	Tornillo Ø 6,3 x 16 (aro Ø 16), parachoques Auris '07, Camry '06, Land Cruiser '02
161 830	VAG	Fijac. tapizados interiores Audi A1, A2, A3, A4, A5, A6, Q3, Q5, Seat Alhambra '11, Altea, Ibiza '08->, Leon '05->, Mii, Toledo '05 y '13->, Skoda Citigo, Fabia '07->, Octavia '04->, Rapid, Superb, Yeti, VW Caddy '09->, Golf VII, Passat '05 y '11->, Polo '02 y '09->, Scirocco, Sharan '11, Touran, Up
	universal	
161 831	BMW	Tornillo Ø 5 x 25 fijac. placa matrícula BMW - varios modelos -



INDICE REFERENCIAS

FAM. 0300	Marca	Descripción
161 832	universal	
	BMW	Tornillo Ø 4,8 x 15 (aro Ø 15), fijac. aletas BMW -varios modelos-
	Mini	Tornillo Ø 4,8 x 15 (aro Ø 15), fijac. bajos carrocería R50, R52, R53, R56, R57, R58 y R59
161 835	universal	
	Toyota	Tornillo Ø 5 x 17 (aro Ø 16), parachoque Auris '07, Corolla '01->'06, fij. pasoruada Avensis '97->'03, fijac. faro Avensis '03->
161 836	VAG	Fijac. tapizados interiores maletero Seat Ibiza '02 y '08, León/Toledo '99->'05, Skoda Octavia '05->, Yeti, VW Golf IV, Passat '97, '05 y '11->, Polo '02->'09, Touran '03 y '10->, Touareg '03->'10
161 837	Renault	Fijac. moldura portón trasero Clio 4 '12->
161 838	VAG	Fijac. revestimientos maletero Skoda Octavia '97->'11, fijac. tapizados interiores VW Jetta '11->
161 839	VAG	Clip fij. pasoruada, parachoque, bajos carrocería y otros usos Audi A3 '03->, A6 '05->, A7, Q5, Q7, Skoda Fabia, Rapid, Roomster, Seat Alhambra, Exeo, Toledo '13, VW Sharan, Touareg
161 840	universal	
	VAG	Clip fijac. parachoque Audi Q3, Q5, Q7, fijac. bajos carrocería Audi A4 '08->, A5, A6 '11->, A7, Seat Ibiza '08->, fijac. pasoruada Skoda Octavia '97->'11,
162 200	universal	
162 201	universal	
162 202	universal	
162 211	universal	
162 212	universal	
162 221	universal	
	Opel	Fijac. rejilla calandra Zafira B '05, fijac tapizados interiores Astra F, Corsa A y B, Kadett, Omega B, Vectra A y C (Negro)
	PSA	Fijac. tapicería Berlingo, P-106, P-206, P-307, P-405, P-605, Partner, fijac. capó P-206, P-307 (Negro)
162 222	Renault	Fijac. panel y tapicería todos los modelos (Negro)
	universal	
	Opel	Botón fijac. panel y tapicería todos los modelos (Gris)
	PSA	Fijac. tapicería Berlingo, P-106, P-405, P-605, Partner (Gris)
162 227	Renault	Fijac. panel y tapicería todos los modelos (Gris)
	Fiat	Fijac. panel puerta Alfa Romeo - varios -, Fiat Dobló, Marea, Uno, Lancia Y-10
	162 228	Fiat
162 229	Fiat	Fijac. panel puerta Uno, Regata, Alfa 33
	PSA	Fijac. panel puerta y revestimientos interiores P-405
	Renault	Fijac. panel puerta y revestimientos interiores R-5, R-12, R-18
162 230	Ford	Fijac. panel puerta y revestimientos interiores Fiesta, Galaxi
	VAG	Fijac. revestimientos interiores Seat Alhambra, VW Sharan '96->'00
162 231	Ford	Fijac. panel puerta Fiesta y Sierra
162 232	Fiat	Fijac. panel puerta Y-10
162 234	Renault	Fijac. panel puerta y vano rueda Super-5, Express
162 235	BMW	Fijac. panel puerta BMW - varios modelos -
	Ford	Fijac. panel puerta - varios modelos -
	VAG	Fijac. panel puerta - varios modelos -



INDICE REFERENCIAS

FAM. 0300	Marca	Descripción
162 237	universal	
	PSA	Fijac. tapizados traseros, portón trasero P-307, P-308, P-406, P-3008, P-5008, fijac. frontal ordenador C4 '11->
162 238	universal	
	Fiat	Taco fijac. revestimientos interiores Cinquecento, Uno, Bravo/a, Marea, Croma, Tipo, Tempra, Regata, Ducato, Y-10, fijac. varios usos Alfa Romeo, Fiat Punto
	Ford	Taco fijac. - varios usos - Fiesta
	Mercedes	Fijac. molduras portón trasero Vito (W638)
	Renault	Taco fijac. revestimientos interiores R-9/11, R-19, R-21, R-25, Clio, Safrane, Espace, Master, Traffic, fijac. vano rueda Twingo, fijac. molduras Express
Seat	Tuerca rápida varios usos	
162 240	universal	
	Fiat	Taco fijac. rejilla Fiat Uno, Alfa 145/146, matrícula Fiat Dobló
	Seat	Tuerca rápida varios usos 131, Ritmo
162 241	universal	
	Seat	Fijac. faro delantero 127 y trasero Panda
162 242	universal	
	Fiat	Taco fijac. revestimientos interiores Fiat Punto, Croma
162 243	Seat	Fijac. varios usos 127, Panda
	universal	
162 244	Fiat	Taco fijac. revestim. interiores Fiat Ducato, Uno, Lancia Y-10, Y
	Seat	Fijac. varios usos 127, Panda
	universal	
162 245	Fiat	Taco fijac. - varios usos - Fiat Punto, Bravo/a, Marea, Tipo, Tempra, Ducato, Lancia Y-10, Alfa R.
	PSA	Fij. revestimientos interiores, parachoques y aletas AX, Berlingo, BX, C3, C4, C4 Picasso, C5, C-15, Jumpy I, II y III, Saxo, Xantia, XM, Xsara, ZX, P-206, P-207, P-306, P-307, P-308, P-407, P-508, P-3008, P-5008, Expert, Partner
	VAG	Fijac. parachoques y otros usos Seat Ibiza/Cordoba '97->'02, Inca, Toledo '92->'99, VW Caddy '96, Golf Cabriolet, Polo
162 247	universal	
	Fiat	Fijac. pilotos posteriores Fiat Tipo, Tempra (sin junta)
162 248	Fiat	Fijac. faro Fiat Regata
	Seat	Fijac. faro 127, 131, Ritmo
162 250	Fiat	Fijac. faro Fiat Regata, Lancia Y-10
	Seat	Fijac. faro 127, 131, Ritmo
162 251	Fiat	Fijac. faro Fiat Tipo, Tempra
162 252	Fiat	Fijac. faro Fiat Tipo
162 253	Fiat	Regulador faro Fiat Uno
162 254	Fiat	Regulador faro Fiat Uno
162 255	Fiat	Distanciador faro Fiat Uno
162 257	Ford	Fijac. rejilla frontal Fiesta
	VAG	Fijac. panel puerta Audi A8
162 258	universal	
	Fiat	Remache fijac. revestimientos interiores Alfa Romeo 145, 146, 155, Fiat Uno, Punto, Croma, Tipo, Tempra, Regata, Ducato, Lancia Dedra, Thema



INDICE REFERENCIAS

FAM. 0300	Marca	Descripción
		universal
162 259	Mercedes	Remache fijac. varios usos Mercedes
	Renault	Remache fijac. pasoruada R-4, R-5, R-9, R-11, Super-5, Express, Master, Traffic, Espace
162 260		universal
	Fiat	Remache fijac. moldura Alfa Romeo 33
162 261	Ford	Fijac. moldura cristal Fiesta
162 262	Ford	Fijac. vierteaguas Fiesta
162 263	Fiat	Fijac. moldura techo Fiat Cinquecento, Palio, Siena, Uno, Ducato, Fiorino, Lancia Thema
162 264	Fiat	Boca fijación siglas Fiat Cinquecento, Uno, Regata, Duna, Fiorino
162 266	Ford	Fijac. anagramas -varios modelos-
	Opel	Fijac. anagramas modelos
162 267	VAG	Fijac. anagramas de tipo de modelo, fijac. tapizados puerta Seat Ibiza/Cordoba, León, Toledo, Skoda Octavia, VW Golf, LT, Passat, Polo, Transporter
162 270	Fiat	Fijac. varilla capó Alfa R. 145/146, Fiat Bravo/a, Croma '05, Dobló, Ducato, Marea, Tipo, Tempra
162 272	Fiat	Fijac. varilla capó Fiat Cinquecento, Lancia Y-10, Alfa Romeo 33
162 273	Fiat	Fijac. varilla capó Fiat Uno, Regata
	Seat	Fijac. varilla capó Panda
162 281	Opel	Fijac. faro Frontera, Kadett, Omega, Senator
162 282	Ford	Base regulador faro Fiesta '89
162 292	VAG	Regulador faro VW Golf '90
162 293	VAG	Regulador faro VW Golf '90
162 294	VAG	Fijac. regulador faro VW Golf '90
162 295	VAG	Soporte parachoques delantero VW Golf '89
162 297	VAG	Fijac. revestimientos interiores VW Golf ->'92, Jetta, Passat ->'97
162 298	Ford	Regulador faro Derecho Fiesta '89
162 299	Ford	Regulador faro Izquierdo Fiesta '89
162 300	VAG	Fijac. panel puerta y revestimientos interiores VW Golf III (tipo largo)
162 301	VAG	Fijac. moldura lateral VW Golf III (extremo anterior/posterior)
162 302	VAG	Fijac. moldura lateral VW Golf III (central)
162 303	VAG	Fijac. moldura lateral VW Golf III (extremo posterior)
162 305	Fiat	Fijac. cristal lateral Croma, Thema
162 306	Renault	Fijac. cristal lateral R-19, Clio, Megane (Eurocode 7231LSCHFDS)
162 307	Seat	Fijac. cristal Panda
162 316	Fiat	Fij. cristal lateral Alfa Romeo 147, Fiat Dobló, Punto, Punto '99, Punto '03, Palio, Multipla, Uno, Lancia Lybra, Y, Y-10
162 317	VAG	Tope parachoques VW Golf, Polo
162 319	Opel	Fijac. moldura lateral puerta y aletas Ascona '82, Corsa A, Kadett E
162 320		universal
	Opel	Botón fijac. panel y tapicería todos los modelos (Blanco)
	PSA	Fijac. tapicería Berlingo, P-106, P-405, P-605, Partner (Blanco)
	Renault	Fijac. panel y tapicería todos los modelos (Blanco)
162 321		universal



INDICE REFERENCIAS

FAM. 0300	Marca	Descripción
162 324	Opel	Fijac. molduras - modelos antiguos -
162 325	Seat	Fijac. aislante motor 124, 131
162 326	universal	
	Fiat	Taco fijac. revestimientos interiores Fiat Cinquecento, Seicento, Punto, Uno, Tipo, Tempra, Regata, Ducato, Alfa Romeo
	Seat	Tuerca rápida varios usos
	VAG	Fijac. - varios usos - VW Golf '90
162 327	Renault	Fijac. molduras Express (metálica)
162 328	Renault	Tuerca bayoneta M-8 varios usos Renault
162 329	VAG	Tope goma Seat / VW
162 331	universal	
	VAG	Fijac. pasoruada y otros usos Audi 100, 200, A2, A3, A4, A5, A6, A6, Q5, Q7, TT, Seat Alhambra, Altea, Arosa, Ibiza/Cordoba, Inca, León/Toledo, Skoda Fabia, Octavia, Roomster, Superb, VW Bora, Caddy, Golf (todos), EOS, Fox, LT, Lupo, Passat, Phaeton, Polo, Scirocco, Sharan, Tiguan, Touran, Touareg, Transporter
162 332	universal	
162 341	universal	
	PSA	Remache fijac. aletas delanteras Saxo, P-106, P-605, fijac. parachoques trasero Jumpy I y II, P-309, Expert I y II
	VAG	Remache fijac. revestimientos interiores VW Polo
162 344	universal	
162 345	Opel	Fijac. faro Ascona C
162 347	PSA	Fijac. moldura lateral Visa, C-15
162 349	PSA	Fijac. moldura lateral Visa
162 351	Fiat	Fijac. rejilla Alfa Romeo 33, 75, 90
162 354	universal	
	Fiat	Botón fijac. revestimientos interiores Alfa Romeo 33/164
162 356	universal	
	Fiat	Tornillo fijac. parachoques Uno, Punto, Ducato
	Seat	Tornillo fijac. parachoques Panda (Ø 6 mm.)
162 357	universal	
	Fiat	Tornillo fijac. parachoques Uno, Regata, Y-10, Thema
	Seat	Tornillo fijac. parachoques Panda (Ø 8 mm.)
162 359	Fiat	Tuerca fijac. parachoques Fiat Cinquecento, Croma, Punto, Regata, Uno, Lancia Y-10 y Thema (monta con 162.363)
	Seat	Tuerca fij. parachoques Panda, Ritmo (monta con 162.363)
162 360	Seat	Fijac. moldura lateral Fura, Panda
162 362	universal	
	Fiat	Remache Ø 2,4 x 5, varias aplicaciones Cinquecento, Uno, Tipo, Tempra, Ducato, Alfa Romeo
	Ford	Remache Ø 2,4 x 5, varias aplicaciones
	Opel	Remache Ø 2,4 x 5, fijac. varias aplicaciones Ascona, Calibra, Corsa A y B, Kadett, Vectra A y B
	PSA	Remache Ø 2,4 x 5, fijac. molduras P-205, varios usos Citroen
	Renault	Remache Ø 2,4 x 5, varias aplicaciones
VAG	Remache Ø 2,4 x 5, varias aplicaciones	



INDICE REFERENCIAS

FAM. 0300	Marca	Descripción
162 363	universal	
	Fiat	Tornillo fijac. parachoques Fiat Cinquecento, Uno, Punto, Bravo/a, Marea, Regata, Croma, Ducato, Lancia Y-10, Thema (monta con 162.359)
	Seat	Tornillo fij. parachoques Panda, Ritmo (monta con 162.359)
162 364	Seat	Fijac. (c/inserto zincado) guardabarros Ritmo, Panda
162 368	universal	
	Fiat	Taco fijac. varios usos Uno, Tipo, Tempra, Punto, Y-10, Croma,
162 369	Fiat	Fijac. guardabarros, guarnición puerta y tapizados Alfa Romeo 145, 146, 147, 155, 156, fijac. guarnición puerta y tapizados Fiat Bravo/a, Croma, Dobló, Ducato, Marea, Multipla, Palio, Punto, Stilo, Tipo, Tempra, Uno, Lancia Y
162 370	PSA	Fijac. (con boca premontada) molduras BX, ZX, Xantia, Berlingo
	VAG	Fijac. moldura lateral parabrisas Skoda Fabia '07->, Roomster '06-> (Eurocode 7811ASCMS)
162 371	PSA	Fijac. apoyabrazos AX, BX, XM, ZX, P-106, P-205, P-405
162 372	Ford	Fijac. panel puerta Transit '00 y '06
	PSA	Fijac. panel puerta (con junta goma) AX, BX, C-15, Evasion, P-106, P-205, P-306, P-309, P-405, P-406, P-505, P-605, P-806
	Renault	Fijac. panel puerta y revestimientos interiores R-5, R-9/11, Super-5, Express, Master, Traffic
162 373	universal	
	Ford	Remache varios usos - varios modelos -
	Mercedes	Remache varios usos - varios modelos -
	Opel	Fijac. parachoques, spoiler y pasoruada Ascona, Astra H y J, Calibra, Corsa C y D, Meriva A y B, Insignia, Signum, Vectra A y C, Zafira B, fij. talonera puerta Astra J, Zafira C '12->
	PSA	Remache fijac. tapizados interiores y protecciones AX
	VAG	Remache fijac. pasoruada A3, A4, A6, Golf III y IV, Polo, Vento, fijac. parachoques VW Golf III y IV, Bora, New Beetle, Passat, Transporter, fijac. revestim. Passat
162 375	Ford	Tuerca especial redonda varios usos (Ø 6)
	PSA	Tuerca especial redonda varios usos (Ø 6)
	Renault	Tuerca especial redonda varios usos (Ø 6)
162 378	Fiat	Fijac. panel puerta Fiat Uno 1ª serie, Regata, Ducato
	Seat	Fijac. panel puerta 127, 131, Ritmo
162 379	Fiat	Fijac. panel puerta Alfa Romeo 145/146, Fiat Ducato '94, Uno, Y
	PSA	Fijac. panel puerta y revestimientos interiores C-25, J5
162 381	Ford	Fijac. tapizados interiores Escort '91-> y '97-> (color gris)
162 382	universal	
	Ford	Fijac. revestimientos interiores Fiesta, Escort, Transit (color gris)
162 383	universal	
	Ford	Fijac. revestimientos interiores Fiesta, Escort (color negro)
162 385	Ford	Fijac. tapicería Fiesta '89
162 389	universal	
	Fiat	Remache fijac. moldura exterior Panda '03, fijac. revestimientos interiores Cinquecento, Seicento y otros usos Fiat Uno, Croma, Ducato, Alfa Romeo - varios modelos -
	PSA	Remache fijac. varias aplicaciones Citroen
162 390	Fiat	Fijac. tirante bandeja trasera Fiat Uno, Punto, Palio, Lancia Y, Ypsilon, Alfa Romeo 33
162 391	Fiat	Fijac. moldura bajo puerta Fiat Uno Restyling 1ª serie



INDICE REFERENCIAS

FAM. 0300	Marca	Descripción
162 392	Fiat	Fijac. moldura bajo puerta Fiat Uno Restyling 2ª serie
162 393	Fiat	Fijac. guardabarros Fiat Uno, Cromo, Regata, Lancia Y-10 2ª serie
	Seat	Fijac. (c/inserto zincado) guardabarros Ritmo, Panda
162 395	Fiat	Tope parachoques posterior Izquierda Tipo, Tipo '93
162 396	Fiat	Fijac. parachoques Tipo, Tempra
162 397	universal	
	VAG	Tornillo fijac. parachoques delantero y trasero Seat Ibiza'93, Córdoba, VW Golf IV
162 398	Fiat	Fijac. revestimientos interiores Fiat Tipo, Tempra
162 399	Fiat	Fijac. panel puerta y revestimientos interiores Fiat Multipla, Panda '03, Punto '93, Seicento, Lancia Kappa, Lybra, Y
162 400	Fiat	Tope parachoques Uno, Cromo, Y-10, Thema
	Seat	Tope parachoques Panda
162 401	universal	
	Seat	Fijac. parrilla delantera 127, 131, 132
162 402	Seat	Fijac. panel puerta Panda
162 403	Fiat	Tope parachoques Tipo, Tempra, Dedra, Alfa 155
	VAG	Tope lateral parachoques VW Golf
162 404	Fiat	Tope parachoques Alfa - varios -, Lancia Dedra
162 405	Ford	Fijac. panel puerta Fiesta, Escort
	Seat	Fijac. panel puerta Panda (último modelo)
162 406	Fiat	Tope (goma) capó y portón Alfa Romeo 155, Fiat Cinquecento, Tipo, Tempra, Cromo, Ducato, Lancia Dedra, Nuevo Delta, Kappa
162 407	Fiat	Fijac. toma de aire Fiat Marea, Tipo, Tempra, fijac. pasoruada Fiat Bravo/a
162 408	Fiat	Boca panel puerta Bravo/a, Marea, Tipo, Tempra, Alfa 145, 146 y 155
162 409	Ford	Taco fijac. faro trasero Escort '95
162 410	Opel	Fijac. panel puerta Astra F, Ascona, Corsa A, Kadett
162 411	Opel	Fijac. moldura Corsa
162 412	Opel	Fijac. faro Corsa A
162 413	universal	
162 414	universal	
162 415	universal	
162 421	VAG	Fijac. panel puerta y revestimientos interiores VW Golf, Polo
162 423	Ford	Fijac. revestimientos interiores Fiesta
162 424	universal	
	Fiat	Fijac. revestimientos interiores Alfa Romeo 145, 146, 155, 166, Fiat Dobló, Tempra, Lancia Delta, Dedra, Kappa, Thesis
	Mercedes	Remache fijac. aletas y parachoques delantero y trasero Vito (W638), fijac. tapizados puerta lateral trasera y portón trasero Vito (W639) y otros usos - varios modelos -
	PSA	Remache fijac. varias aplicaciones Citroen, P-309
	Renault	Remache fijac. varios usos Super-5, Express
	VAG	Remache fijac. tapa filtro rejilla Seat León / Toledo '99->'05
162 425	universal	
	Ford	Remache pasoruada Fiesta, Escort



INDICE REFERENCIAS

FAM. 0300	Marca	Descripción
162 426	Renault	Fijac. varilla cerradura puerta R-11, R-19, Clio, Super-5, Express, Megane, Laguna, Safrane, Espace
162 427	Fiat	Fijac. varilla cerradura Tipo, Tempra, Ducato, Y-10
	Seat	Fijac. reenvío manecilla Ritmo, Panda, Marbella
162 428	Seat	Fijac. moldura talonera 850, 1430
162 429	VAG	Fijac. spoiler Seat Ibiza/Cordoba, Inca, VW Golf 23284, Polo 23295
162 430	PSA	Fijac. moldura parachoques delantero y trasero BX, P-205
162 431	universal	
	BMW	Remache fijac. varios usos
	Mercedes	Remache fijac. varios usos y modelos
	Opel	Fijac. varios usos - varios modelos -
	PSA	Remache fijac. varios usos XM, contorno puerta P-205, P-405, P-504
	VAG	Remache fijac. varios usos - varios modelos -
162 435	PSA	Tornillo fijac. parachoques P-205 (corto)
162 436	PSA	Tornillo fijac. parachoques P-205 (largo)
162 439	Fiat	Boca fijac. guardabarros Alfa Romeo 147, 156, 159, Fiat Bravo/a, Cinquecento, Dobló, Ducato, Marea, Seicento, Stilo, Palio, Punto, Punto '03, Grande Punto '05, Lancia Lybra, Y-10, Y
	PSA	Boca metálica para fijaciones puerta P-205, P-306, P-309
162 440	universal	
	PSA	Fijac. revestimientos interiores P-205, P-309
162 441	PSA	Fijac. revestimientos interiores Peugeot - varios modelos -
162 442	universal	
	Fiat	Clip fijac. guardabarros Fiat Bravo
	PSA	Clip fijac. pasoruedas ZX, Peugeot
	Renault	Clip (Ø 6) fijac. pasoruedas R-9/11, Clio, Super-5, Express, Laguna, Safrane, Espace, Master, Trafic
VAG	Clip fijac. pasorueda - varios modelos -	
162 444	universal	
	Fiat	Clip fijac. faro Fiat Bravo/a, Marea
	Renault	Clip fijac. protector - varios modelos -
162 446	PSA	Boca fijac. revestimientos AX, Berlingo, C8, C6, Evasion, Jumpy I y II, XM, Xantia, Xsara, ZX, P-306, P-806, P-807, Expert I y II, Partner, fijac. aletas P-406 Coupé (monta con 162.447 y 162978)
162 447	universal	
	PSA	Fijac. revestim. interiores AX, BX, ZX, XM, Xantia, P-106, P-205 (monta con 162.446)
162 449	Seat	Grapa fijación rápida 3 mm. varios usos
162 450	universal	
	Renault	Fij. aislante motor R-19, R-21, R-25, Clio, Super-5, Kangoo, Express, Megane, Modus, Laguna, Safrane, Master, Traffic
162 451	Renault	Fijac. revestimientos interiores R-9/11, R-5, Super-5, Express
162 452	Renault	Fijac. revestimientos interiores R-9/11, R-21, Super-5, Express
162 453	universal	
	Mercedes	Botón fijac. tapizados puertas laterales y traseras Vito (W638)
	PSA	Fijac. revestimientos interiores - varios modelos -
	Renault	Fij. tapizados interiores R-9, R-11, R-19, R-21, R-25, Super-5, Express, Clio, Megane, Twingo, Laguna, Safrane, Espace



INDICE REFERENCIAS

FAM. 0300	Marca	Descripción
162 454		universal
	PSA	Fijac. tapizados AX, BX, C-15, ZX, parachoques trasero Xsara II, P-306, fijac. aletas delanteras ZX, fijac. cablería capó C4 Picasso
	Renault	Fijac. revestimientos interiores R-9/11, R-5, R-18, R-19, Super-5, Express, Espace, Safrane
162 456		universal
	BMW	Fijac. bajos carrocería serie 1 (E81,82,87,88), serie 3 (E90,91,92,93), X1, fijac. pasoruada serie 3 (E46), serie 5 (E39,60,61,65,66,67, F01,02,03,04,07,10,11), serie 6 (F12), Z4 (E89)
	Mercedes	Remache fijac. varios usos y modelos
	PSA	Remache fijac. revestimientos interiores - varios modelos -
	Renault	Remache fijac. revestim. interiores R-5, R-19, Super-5, Express
	VAG	Remache revestim. interiores - varios modelos -
162 457		universal
	Seat	Fijac. tapicería 127
162 462	Renault	Fijac. molduras laterales R-21
162 463	Renault	Fijac. vierteaguas techo Clio
162 465	Fiat	Fijac. panel puerta Iveco
	Ford	Fijac. parachoques - varios modelos -
	PSA	Fijac. (Ø 6) varios usos
	Renault	Fijac. varios usos R-9/11, R-19, R-21, Super-5, Express, Clio, Laguna, Safrane, Espace, Twingo, Master, Traffic
162 466	Renault	Fijac. tirante bajopuerta R-19, R-21, Super-5, Express, Clio, Master, Traffic
162 468	Renault	Taco fijac. revestimiento puerta Megane, fijac. apoyabrazos Clio
162 471	Renault	Fijac. anagrama capó Clio, Espace, Express, Master, Safrane, Super-5, Traffic, Twingo
162 472	Renault	Fijac. vierteaguas Twingo, Megane, Scénic, Master, Traffic
162 473	Renault	Fijac. molduras laterales Clio (1ª serie) (color blanco)
162 474	Renault	Fijac. molduras laterales Clio (1ª serie) (color rojo)
162 475	Fiat	Fijac. junta estanqueidad puerta Fiat Palio, Siena, Strada
	Renault	Fijac. junta estanqueidad puerta Clio I
162 477	Renault	Fijac. junta estanqueidad puerta Clio I
162 478		universal
	Renault	Tornillo Ø 6,3 x 16, fijac. guardabarros R-9/11, R-19, R-21, Clio, Super-5, Express, Megane, Laguna, Safrane, Twingo, Master, Traffic
162 479		universal
	Renault	Clip (Ø 6,35) fijac. guardabarros R-9/11, R-19, R-21, R-25, Clio, Super-5, Express, Laguna, Twingo, Master, Traffic
162 480		universal
	Ford	Taco fijación puerta Escort '95, Fiesta '89, Focus, Ka, Mondeo '93-'00
162 481		universal
	PSA	Remache fijac. varios usos AX, XM, Xantia
	Renault	Remache fijac. junta puerta Laguna III, y otros usos R-19, R-21, Super-5, Express, Kangoo, Laguna
162 483		universal
	Renault	Taco fijac. guía puerta y tapicería Twingo, Master, Traffic
162 485	Dacia	Fijac. varilla cerradura puerta Logan
	PSA	Fijac. varilla cerradura puerta Evasion, P-307, P-806
	Renault	Fijac. varilla cerradura puerta Clio, Espace, Super-5, Express, Safrane, Twingo, Master, Traffic



INDICE REFERENCIAS

FAM. 0300	Marca	Descripción
162 488	Renault	Fijac. molduras laterales Clio (2ª serie) (color blanco)
162 489	Renault	Fijac. molduras laterales Clio (2ª serie) (color rojo)
162 490	universal	
	Renault	Tornillo fijac. guardabarros R-19, R-21, R-25, Clio, Super-5, Express, Safrane
162 491	Seat	Fijac. luz matrícula 127, 132, 133
162 492	Seat	Fijac. autoroscante Seat - varios modelos -
	universal	
162 493	Fiat	Fijac. tapizados Fiat Punto '99->'03, Palio, Siena, Uno, Fiorino, Lancia Y-10, Thema
	Seat	Fijac. tapizados Seat - varios modelos -
162 494	Seat	Regulador faro 127, 131, 132, Ritmo
162 499	Seat	Fijac. tubos universal - varios modelos -
162 500	VAG	Fijac. moldura piso puerta VW Golf II
162 501	PSA	Fijac. aletas, tapizados y panel puerta Berlingo, Partner, ZX, fijac. moldura portón trasero Berlingo, Partner, XM
	VAG	Fijac. moldura VW Golf '90, Passat, Jetta, Vento
162 502	VAG	Fijac. moldura y protector guardabarros VW Golf '88-'90
162 503	VAG	Fijac. panel puerta VW Golf, Polo
162 504	VAG	Fijac. guarnecidos contorno capó motor Seat Alhambra '97->'09, Toledo '92->'99, VW Golf '84->'92, Lupo, Polo '02->'05, Sharan '96->'09, LT, Transporter '96->'04
	universal	
162 505	Mercedes	Remache fijac. revestimientos interiores - varios modelos -
	VAG	Remache fijac. revestimientos interiores VW Golf y LT
162 506	VAG	Fijac. varilla capó Seat Alhambra '97->'00, VW Golf '92->'98, Passat, Sharan '96->'00
162 510	Fiat	Fijac. panel puerta Alfa Romeo 145, 146, 156, 166, GT, Fiat Bravo/a, Cromia, Dobló, Marea, Panda '03, Punto, Tipo/Tempra, Lancia Nuevo Delta, Y, Ypsilon
162 511	Fiat	Boca panel puerta y revestimientos interiores Fiat Cromia, Multipla, Palio, Punto -todos-, Seicento, Stilo, Strada, Lancia Kappa, Lybra, Y, Ypsilon
162 512	universal	
	Fiat	Botón fijac. antivibrador parachoques delantero Fiat Punto y fijac. tapizados interiores Alfa Romeo 156, Fiat Ducato, Palio, Siena
	PSA	Fijac. aletas delanteras y tapizados interiores Boxer I, II y III, Jumper I, II y III
162 514	Fiat	Tope antivibrador parachoques delantero Punto
162 515	Fiat	Fijac. varilla capó Fiat Punto, Lancia Y, Ypsilon
162 516	Fiat	Fijac. varilla capó Fiat Punto, Punto '99 y '03, Lancia Dedra, Nuevo Delta, Kappa
162 517	universal	
	Fiat	Remache fijac. panel puerta Fiat 500 '07->, fij. revestimientos interiores Cinquecento, Punto, Bravo/a, Marea, Siena, Tipo, Tempra, Ducato, Alfa Romeo 145, 146, 156, GT, Lancia Dedra, Lybra, Thema
162 518	PSA	Fijac. apoyabrazos AX, BX, ZX, Evasion, P-106, P-205/309, P-806
162 519	universal	
	Fiat	Fijac. motor Uno, Punto, Bravo/a, Marea, Palio, Siena, Tipo, Tempra, fij. guarnición puerta Cromia
162 520	Seat	Fijac. tubo freno Seat (Ø 7 / 7)



INDICE REFERENCIAS

FAM. 0300	Marca	Descripción
162 523	universal	
	Fiat	Taco fijac. revestimientos interiores Fiat Cinquecento, Uno, Punto, Bravo/a, Marea, Tipo, Tempra, Alfa 145, 146 y 156
	PSA	Fijac. varios usos Berlingo, C4, C4 Picasso, C5, C6, C8, Evasion, Jumpy, Saxo, Xantia, XM, Xsara, Xsara Picasso, P-106, P-205, P-206, P-207, P-308, P-309, P-405, P-406, P-407, P-605, P-607, P-806, P-807, P-1007, Expert, Partner
	Renault	Taco fijac. varios usos R-9/11, Clio, Super-5, Express, Megane, Laguna, Safrane, Twingo, Espace, Master, Traffic
162 524	Fiat	Tope (goma) capó y portón Alfa Romeo 147, 156, Fiat Bravo/a, Dobló, Marea, Punto -todos-, Palio, Seicento, Lancia Lybra, Y
162 525	Fiat	Boca fijac. guardabarros Fiat Bravo/a, Marea, Punto
162 526	universal	
	Fiat	Tornillo fijac. guardabarros Punto, Tipo, Tempra
162 527	Fiat	Boca fijac. guardabarros Alfa Romeo 145, 146, 147, 156, Fiat Bravo/a, Cromo'05, Marea, Punto, Punto '03, Strada, Uno, Lancia Y-10, Y
162 528	universal	
	Fiat	Tornillo fijac. guardabarros delantero Bravo/a, Dobló, Ducato, Punto '99, Lancia Lybra, Y
162 529	universal	
	Fiat	Tornillo fijac. parachoques Fiat Bravo/a, Dobló, Grande Punto '05, Marea, Punto '99 y '03, Lancia Kappa, Thesis, Y
162 530	Fiat	Fijac. panel puerta Fiat Tipo, Tempra 1ª serie, Cinquecento
162 531	Fiat	Boca panel puerta Fiat Cinquecento, Tipo, Tempra, Ducato, Alfa Romeo 164
162 532	Seat	Fijac. tubos Seat (Ø 8)
162 533	Fiat	Fijac. faro Fiat Cinquecento, Alfa Romeo - varios -
	Seat	Fijac. faro delantero Panda
162 534	universal	
	Fiat	Taco fijac. revestimientos interiores y pasoruada Fiat Bravo/a, Cinquecento, Cromo, Marea, Regata, Seicento, Uno, Lancia Y-10, Y
	Seat	Tuerca rápida varios usos
162 535	Fiat	Fijac. faro Bravo/a, Cinquecento, Dobló, Marea, Seicento
162 536	Fiat	Tope parachoques delantero Cinquecento
162 538	Seat	Fijac. tubo freno Seat
162 541	Seat	Fijac. punta parachoques 131
162 542	Seat	Tapón carrocería Panda
162 545	universal	
	Fiat	Fijac. rejilla Fiat Uno, paneles Fiat Tipo, Tempra, varios usos Alfa Romeo
	Seat	Fijac. autoroscante rejilla 127, Panda
162 547	PSA	Fijac. varilla cerradura Peugeot
162 548	Ford	Fijac. tapicería (color verde)
162 549	PSA	Fijac. tapizados interiores Peugeot/Talbot
162 551	Seat	Tapón carrocería Seat
162 553	Seat	Fijac. panel puerta Seat - varios modelos - (color blanco)
162 554	Mercedes	Fijac. panel puerta Mercedes Vito (W638) y otros modelos
162 555	Ford	Tornillo Ø 5,5 x 19 (aro Ø 18), sujeción guardabarros -varios modelos -
	Opel	Tornillo Ø 5,5 x 19 (aro Ø 18), sujeción guardabarros
	VAG	Tornillo Ø 5,5 x 19 (aro Ø 18), sujeción guardabarros



INDICE REFERENCIAS

FAM. 0300	Marca	Descripción
		universal
162 556	BMW	Tornillo Ø 6,2 x 19 (aro Ø 18), sujeción guardabarros
	Ford	Tornillo Ø 6,3 x 19 (aro Ø 18), sujeción guardabarros -varios modelos -
	Mercedes	Tornillo Ø 6,3 x 19 (aro Ø 18), sujeción guardabarros
	Opel	Tornillo Ø 6,3 x 19 (aro Ø 18), sujeción guardabarros
	VAG	Tornillo Ø 6,3 x 19 (aro Ø 18), sujeción guardabarros
162 557	Seat	Fijac. molduras - varios modelos -
162 558	Seat	Fijac. cables faro a rejilla Ibiza
162 562	VAG	Fijac. - varios usos - Seat Ibiza , fij. manecilla apertura puerta Audi 100, 200, A3 '97->'03, A4 '95->'01, A6 '95->'97, A8
162 563	Seat	Fijac. moldura lateral 131 Supermirafiori
162 564	Seat	Bloqueador tornillo 131
162 565	Seat	Bisagra cristal lateral Tras. Dcho. Ibiza hasta '92 (3 puertas)
162 566	Seat	Bisagra cristal lateral Tras. Izdo. Ibiza hasta '92 (3 puertas)
162 567	Seat	Tope parachoques Ibiza, Toledo
162 568	Seat	Fijac. cables Ritmo, Ibiza (Ø 5 / 25)
162 570		universal
162 571	Seat	Fijac. parrilla 131
162 575		universal
162 579		universal
	Seat	Fijac. tapizados interiores Panda (Gris)
162 580		universal
	Seat	Fijac. tapizados interiores Panda (Negro)
162 585		universal
162 588		universal
162 589		universal
162 590		universal
162 591		universal
	Renault	Clip (Ø 3,9) fijac. varios usos
162 595	Renault	Fijac. letreros R-5
162 598	Fiat	Fijac. panel puerta Regata
	Seat	Fijac. panel puerta Ritmo, 132
162 599	Seat	Contrabroche panel Panda
162 600		universal
162 602		universal
162 603		universal
162 608	Seat	Fijac. tubos - varios modelos -
162 609		universal
	Seat	Fijac. placa matrícula, modelos antiguos
162 610	Seat	Fijac. letreros 131
162 611		universal



INDICE REFERENCIAS

FAM. 0300	Marca	Descripción
162 613	universal	
162 614	universal	
162 615	Seat	Fijac. tapizados Ritmo
162 618	Ford	Fijac. letreros Fiesta
	PSA	Fijac. moldura techo P-207, P-307
162 619	universal	
	Renault	Tornillo fijac. parachoques R-5
162 624	universal	
	Fiat	Remache fijac. parachoques Fiat Panda '03->
	PSA	Remache fijac. parachoques Citroen/Peugeot
162 625	universal	
162 626	universal	
162 627	universal	
162 628	universal	
162 629	universal	
162 630	Opel	Fijac. panel puerta Kadett
162 632	universal	
	Ford	Fijac. pasoruada Galaxi '94->'06
	VAG	Fij.pasoruada y revestimientos interiores Audi TT, Seat Ibiza/Cordoba '99->'02, VW Bora, Golf, Passat, New Beetle, fijac. parachoques Seat Alhambra, VW Caddy '04, LT, Passat ->'97, Phaeton, Sharan, Touareg, Transporter, fijac. parrilla radiador Leon '99, Toledo '99, Polo, fij. armazón delantero Golf III
162 633	PSA	parrilla lavaparabrisas "torpedo" XM (Eurocode 2718ASCHB) (monta con 162.676)
	PSA	Fijac. panel puerta y revestimientos interiores AX, Xantia, XM, Xsara, ZX, P-306, P-309, Expert (monta con 162.676)
162 634	universal	
	Renault	Clip (Ø 6,3) fijac. varios usos
162 635	universal	
	Renault	Clip fijac. piloto delantero R-5
162 640	Seat	Tapón tensor asiento posterior Panda
162 641	Seat	Tapón taladros Panda
162 643	universal	
	Renault	Fijac. tapizados interiores - varios modelos -
162 646	universal	
	Renault	Fijac. tapizados interiores - varios modelos -
162 647	universal	
	Renault	Remache fijac. varios usos Renault
162 648	PSA	Boca (Ø 10) para revestimientos interiores ZX, Xantia, P-106, P-205, P-306, P-405, P-605
	Renault	Boca (Ø 10) para revestimientos montante Megane
162 649	universal	
	Renault	Taco fijac. varios usos Renault
162 651	Ford	Fijac. tubo lavacrystal y varilla capó Fiesta '89



INDICE REFERENCIAS

FAM. 0300	Marca	Descripción
162 656	universal	
	PSA	Fijac. tapizados piso Xantia I y II, ZX
162 657	Renault	Fijac. pasoruada R-19, R-25, Clio, Super-5, Express, Kangoo, Megane, Twingo, Laguna, Safrane, Master, Traffic
	universal	
162 658	PSA	Fijac. revestimientos interiores AX, C-15, Saxo, P-106, P-205, P-206, P-306, P-309, P-405, P-406, P-605
	universal	
162 659	Ford	Botón fijac. aislamiento capó y tapizados interiores Connect, Cougar, Fiesta '01 y '08->, Focus '98, Escort, Ka, Mondeo '94->'07, Puma, Transit '00 y '06->, Transit Connect '02
	VAG	Fijac. revestimientos interiores - varios modelos -
162 660	universal	
	Fiat	Botón fijac. revestimientos interiores Cinquecento, fijac. aislante capó Tipo, Tempra
162 664	PSA	Fijac. revestimiento interior AX, BX, ZX
	universal	
162 665	VAG	Remache fijac. guarnición capó VW, Audi
	universal	
162 666	VAG	Remache fijac. rejilla radiador y spoiler VW Caddy ->'92, Golf I y II, Transporter T2 ->'92
	universal	
162 667	VAG	Remache fijac. guarnición puerta Audi 80, 90 y coupé, A4 '95
	PSA	Fijac. panel puerta (con junta goma) Evasion, Jumpy I y II, P-205, P-806, Expert I y II
162 668	Renault	Fijac. panel puerta R-21, R.25, fijac. embellecedor exterior techo Megane II, Traffic II
162 669	Renault	Fijac. panel puerta y revestimientos interiores Kangoo, Laguna, Safrane
162 670	VAG	Fijac. panel y revestimientos interiores VW Golf III / IV (monta con 162.671)
162 671	VAG	Fijac. panel y revestimientos interiores VW Golf III / IV (monta con 162.670)
162 672	Renault	Fijac. (con boca premontada) revestimientos interiores Super-5
162 673	Renault	Fijac. revestimientos interiores Super-5, Express
162 674	VAG	Fijac. revestimientos interiores Seat Toledo '92->'99, VW Golf ->'92, Passat ->'99, Transporter '91->'04
	PSA	Boca (Ø 8) para panel puerta ZX
162 675	Renault	Boca fijac. panel puerta y tapizados R-21, Super-5, Express, Laguna
	PSA	Boca (Ø 8,2) para panel puerta Berlingo, Evasion, Jumpy I y II, Xsara Picasso, P-106, P-205, P-306, P-309, P-405, Expert I y II, Partner (monta con 162.633)
162 677	VAG	Fijac. moldura VW Golf
	Fiat	Fijac. molduras Lancia Dedra, Thema
162 679	Seat	Fijac. molduras 124, 127
	Fiat	Fijac. moldura Fiat Scudo, Ulisse, Lancia Delta moderno, Zeta
162 680	PSA	Fijac. moldura lateral Evassion, P-806
	Renault	Fijac. molduras laterales Megane, Scénic (color blanco/rojo)
162 682	Renault	Fijac. molduras laterales Megane, Scénic (color blanco/azul)
162 683	Renault	Fijac. molduras laterales Laguna (color verde)
162 684	Renault	Fijac. molduras laterales Laguna (color blanco)
162 685	Renault	Fijac. molduras laterales Laguna (color rojo)
162 686	Renault	Fijac. molduras laterales Laguna (color gris)
162 687	Renault	Fijac. molduras laterales Laguna (color blanco)



INDICE REFERENCIAS

FAM. 0300	Marca	Descripción
162 688	PSA	Fijac. moldura portón P-205
162 689	VAG	Fij. moldura techo Seat Ibiza/Cordoba '93->'99, Inca '96->'01, Toledo '92->'99, VW Caddy '96->'03, Golf '84->'92, Passat '88->'97, Polo Classic '96->'00 (Eurocode 7603ASCS y 7603ASCH)
162 690	VAG	Fijac. moldura techo VW Golf III '92->'99, Vento (Eurocode 8541ASCH)
162 691	Fiat	Fijac. moldura parachoques Fiat Tipo, Tempra
162 692	PSA	Fijac. spoiler a parachoques C3, P-106, P-205, fijac. rejilla aire P-405
162 694	Renault	Fijac. parachoques posterior Twingo
162 696	Fiat	Fijac. guardabarros Alfa Romeo 145 / 146 / 155, Fiat Tipo, Tempra, Lancia Delta, Dedra
162 697	Fiat	Fijac. guardabarros Alfa Romeo 145 / 146 / 155, Fiat Cinquecento, Seicento, Croma, Tipo, Tempra, Lancia Delta, Nuevo Delta, Dedra
162 699	Fiat	Fijac. panel puerta Bravo/a, Marea
162 700	Renault	Fijac. anagrama capó Clio, Espace, Laguna, Master, Megane, Safrane, Traffic, Twingo
162 701	Renault	Fijac. anagrama portón y siglas modelo Clio, Express, Laguna, Master, Megane, Safrane, Super-5, Traffic, Twingo
		universal
162 702	Renault	Tornillo Ø 4,2 x 17 (aro Ø 14), fijac. pasoruada Laguna, Twingo
	VAG	Tornillo Ø 4,2 x 17 (aro Ø 14), fijac. pasoruada y revestimientos - varios modelos -
162 704	VAG	Fijac. tapizados interiores y parachoques Audi 80, 90, 100, A4, A6
		universal
162 705	Renault	Fijac. spoiler a parachoques delantero Clio
		universal
162 706	Fiat	Botón fijac. aislante capó Fiat Cinquecento, Uno, Punto, Bravo/a, Marea, Croma, Lancia Y-10, fijac. panel puerta Alfa Romeo Brera
162 708	PSA	Remache fijac. tirante bandeja posterior C2, C3, DS3, Saxo, XM, Xsara Picasso, P-106, P-205, P-206, P-306, P-307, P-308
	VAG	Fijac. tirante bandeja posterior VW Golf III
		universal
162 710	Fiat	Tornillo fijac. pasoruada y tapizados interiores Alfa Romeo 147, 156, 166, Fiat Bravo/a, Croma '05, Marea, Multipla, Punto '99 y '03, Tipo, Tempra, Lancia Lybra, Kappa, Y, Ypsilon
		universal
	Dacia	Tuerca con aro móvil (Ø 6), fijac. emblema trasero Duster
	Ford	Tuerca con aro móvil, varios usos
162 711	Opel	Tuerca con aro móvil, varios usos
	PSA	Tuerca con aro móvil (Ø 6), varios usos
	Renault	Tuerca con aro móvil (Ø 6), varios usos Megane, Laguna
	VAG	Tuerca c/aro móvil (Ø 6), varios usos
		universal
	Ford	Tuerca con aro móvil, varios usos
	Opel	Tuerca con aro móvil, varios usos
162 712	PSA	Tuerca con aro móvil (Ø 8), varios usos
	Renault	Tuerca con aro móvil (Ø 8), varios usos Clio, Twingo
	VAG	Tuerca c/aro móvil (Ø 8), varios usos
162 713	Seat	Fijac. panel puerta 127



INDICE REFERENCIAS

FAM. 0300	Marca	Descripción
162 714	Fiat	Fijac. panel puerta Tipo, Tempra, Uno, Alfa 33, Lancia Y-10, Delta
	PSA	Fijac. panel puerta P-306, P-406
162 715	universal	
	Ford	Taco fijac. pasoruada y varios usos Escort '95, Fiesta '89-'96, Fiesta '96, Focus '98, Galaxi '06, Ka '97, Puma '98, Mondeo '97, S-Max
162 716	VAG	Fijac.matrícula - varios modelos -
162 717	universal	
	Renault	Taco fijac. revestimiento portón Laguna
162 718	universal	
	Fiat	Fijac. pasoruada Fiat Punto, revestim. interiores Fiat Tipo, Tempra
162 720	Ford	Taco fijac. pasoruada Ford - varios -
	Fiat	Fijac. lateral faro Bravo/a, Ducato, Ducato '02, Marea
162 721	VAG	Fijac. indicadores y luz de freno VW TT
	Renault	Tope (goma) capó Clio
162 722	Renault	Fijac. varilla capó Clio, Express
162 723	Renault	Fijac. varilla capó Super-5, Express, Megane, Laguna, Master, Traffic
162 724	Renault	Fijac. varilla capó Twingo
162 725	Fiat	Fijac. escudo frontal Alfa Romeo 75, 90, 145, 146, 164
162 727	Renault	Fijac. mecanismo alzacratales R-19, Clio, Espace IV, Megane, Laguna II, Vel Satis (Eurocode 7239LSCHFD)
162 728	Renault	Fijac. mecanismo alzacratales Clio, Laguna, Safrane, Espace
162 730	Mercedes	Fijac. moldura techo-parabrisas (190-202) (Eurocode 5328ASCST)
162 731	Mercedes	Fijac. moldura techo-parabrisas (190-202) (Eurocode 5328ASCST1B)
162 732	Mercedes	Fijac. moldura techo (190-202)
162 733	Mercedes	Fijac. moldura (124)
162 734	Mercedes	Fijac. moldura puerta Clase C (W202, W203), Clase E (W211), Sprinter, Vito (W638/639)
162 735	Mercedes	Fijac. moldura (190)
162 736	Mercedes	Fijac. moldura (190)
162 737	Mercedes	Fijac. moldura (190)
162 738	Mercedes	Boca de fijación para perno moldura lateral (190-202)
162 739	Mercedes	Fijac. moldura (190)
162 740	Mercedes	Fijac. moldura (190)
162 741	Mercedes	Fijac. moldura (190)
162 744	Mercedes	Fijac. moldura (190)
162 745	Mercedes	Fijac. moldura (190)
162 746	Mercedes	Boca fijac. moldura - varios modelos -
162 747	Mercedes	Fijac. moldura (190)
162 748	Mercedes	Fijac. moldura (124)
162 749	Mercedes	Fijac. moldura (190)
162 751	Mercedes	Fijac. moldura (190)
162 752	Mercedes	Fijac. moldura (190-202)



INDICE REFERENCIAS

FAM. 0300	Marca	Descripción
162 753	universal	
	Mercedes	Botón fijac. tapizados interiores - varios modelos -
162 759	VAG	Fijac. rejilla aire a capó VW Golf III '92-'99, Inca (monta con 162.760) (Eurocode 8541ASCBH1)
162 760	VAG	Boca fijac. rejilla aire a capó VW Golf III '92->'99, Inca (monta con 162.759)
162 761	VAG	Botón obturación agujeros puerta VW Golf III
162 762	VAG	Fijac. varilla capó VW Golf IV y V, Polo '95->'00, Bora '99
162 763	VAG	Fijac. derecha rejilla frontal VW Polo '95
162 764	VAG	Fijac. izquierda rejilla frontal VW Polo '95
162 765	universal	
	VAG	Fijac. rejilla parabrisas "torpedo" VW Golf III, Skoda Octavia '97-> (Eurocode 8541ASCHB)
	VAG	Remache fijac. rejilla parabrisas "torpedo" VW Golf III, Skoda Octavia '97->
162 766	universal	
	VAG	Remache fijac. revestimientos interiores VW Golf III, Passat '92->'05
162 767	VAG	Fijac. revestimiento portón Skoda Octavia '97->, VW Golf III, Polo '95->'02
162 768	VAG	Boca centraje rejilla delantera VW Golf III
162 769	VAG	Fijac. panel puerta VW Golf III (monta con 162.770)
162 772	VAG	Fijac. revestimientos interiores laterales VW Golf III (sin espuma antivibrante)
162 773	VAG	Fijac. revestimientos interiores laterales VW Golf III (sin espuma antivibrante)
162 774	universal	
	VAG	Fijac. pasoruada y tapizados interiores Audi 100, 200, A2, A3, A4, A5, A6, A6, Q5, Q7, TT, Seat Alhambra, Altea, Arosa, Ibiza/Cordoba, Inca, León, Toledo, Skoda Fabia, Octavia, Roomster, Superb, VW Bora, Caddy, Golf (todos), EOS, Fox, LT, Lupo, Passat, Phaeton, Polo, Scirocco, Sharan, Tiguan, Touran, Touareg, Transporter
162 775	universal	
	VAG	Fijac. pasoruada Seat León '13, VW Fox '05, Gol, Polo Classic '04
162 776	universal	
	VAG	Fijac. parachoques, rejilla radiador y revestimientos interiores Audi A4 '01, A8, Seat Alhambra, Altea, Arosa, Ibiza, Cordoba, León/Toledo, VW Bora, Caddy, Golf III, IV y V, Jetta, Lupo, New Beetle, Passat, Polo Classic, Sharan, Transporter
162 777	VAG	Fijac. metaloplástica revestimientos interiores Seat Arosa, VW Lupo, Polo '95->'02
162 778	VAG	Botón fijac. revestimientos interiores Skoda Fabia '00, Octavia '97, VW Golf III
162 779	VAG	Fij. tapizados portón y otros usos interiores Seat Alhambra '96->'09, Arosa, Ibiza/Cordoba '93->'09, Inca, León '99->'05, Toledo '99->'05, Skoda Octavia '97->'09, Superb, VW Caddy '96->'03, EOS, Golf III, IV y VI, Jetta, Passat ->'05, Phaeton, Polo '95->'09, Scirocco '09, Sharan '96->'09, Touran, Transporter '03->
162 780	universal	
	Mercedes	Botón fijac. tapizados interiores Clase C (W202/W203/W204), Clase E (W210/211/212), Sprinter
162 781	VAG	Fijac. revestimientos interiores VW Golf III
	universal	
	VAG	Fijac. revestimientos interiores VW Golf III, Transporter '99->'04



INDICE REFERENCIAS

FAM. 0300	Marca	Descripción
		universal
162 782	BMW	Fijac. revestimientos interiores E23, E24, E28
	Ford	Botón fijac. revestimientos e insonorizante capó Focus '98, Mondeo
	Opel	Fijac. deflector aire Signum, Vectra C
	VAG	Fijac. revestimientos interiores Audi A3 '04->, A4 '95->, A5, A6 '95->, Q5, TT, Seat Inca '96->'04, Skoda Fabia, Roomster, Superb, VW Caddy '96->'03, Golf III, LT, Polo '95->'02, Transporter
162 783	VAG	Fijac. rejilla toma aire a parachoques VW Polo '95
162 784	VAG	Fijac. panel puerta y revestimientos interiores VW Golf III, Golf IV (tipo corto)
162 785	VAG	Fijac. moldura VW Golf, Passat, Polo, Transporter (monta con 162.786)
162 786	VAG	Boca fijac. moldura VW Golf, Passat (monta con 162.785)
162 787	VAG	Fijac. moldura parabrisas Seat Altea, Toledo '05
	VAG	Fijac. spoiler Seat Ibiza '93, Leon '99->'05, Toledo '99->'05, fijac. moldura a guardabarros VW Golf III, Passat
162 788	VAG	Fijac. moldura lateral VW Passat '94->'97
162 789	VAG	Fijac. moldura lateral VW Passat '97->'04
162 790	VAG	Fijac. moldura lateral VW Passat '94->'97
162 791	VAG	Fijac. moldura lateral VW Passat '97->'04
162 792	VAG	Fijac. moldura lateral Audi A3, A4, A6, A8
162 793	VAG	Fijac. moldura lateral Audi A3, A4, A6, A8
162 794	VAG	Fijac. moldura lateral Audi A3, A4, A6, A8
162 796	VAG	Fijac. moldura lateral Audi A3, A4, A6, A8
162 798	PSA	Fijac. seguro puerta P-405, P-806
	Renault	Fijac. seguro puerta Laguna, Safrane
162 799	PSA	Fijac. seguro puerta P-306
162 800	PSA	Fijac. moldura lateral AX, C-15, ZX
162 801	PSA	Fijac. moldura pasoruada y bajopuerta AX
162 802	PSA	Fijac. moldura pasoruada y bajopuerta AX, Saxo, ZX
162 803	PSA	Fijac. revestimiento portón trasero y paneles laterales/puerta Berlingo, C3 Picasso y Pluriel, C5 '01->'04, Saxo, XM, Xsara I y II, Xsara Picasso, P-406, Partner
162 804	PSA	Fijac. (Ø 9,5) moldura puertas, aletas, talonera puerta y otros usos Berlingo, C2, C5, C6, Xantia, Xsara I y II, Xsara Picasso, Saxo, P-206, P-306 restyling, P-307, P-406, P-407, Partner
162 805	PSA	Fijac. rejilla calandra Evasion, Jumpy I y II, P-206, P-806, Expert I y II, fijac. retrovisor P-206, fijac. moldura aletas, puerta y talonera P-106 Restyling, P-306
		universal
162 806	PSA	Fijac. aletas delanteras y traseras y tapizados interiores Berlingo, BX, C5, C8, Evasion, Saxo, Xantia, XM, Xsara II, Xsara Picasso, Jumpy I y II, P-106, P-306, P-405, P-406, P-806, P-807, Expert I y II, Partner, fijac. rejilla lavaparabrisas Xantia I y II
	PSA	Fijac. mecan. alzacristales AX, Saxo, ZX, XM, P-106, P-306, P-406
162 808	PSA	Fijac. mecan. alzacristales AX, Saxo, ZX, XM, P-106, P-306, P-406
162 809	Opel	Fijac. faro Corsa B '93, Tigra
162 810	Ford	Fijac. panel puerta Fiesta '89-'96, Escort '95, Ka '97
162 811		universal
	Ford	Taco fijac. rejilla radiador Fiesta '89-'96, Escort '95, Mondeo '97, Ka '97, Puma '98, y fijación óptica delantera Ka



INDICE REFERENCIAS

FAM. 0300	Marca	Descripción
162 812	universal	
	Ford	Fij. rejilla parabrisas "torpedo" Fiesta, Escort, Sierra, Mondeo, Transit '86->'97 (Eurocode 3731ASCBS / 3539ASCHS)
	Ford	Remache rejilla parabrisas "torpedo" Fiesta, Escort, Sierra, Mondeo, Transit ->'97 (Eurocode 3731/3539ASCBS)
	VAG	Remache fijac. tapizados interiores Audi A6 '05, Seat Altea, León '05, Toledo '05, VW Caddy '04, Golf V y VI, EOS, Jetta, New Beetle, Passat '05, Scirocco '09, Tiguan, Touran
162 813	PSA	Fijac. varilla cerradura Peugeot
162 814	PSA	Fijac. varilla capó AX, C3, C4, C-15, Evasion, Saxo, P-106, P-306
162 815	universal	
	Fiat	Botón fijac. revestimiento capó Alfa Romeo 155, Fiat Bravo/a, Uno, Tipo, Lancia Dedra, Delta
162 816	PSA	Fijac. moldura aletas y puerta P-106 restyling, P-406
	Renault	Fijac. rejilla parabrisas Vel Satis
	Renault	Fijac. tapizados interiores - varios modelos -
162 817	universal	
	Nissan	Taco fijac. varios usos - varios modelos -
	VAG	Fijac. faro Audi / VW
162 818	VAG	Fijac. tubo aire cierre centralizado VAG
162 819	universal	
	Opel	Fijac. molduras parachoques y fijac. pasoruedas Astra F, Calibra, Corsa A y B, Kadett, Omega, Vectra A
	Renault	Remache fijac. embellecedor exterior del retrovisor Twingo II
162 821	universal	
	VAG	Remache fijac. varios usos Audi A1, A3, A4 '08, A5, A8, Q7, Seat León '99->'05, Toledo '99->'05, Skoda Fabia, Octavia, Roomster, VW Bora, Golf IV, LT, New Beetle, Passat, Touran, Touareg, Transporter '03->
162 823	universal	
	Renault	Fijac. tapizados interiores - varios modelos -
	Seat	Fijac. tapizados Seat
162 824	Opel	Fijac. moldura lateral Vivaro (componente del kit OEM: 44 09 963 / 93160023)
	Renault	Fijac. molduras R-19, Clio II, Kangoo, Laguna, Megane, Scénic, Trafic II (componente del kit Renault Trafic II OEM: 7701 470 769)
162 825	PSA	Fijac. moldura aleta delantera y capó C-15 moderna
162 826	Opel	Fijac. rejilla parabrisas "torpedo" (Eurocode 6300ASCVB)
	Opel	Fijac. tapizados interiores Opel Vivaro
	Renault	Fijac. panel puerta Clio II, Kangoo, Megane, Scénic, fijac. rejilla parabrisas Master '10->, Trafic II
162 827	Renault	Fijac. parabrisas R-21
162 828	Renault	Fijac. moldura techo Clio '98
162 829	Renault	Fijac. rejilla a parachoques Clio '98
162 833	VAG	Fijac. matrícula VW Golf II, Passat, Vento
162 834	VAG	Boca centraje rejilla delantera VW Golf '84-'92
162 835	VAG	Fijac spoiler lateral (bajo puerta) VW Golf III
162 836	VAG	Fijac. pasorueda Audi A2, A4, Q3, Seat Ibiza/Cordoba '02, VW Lupo, Passat, Polo '02, Touareg, fijac. parachoques A3, A4, Q5, Q7, Seat Ibiza/Cordoba '99, León, Toledo, VW Golf IV, New Beetle, fijac. talonera Seat Altea, Toledo '05, fijac. tapizados VW Crafter '06
162 837	VAG	Fij. moldura estribera VW New Beetle, fijac. rejilla delant. a parachoques Polo ->'00, Passat ->'97
162 840	VAG	Fijac. aislamiento capó motor VW Golf III



INDICE REFERENCIAS

FAM. 0300	Marca	Descripción
162 841	VAG	Fijac. elevelunas y varilla apertura puerta VW Golf III, Polo '95
162 842	universal	
162 842	VAG	Fijac. retrovisor exterior a puerta VW Golf III y IV, Polo '95, fijac. panel puerta Skoda Fabia,
	universal	
162 843	VAG	Remache fijac. revestimiento interior maletero Seat Cordoba '97->'09, Ibiza '97->'99, Bora, Golf III, New Beetle, Passat ->'05, Polo '95, fijac. rejilla radiador Seat Leon '99->'05, Toledo '99->'05, fijac. gancho capó Audi A4 '95->'01
	Ford	Botón + boca fijación revestimientos interiores Galaxi
162 844	Opel	Botón + boca fijación junta goma puertas y techo Astra H, Corsa D, Meriva, Zafira A y B
	VAG	Botón + boca fijac. revestimientos contorno puerta VW Golf III
162 845	VAG	Fijac. insonorizantes capó VAG '92-> (largo 20 mm.)
162 846	VAG	Fijac. insonorizantes capó Seat Alhambra, Ibiza/Córdoba '93, Inca, Skoda Octavia '97->'00, VW Caddy, Golf III, Passat ->'97, Polo ->'02, Sharan (largo 30 mm.)
	Ford	Fijac. tapizados puerta Focus, Galaxi, Explorer, Windstar (Eurocode 3550SSCVFDX)
162 847	VAG	Fijac. tapizados puerta, portón trasero y otros usos interiores Audi A3 '97->'03, A6 '98->'09, TT, Seat Alhambra ->'09, Seat Ibiza '97->'99, Córdoba '97->'02, VW Polo Classic '97->'02, Sharan '96->'09, Transporter '97->'03 y '03-> (Eurocode 3550SSCVFDX)
162 848	PSA	Fijac. panel puerta Xantia I y II, ZX
162 849	PSA	Fijac. panel puerta Xantia, ZX
162 850	PSA	Fijac. panel puerta Xantia I y II
	universal	
162 851	Ford	Taco fijac. pasoruada Escort '95, Fiesta '96, Mondeo, fijac. portón trasero Escort, fijac. tapizados Granada, Sierra
	universal	
162 852	Ford	Remache pasoruada Escort '95, Fiesta '96, Mondeo '93-> y '97->
162 853	Opel	Fijac. revestimiento interior traseros Vectra A y B
162 854	VAG	Sujeción radiador VW Caravelle, Transporter '91->'04
162 855	PSA	Fijac. panel puerta Evasion, P-405, P-605, P-806
162 856	PSA	Sujec. cristal Saxo, P-106, P-306
162 857	PSA	Sujec. cristal P-406
162 858	PSA	Fijac. varilla cerradura puerta Peugeot
162 859	PSA	Fij. varilla cerradura puerta AX, C5, C8, XM, ZX, P-106, P-205, P-206, P-306, P-309, P-405, P-406, P-605, P-607, P-807
162 860	Renault	Fijac. varilla cerradura puerta Twingo
162 861	Renault	Fijac. varilla cerradura puerta R-19, Clio, Super-5, Express, Laguna, Safrane, Twingo, Espace, Master, Traffic
162 862	Renault	Fijac. varilla cerradura puerta R-19, Clio, Super-5, Express, Megane, Laguna, Safrane, Twingo, Espace
162 863	Renault	Fijac. varilla cerradura puerta Clio, Megane, Laguna, Safrane
162 864	Renault	Fijac. varilla cerradura puerta Clio
162 865	Renault	Fijac. varilla cerradura puerta Clio
162 866	Renault	Fijac. varilla cerradura puerta Megane
162 867	Renault	Fijac. varilla cerradura puerta Clio, Safrane
162 868	Renault	Fijac. varilla cerradura puerta Clio, Safrane
162 870	Fiat	Fijac. varilla cerr. puerta Ducato, Cinquecento, Cromo, Regata, Uno
162 872	Fiat	Fijac. varilla ceradura puerta Tipo, Tempra, Ducato, A.Romeo - varios -



INDICE REFERENCIAS

FAM. 0300	Marca	Descripción
162 873	Fiat	Fijac. varilla cerradura puerta A.Romeo 147, 156, Punto '99, Multipla
162 874	Opel	Fijac. mando calefacción Ascona, Astra F, Calibra, Omega A, Senator B, Vectra A
162 875	Renault	Fijac. protector pasoruada Megane, Scénic, Laguna
162 876	PSA	Fijac. moldura aletas y panel puerta Evasion, P-106, P-306, P-309 GTI
162 877	VAG	Fijac. tapizados interiores puertas traseras Audi A4 '95->'01, A6 '98->'05
162 879	PSA	Fijac. insonorizantes AX, Berlingo, C8, Xantia, XM, Xsara, ZX, P-106, P-807, Partner
162 880	Fiat	Fijac. gomas puerta y capó Ducato
	PSA	Fijac. gomas puerta y capó Saxo, Xsara, Xantia, Berlingo, Evasión, Peugeot - varios modelos -
162 881	Renault	Fijac. goma capó Laguna, Safrane, y junta puerta delantera Safrane
162 883	universal	
	PSA	Fijac. panel puerta Xantia
162 884	VAG	Fijac. tapizados techo Seat Toledo '92->'99, VW Golf II, Passat ->'93, Transporter '96->'04
162 885	VAG	Fijac. pasoruada A3, A4, Q7, Altea, Arosa, Ibiza/Cordoba, León, Toledo, Caddy '04, Golf III, IV y V, EOS, Lupo, New Beetle, Passat '00, Phaeton, Polo, Scirocco '09, Tiguan, Touran, Transporter
162 886	Fiat	Fijac. elevelunas Fiat Punto
162 887	Fiat	Boca panel puerta y revestimientos interiores Alfa Romeo 147, 156, 159, 166, Fiat Bravo/a, Dobló, Ducato, Marea, Multipla, Punto -todos-, Stilo, Lancia Kappa, Lybra, Y, Ypsilon
	PSA	Boca fijac. tapizados interiores, alfombras piso Boxer / Jumper I y III, Bipper, Nemo
162 888	universal	
	Fiat	Taco revestim. interiores Bravo/a, Dobló, Punto, Tipo, Alfa
	VAG	Fijac. tapizados Seat Cordoba/Ibiza '99->'02, Toledo '92->'99, VW Polo ->'02
162 889	Fiat	Fijac. toma aire Fiat Punto, Punto '99, Lancia Y
162 890	Fiat	Base posicionador parabrisas Fiat Bravo/a, Croma '05, Dobló, Marea, Multipla, Palio, Punto, Stilo, Lancia Y (Eurocode 3354ASCVB)
162 891	Fiat	Fijac. rejilla toma aire a capó Punto '99 y '03 y fij. rejilla parabrisas "torpedo" Ducato '01
	universal	
162 892	Fiat	Taco fijac. toma aire capó y revestimientos interiores Alfa Romeo 147, 156, 159, Mito, Fiat Bravo/a, Dobló, Marea, Punto, Palio, Multipla
	PSA	Fijac. "torpedo" parabrisas y guarnecidos interiores Bipper, Nemo
162 893	Fiat	SopORTE parachoques delantero Bravo/a, Marea (monta con 161.458)
	universal	
162 894	Fiat	Tapón fijac. parachoques delantero y trasero Bravo/a, Marea, Palio
162 895	Fiat	Fijac. toma aire Fiat Bravo/a, Marea, Multipla, Lancia Lybra, fijac. tapiz. interiores traseros Alfa Romeo 159
162 896	Fiat	Fijac. revestimientos interiores Fiat Bravo/a, fijac. junta puerta Fiat Marea
162 897	Fiat	Fijac. cristal posterior a montante puerta y luneta Alfa Romeo 147, Fiat Bravo/a, Multipla, Lancia Y
162 898	Fiat	Fijac. varilla capó Fiat Bravo/a, Marea, Punto, Punto '99 y '03, Palio, Croma, Dobló, Ducato, Lancia Y, Delta, Dedra
162 899	Fiat	Fijac. varilla capó Fiat Bravo/a, Marea
162 900	Fiat	Fijac. cristal lateral Fiat Bravo/a, Marea
162 901	Fiat	Fijac. cristal lateral Fiat Ducato, Tipo, Tempra
	PSA	Fijac. cristal Jumper, Boxer



INDICE REFERENCIAS

FAM. 0300	Marca	Descripción
162 902	universal	
	Fiat	Taco fijac. revestim. interiores y otros usos Fiat Bravo/a, Cromo, Dobló, Marea, Ducato, Stilo, Tipo, Tempra, Uno, Lancia Dedra, Thema
	PSA	Fijac. revestimientos interiores y varios usos Jumper, Boxer
162 903	universal	
	Opel	Taco fijación parrilla radiador Astra H
	Renault	Fijación parachoques Kangoo II, Megane, Scénic, Twingo II, fijac. panel puerta Megane III, otros usos - varios modelos -
162 904	VAG	Fijac. rejilla a parachoques delantero VW Polo '95
162 905	Fiat	Fijac varilla capó Fiat Punto '99, Lancia Y
162 906	universal	
	PSA	Remache fijac. varios usos AX, Berlingo, BX, C2, C3, C3 Picasso, C4, C4 Picasso, C5, C6, Jumpy I y II, Saxo, Xantia, XM, Xsara, P-106, P-206, P-306, P-307, P-308, P-405, P-406, P-407, P-508, P-607, P-806, P-1007, P-3008, P-5008, Expert I y II, Partner
162 907	Fiat	Fijac. moldura cristal Fiat Tipo, Tempra
162 908	universal	
	Fiat	Fijac. aislante capó Alfa 147, 156, 159, Brera, Fiat Bravo/a, Dobló, Marea, Punto '99 y '03, Palio, Lancia Kappa, Lybra, y fijac. revestimientos portón Punto '99
162 909	Fiat	Fijac. radiador Alfa 156, guarnición capó Punto, Bravo/a, Marea, Punto
162 910	universal	
	Ford	Fijac. revestimientos interiores Fiesta, Escort, Transit '94-'00 (color gris claro)
	Nissan	Fijac. revestimientos interiores - varios modelos -
162 911	Fiat	Tapón para toma de aire exterior Alfa Romeo 147, Bravo/a, Marea
162 912	Renault	Tapón agujeros puerta Clio, Megane, Laguna, Master II, Traffic
162 913	Mercedes	Boca fijac. molduras - varios modelos -
162 914	Renault	Fijac. cableado (Ø 6-12) puerta Clio
162 915	Renault	Fijac. cableado (Ø 6-12) puerta Clio, Express, Megane
162 916	Renault	Fijac. cableado (Ø 6-12) capó R-19, R-21, Twingo, Laguna, Traffic
162 918	BMW	Fijac. cableado BMW - varios modelos -
	Ford	Fijac. cableado motor Fiesta, Escort
	Opel	Fijac. cableado Astra F, Calibra, Omega, Senator, Vectra A
162 919	Mercedes	Fijac. moldura parabrisas izquierdo Vito (W638) Clase V (blanca) (Eurocode 5428ASCVS)
162 920	VAG	Fijac. guarnecidos contorno capó motor Audi A1, A4 '08, A5, A6 '11, A7, Q5, Q7, Seat Alhambra '96, Arosa, Skoda Octavia '97, VW Caddy '04 y '11, Golf III, IV, V y VI, Lupo, Polo '95, Sharan, Touran
162 921	BMW	Fijac. pasoruadas, revestimientos y otros usos serie 1 (E87), serie 3 (E90/E91/E92), Z3
	VAG	Fijac. pasoruadas, revestimientos y otros usos - varios modelos -
162 923	VAG	Fijac. pasoruadas, revestimientos y otros usos - varios modelos -
162 924	Mercedes	Fijac. pasoruada, revestimientos y otros usos - varios modelos -
	VAG	Fijac. pasoruadas, parachoques y otros usos Seat Ibiza/Cordoba '93->'02, Inca, León '99->'05, Toledo '99->'05, VW Caddy '96->'03, Polo Classic '96->'02
162 925	universal	



INDICE REFERENCIAS

FAM. 0300	Marca	Descripción
	universal	
162 928	Fiat	Taco fijac. pasoruedas Fiat, Lancia - varios -
	Ford	Taco fijac. pasoruada Fiesta '89
162 929	VAG	Botón fijac. tapizados maletero Seat Ibiza/Córdoba '93, fijac. otros usos Seat Toledo '91->'99
162 930	VAG	Fijac. revestimientos interiores y fijac. placa matrícula VW Golf, Passat, Polo, Transporter, Vento, fijac. rejilla aire VW New Beetle
162 932	Renault	Fijac. rejilla delantera R-19, R-21
	universal	
162 934	Mercedes	Botón fijac. tapizados puerta y portón trasero Vito (W638) y tapizados interiores Vito (W639)
	Nissan	Fijac. tapizados interiores - varios modelos -
	PSA	Fijac. tapizados interiores P-307
	Renault	Fijac. tapizados interiores - varios modelos -
162 935	universal	
	PSA	Fijac. tapizados interiores AX, ZX, Saxo, Xantia, Berlingo, Evasion, P-106, Partner
162 936	PSA	Fijac. junta cristal Saxo, P-106
162 937	Opel	Fijac. moldura parabrisas Astra G (parte delantera) (Eurocode 6284ASCHS)
162 938	Opel	Fijac. moldura techo-parabrisas (parte delantera y final) Astra G (Eurocode 6284ASCH1T)
162 940	universal	
162 941	Dacia	Botón fijac. pasoruada Logan
	Ford	Fijac. tapizados interiores -varios modelos-
	PSA	Fijac. tapizados interiores Xantia I y II, ZX, P-407
	Renault	Fij. tapizados interiores R-19, R-21, R-25, Super-5, Express, Twingo, Clio I y III, Laguna I y II, Safrane, Master, Traffic
162 942	PSA	Fijac. insonorizantes interiores Saxo, P-306
162 943	BMW	Fijac. molduras serie 3 (E36 y E46)
162 944	BMW	Fijac. molduras serie 5 (E39) y serie 7 (E38)
	Fiat	Fijac. moldura lateral Fiat Multipla
	Opel	Fijac. molduras laterales traseras Astra '98, 3 puertas
162 945	BMW	Fijac. parabrisas serie 5 ->'95 (E34) y serie 7 ->'94 (E32) (Eurocode 2426/2427ASCS)
162 946	VAG	Fijac. tapizados panel puerta Seat Ibiza/Cordoba '02->'08, León '99->'05, Toledo '99->'05, VW Golf IV '98->'04, Passat '97->'05 (Eurocode 8556LSCSFD)
162 947	Honda	Fijac. molduras parabrisas Concerto SJ4 '91->'95 (Eurocode 3943ASCHB)
	Rover	Fijac. moldura parabrisas Rover 200/400 (Eurocode 7016ASCHB)
162 948	BMW	Fijac. revestimientos s.3 (E36 y E46), s.7 (E65, E66, E67 y E68), X3 (E83 y E83N), X5 (E53) y Z4
	Ford	Fijac. revestimientos (tornillo Ø 6) -varios modelos-
	Mini	Fijac. parachoques trasero y revestimientos int. R50, R52, R53 y R56
	Opel	Fijac. (tornillo Ø 6) aleta delantera Corsa B, Omega, Vectra A, fijac. bajos carrocería Corsa A
	VAG	Fijac. revestimientos (tornillo Ø 6) - varios modelos -
162 949	Ford	Fijac. moldura guardabarros Fiesta '89 (tornillo Ø 3,9)
162 950	Ford	Fijac. revestimientos parachoques Ka
162 951	Ford	Boca fijac. revestimientos parachoques Ka (monta en 162.950)



INDICE REFERENCIAS

FAM. 0300	Marca	Descripción
162 952	Ford	Fijac. varilla capó Fiesta '96
162 953	Ford	Fijac. revestimientos interiores Fiesta '89 y '96
	Mercedes	Fijac. tapizados y panel puerta - varios modelos -
162 954	Ford	Fijac. revestimientos interiores Fiesta '89 y '96
162 955	universal	
	Ford	Fijac. pasoruada Ka, Fiesta'89, Fiesta'96, Granada, Puma, Escort, Mondeo, fijac. moldura exterior Escort, fijac. rejilla Mondeo '96-'00, fijac. tapizados interiores Mondeo '00->'07
162 956	Ford	Fijac. pasoruada Fiesta '89
162 957	universal	
	Ford	Fijac. pasoruada Fiesta '96, Focus, C-Max, Mondeo '00-'07, y parachoques delantero Focus '05, C-Max, fijac. parachoques trasero Fiesta '02-'08, Mondeo '07, fijac. deflector aire Kuga '08
162 958	universal	
	Ford	Fijac. revestimiento portón trasero Escort '97, Fiesta '89 y Fiesta '96
162 959	universal	
	Ford	Fijac. aislante capó y revestimientos interiores Ka
162 960	Volvo	Remache fijac. junta puerta delantera XC90 '03->
	Ford	Fijac. tapizados interiores Escort '91-> y '97-> (color negro)
162 961	Renault	Fijac. panel puerta Megane, Clio'98, Kangoo, fijac. otros usos Laguna I, Megane II, Trafic I
162 962	Renault	Fijac. molduras puertas Clio II, Kangoo, Megane, Megane II Coupé, Scenic III, Vel Satis
162 963	universal	
	Ford	Fijac. intermitente del. a parachoques Focus '98, fijac. panel puerta delantero Transit '00-'06 (monta con 164.685)
162 964	Fiat	Fijac. molduras puerta Fiat Ulisse
	PSA	Fijac. moldura puerta P-806, Citroen Evasión
162 965	Fiat	Base posicionador parabrisas Alfa Romeo 147, Mito, Fiat 500 '07, Bravo/a, Marea, Panda 2004, Punto'99 y '03 y Evo, Grande Punto '05, Lancia Ypsilon (Eurocode 3359ASCH6B)
	PSA	Base soporte parabrisas "torpedo" Nemo, Bipper
162 966	Fiat	Fijac. panel puerta y revest. interiores Fiat Punto '99 y '03, Lancia Ypsilon
162 967	PSA	Fijac. rejilla parabrisas "torpedo" P-206 (Eurocode 6539ASCHB)
	PSA	Fijac. aletas y moldura puerta Berlingo '09, C2, C3 Picasso y Pluriel, Evasion, Jumpy I y II, P-207, P-306, P-307, P-308, P-806, P-1007, Partner '09, Expert I y II, fijac. talonera puerta P-3008, fijac. parrilla radiador Saxo, fijac. tapizados P-508
	PSA	Fijac. panel puerta P-206 y fijac. tapizados maletero P-508
	Renault	Fijac. molduras laterales Fluence, Megane III, Twingo II
162 968	universal	
	Opel	Botón fijac. tapizados interiores (color negro)
162 969	VAG	Soporte lateral parachoques Seat Alhambra, Ibiza '93-'97, VW Golf II y III, Sharan, Passat -> '97
162 970	Opel	Fijac. aislante capó Agila, Astra F, G y H, Corsa A, B, C y D, Kadett, Meriva, Omega, Signum, Vectra A, B y C, Zafira
162 971	Ford	Fijac. varilla puerta C-Max, Escort '95, Fiesta ->'08, Focus '98 y '05->, Puma, S-Max '06->, Transit Connect '02
162 972	Ford	Fijac. cableado puerta Escort, Fiesta ->'02, Focus '98->'04, Galaxy, Mondeo '93->'07, Transit
162 973	Ford	Fijac. panel puerta Focus '98
162 974	Opel	Fijac. placas matrículas Opel Astra F, Calibra, Kadett, Omega, Senator
162 975	universal	
	Renault	Fijac. aislante capó Renault - varios -, fij. alfombra Clio II y III



INDICE REFERENCIAS

FAM. 0300	Marca	Descripción
162 976	Fiat	Fijac. panel puerta Fiat Punto '99 y '03, fijac. panel maletero Fiat Stilo '01 (monta con 162.977)
162 977	Fiat	Boca fij. panel puerta y tapizados Fiat Punto '99 y '03 (monta con 162.976)
162 978	PSA	Fijac. parrilla lavaparabrisas "torpedo" Xsara I y II (Eurocode 2725ASCHB)
	PSA	Fijac. revestimientos interiores puerta AX, Evasion, Expert I y II, P-806 (monta con 162.446)
162 979	universal	
	Fiat	Fijac. guardabarros Fiat Ulysse, Lancia Phedra
	PSA	Fij. pasoruada, insonoriz. capó y rejilla calandra C8, Jumpy, P-206, P-307, P-807, Expert, fijac. panel puerta, tapizados, parachoques, bajos carrocería C3 '10->, C3 Picasso, C4, C4 Picasso, C8, DS3, Jumpy III, Xsara, P-106, P-207, P-306, P-307, P-308, P-406, P-807, P-3008, P-5008, Expert III, fij. capó Berlingo/Partner '09->, C5 '08, Evasion, P-407, P-806
162 980	PSA	Fijac. tapizados interiores P-106, P-206, P-307, fijac. tapizados portón trasero C4 Picasso, fijac. rejilla calandra C8
162 981	PSA	Fijac. panel puerta P-406
162 982	PSA	Fijac. varios usos Berlingo, Jumpy I y II, Xantia, Xsara I y II, Xsara Picasso, P-306, P-406, P-607, P-806, Expert, Partner
162 983	PSA	Fijac. varilla cerradura Xsara I y II
162 984	PSA	Fijación rejilla de calandra Berlingo, C4, Evasion, Jumpy I y II, Xantia II, Partner, P-306, P-806, Expert I y II
162 985	universal	
	PSA	Fijac. panel puerta Jumpy III, Expert III, fijac. aletas P-206, P-406, fijac. parachoque trasero P-407
162 987	PSA	Fijac. panel puerta Xsara I y II
162 988	PSA	Fijac. panel puerta Xsara I y II
162 989	PSA	Fijac. panel puerta Xsara I y II
162 990	VAG	Fijac. moldura lateral parabrisas Seat Toledo '99->'05, León '99->'05 (Eurocode 7608ASCSS)
162 991	VAG	Fijac. moldura lateral parabrisas Seat Toledo '99->'05, León '99->'05 (Eurocode 7608ASCSS1B)
162 992	Fiat	Fijac. moldura Iveco Daily
	Opel	Fijac. moldura lateral Vivaro
	Renault	Fijac. molduras Kangoo, Master
162 993	Fiat	Fijac. moldura Iveco Daily
	Opel	Fijac. moldura lateral Vivaro (componente del kit Opel Vivaro OEM: 44 09 963 / 93160023)
	Renault	Fijac. molduras Kangoo, Master, Trafic II, fijac. panel portón trasero Kangoo (componente del kit OEM: 7701 470 769)
162 994	Opel	Fijac. moldura lateral Vivaro (componente del kit OEM: 44 09 963 / 93160023)
	Renault	Fijac. molduras Kangoo, Master, Trafic II (componente del kit Renault Trafic II OEM: 7701 470 769)
162 995	Renault	Fijac. molduras laterales Kangoo
162 996	Renault	Fijac. molduras Clio II, Kangoo II, Laguna II, Megane, Scénic RX4
162 997	Renault	Fijac. molduras Espace IV
162 998	Renault	Fijac. guarnecidos interiores Clio II, Megane I
162 999	Renault	Fijac. parabrisas Clio II ('98->), Clio III ('05->), Kangoo, Laguna II ('01->), Master III '10->, Megane I, Megane II, Scenic II (Eurocode 7248ASCH)
163 000	VAG	Soporte parachoques delantero derecho Seat Córdoba '97, Ibiza '97
163 001	VAG	Soporte parachoques delantero izquierdo Seat Córdoba '97, Ibiza '97
163 002	VAG	Tensor para kit reparación elevalunas Seat Ibiza, León/Toledo '99, VW Golf IV '98->'04,
163 003	VAG	Kit reparación elevalunas VW Golf IV
163 004	VAG	Kit reparación faro derecho VW Golf IV '98->'04
163 005	VAG	Kit reparación faro izquierdo VW Golf IV '98->'04



INDICE REFERENCIAS

FAM. 0300	Marca	Descripción
163 006	universal	
	Dacia	Fijac. insonorizante capó y fijac. alfombras Logan, Sandero, Duster
163 007	Renault	Fijac. pasoruada Laguna II y III, Latitude, fijac. tapiz. alfombras piso Clio IV, Latitude, Megane III, Scenic III, fijac. insonoriz. capó Clio III, Megane II y III, Scenic II y III, Master III
	universal	
163 008	Renault	Fijac. insonorizante capó Laguna II (negra)
	universal	
	Dacia	Fijac. pasoruada y protector parachoques delantero Logan, Sandero, Duster, Lodgy
163 009	Renault	Soporte cristal elevalunas delantero derecho Master
	Renault	Fijac. pasoruada Captur, Clio II, III y IV, Espace IV, Kangoo I y II, Laguna I, II y III, Latitude, Megane I, II y III, Master II y III, Modus, Scenic I, II y III, Twingo I y II, fijac. alfombras Laguna II y III, Megane II y III, Scenic II y III
163 011	universal	
	Fiat	Fijac. revestimientos interiores Iveco Daily, Lancia Lybra
163 012	Renault	Soporte cristal elevalunas delantero izquierdo Master
	Fiat	Fijac. molduras Iveco Daily
163 013	Chevrolet	Fijac. tapizados interiores Caprice, Nexia, Pontiac
	Opel	Fijac. panel puerta Astra H, Corsa C, Corsa D '07->, Meriva A '03->, Zafira B '05->
163 014	Fiat	Fijac. tapizados interiores -varios modelos-
	Ford	Fijac. panel puerta Ka, Focus, Fiesta,'96, Puma
163 015	universal	
	Mercedes	Fijac. rejilla lavaparabrisas "torpedo" Vito (W639) y otros usos Mercedes CL, SL
	PSA	Remache fijac. rejilla calandra P-306, P-406, fij. tapiz. maletero Jumpy I y II, Xsara II, P-307, P-308, Expert I y II, fijac. toma aire rejilla parabrisas P-206 (Eurocode 6539ASSHB)
163 016	VAG	Remache fijac. varios usos VW Golf, Jetta'97
163 017	PSA	Fijac. rejilla de calandra delantera (bajo faro) P-306 restyling
163 018	Ford	Fijac. varilla capó Fiesta '96, Focus, Ka, Mondeo, Transit
163 019	PSA	Fijac. insonorizante capó Berlingo, C2, C3, C3 Picasso y Pluriel, C5 '01->'04, Saxo, Xantia, XM, Xsara I y II, Xsara Picasso, P-206, P-207, P-1007, Partner, Ranch
163 020	Ford	Fijac. rejilla parabrisas "torpedo" Focus '98->'04 (Eurocode 3556ASCHB)
163 021	Renault	Fijac. óptica Megane I (hasta ->03/'99)
	universal	
163 022	VAG	Fijac. rejilla parabrisas "torpedo" Seat Ibiza/Cordoba '93->'99, Inca '96->'04, VW Caddy'96->'03
163 023	Ford	Fijac. moldura parabrisas Transit IV '00-> (Eurocode 3739ASCV1)
163 024	Ford	Fijac. moldura parabrisas Transit IV '00-> (Eurocode 3739ASCV)
163 025	Ford	Tapón parrilla lavaparabr. Escort '97, Mondeo '93 y '97, Transit (Eurocode 3546ASSH/ASCHB1B)
163 026	Fiat	Fijac. cristal lateral Alfa Romeo 156, 159, Fiat Grande Punto '05->
163 027	VAG	Kit reparación elevalunas Seat Ibiza, León/Toledo '99->'04, Skoda Fabia, VW New Beetle
163 028	VAG	Kit reparación elevalunas Seat Arosa, Ibiza/Cordoba '93->'01, VW Lupo, Polo '94->'99
163 029	VAG	Kit reparación elevalunas izquierdo Audi A4 ->'02, Skoda Superb, VW Passat '97, Polo '99->'01
163 030	VAG	Kit reparación elevalunas derecho Audi A4 ->'02, Skoda Superb, VW Passat '97, Polo '99->'01
163 031	VAG	Kit reparación elevalunas Skoda Octavia
163 032	VAG	Tensor para kit reparación elevalunas Skoda Octavia



INDICE REFERENCIAS

FAM. 0300	Marca	Descripción
163 032	PSA	Fijac. tapa motor Berlingo, C4, C5, Xantia, Xsara, Xsara Picasso, P-206, P-306, P-307, P-406, P-607, Partner
		universal
163 035	Honda	Fijac. pasoruada Accord '90-'97, Balade, Civic ->'00, Concerto, CRX ->'91, Integra, Legend, Prelude '90->'95, NSX
	Rover	Fijac. pasoruada Rover 400
		universal
163 036	Honda	Fijac. parrilla parabrisas Accord '90-'00, Civic, Legend '96-'00 (Eurocode 3936ASCHB / 7020ASCSS4B)
	Rover	Fijac. parrilla parabrisas Rover 400 '95->, Rover 600 (Eurocode 3936ASCHB/7020ASCSS4B)
		universal
163 037	BMW	Fijac. bajos carroceria serie 1 (E81, E82 y E88)
	Chevrolet	Fijac. parachoques Aveo, Matiz, Nubira, Pontiac
	Honda	Fijac. revestimiento parachoques Accord '92->'97, Civic '01-'02, Concerto, CRX, Legend ->'95, Prelude ->'96
	Mini	Fijac. pasoruada y talonera puerta R50, R52, R53, R55, R56, R57 y R60
	Rover	Fij. parachoques Rover 25, fijac. pasoruada Rover 75, fijac. revestimiento parachoques Rover 400
163 038	VAG	Fijac. matrícula Seat Ibiza/Cordoba '93, Toledo '92, VW Golf III y IV, Polo Classic '96, Passat '92
163 039	Opel	Fijac. revestimientos parachoques Astra F, G y H, Corsa B, Calibra, Omega, Signum, Vectra B y C, Zafira A
163 042	Renault	Fijac. monograma Clio II, Scenic II
163 043	Renault	Fijac. paneles portón posterior y montantes cinturón seguridad Kangoo, fijac. tapizados interiores Clio II, Trafic II
		universal
163 044	BMW	Fijac. revest. interiores y parachoques - varios modelos -
	Mercedes	Fijac. pasoruada Sprinter '06 y otros usos clase C (W203), clase E (W211)
	Mini	Fijac. revest. interiores R50, R52, R53 y R56
	Rover	Fijac. rejilla calandra Range Rover '02->'09
	Smart	Fijac. talonera puerta Smart ForTwo
	VAG	Remache fijac. parrilla radiador Seat Alhambra '96->'00, Toledo '13, VW Sharan '96->'00, y fijac. tapizados interiores Audi A3 '13, A8 '10, Q5
		universal
163 045	BMW	Fijac. parachoques serie 3 (E46), s.5 (E39), s.7 (E38), X3 (E83/83N), X5 (E53), Z3 y Z4
	Mini	Fijac. revest. interiores R50, R52, R53 y R56
		universal
163 046	BMW	Fijac. parachoques serie 3 (E36, E46), s.5 (E34, E39), s.7 (E38), X3 (E83/83N), X5 (E53), Z3 y Z8
		universal
163 047	BMW	Fijac. parachoques serie 3 (E30, E36, E46) , serie 5 (E39, E60), s.7 (E38), X5 (E53)
	Opel	Fijac. parachoques trasero Astra H, Combo, Meriva, Insignia, fijac. parachoques delantero Astra F
		universal
163 048	Opel	Fijac. parachoques delantero y trasero Astra G y H, Corsa C, Meriva A y B, Signum, Tigra, Vectra B y C, Zafira A y B
163 049	VAG	Fijac. parrilla delantera VW Lupo
163 050	VAG	Fijac. guarnecido contorno capó motor VW Polo
		universal
163 051	VAG	Fijac. tapizados interiores Audi 80, 100, A2, A4, A6, Seat Ibiza '02, VW Passat, fij. talonera puerta VW Passat '97->'05, fijac. pasoruada Seat Altea, Toledo '05
163 052	Fiat	Fijac. moldura lateral Fiat Ducato '01->
	PSA	Fijac. moldura lateral Jumper II y III, Peugeot Boxer II y III



INDICE REFERENCIAS

FAM. 0300	Marca	Descripción
163 053	Fiat	Fijac. cristal lateral Alfa Romeo 147, Fiat Dobló, Punto '03->
	universal	
163 054	Opel	Fijac. parachoques, pasoruada y spoiler Astra H, Signum, Vectra C, Zafira A y B, fijac. revestim. interiores Astra G y H, Corsa D '07->
163 055	BMW	Fijación elevalunas serie 3 (E36 y E92), serie 5 (E34), Z3, Z4 (Eurocode 2431LSGSFD)
163 056	universal	
	BMW	Fijación rejilla lavaparabrisas serie 5 (E34), serie 7 (E32), Z1 (Eurocode 2427ASCSB)
163 057	Mercedes	Fijac. varilla capó ML
	Opel	Fijac. varilla capó Astra G, Calibra, Corsa'94, Omega A, Vectra A
163 058	BMW	Fijac. moldura cristal serie 7 ->'01 (E38) (Eurocode 2433ASCS)
163 059	BMW	Fijac. panel puerta serie 3 (E36 y E46), serie 5 (E34 y E39), serie 7 (E38), X5 (E53), Z3 y Z8
163 060	BMW	Fijac. panel puerta serie 5 (E39)
163 061	BMW	Fijac. tapizados interiores serie 3 (E36), serie 5 (E34 y E39), s.7 (E32)
163 062	BMW	Fijac. varilla puerta serie 3 (E36), serie 5 (E34 y E39), serie 7 (E32 y E38) y Z3
	universal	
163 063	BMW	Taco para fijac. tornillo Ø 3,5 serie 5 (E34)
	Mercedes	Taco para tornillo Ø 3,5 fijac. rejilla lavaparabrisas "torpedo" Vito (W638), Clase V y otros modelos
163 064	Opel	Fijac. panel puerta Astra F, Vectra C
163 065	Opel	Fijac. moldura lateral puerta, talonera puerta y aletas Astra G, Corsa B, Signum, Vectra B y C, Zafira A
163 066	Opel	Fijac. tapizados interiores Astra F, G y H, Calibra, Kadett, Omega, Vectra A y B, Zafira B
163 067	VAG	Fijac. varilla puerta Audi 100, A3 ->'03, A4 ->'01, A6 ->'97, Seat Arosa, Ibiza/Cordoba '97->'99, Leon '99->'05, Toledo '99->'05, VW Caddy '04, Golf ->'05, Lupo, Passat ->'97, Polo ->'02, Transporter '91->'03
163 068	universal	
	BMW	Fijac. rápida - varios usos - serie 3 (E30), serie 5 (E28)
163 069	universal	
	BMW	Fijac. torpedo parabrisas S.5 '10-> (F10/11/18), S.6 (F06/12/13)
	BMW	Fijac. rápida - varios usos - varios modelos
	Mercedes	Remache fijac. parachoques trasero Vito (W639), fijac. moldura lateral parte posterior Sprinter, fijac. tapizados interiores clase C (W203), otros usos CLK, ML, clase S
	Mini	Fijac. parachoques delantero R56
	Mitsubishi	Fijac. varios usos y modelos
	VAG	Remache fijac. tapizados maletero Audi A3 '13, TT, VW New Beetle '12
	Volvo	Remache fijac. cubrecárter y bajos carrocería S40/V40 '00->'04 y otros usos V70, XC70
163 070	universal	
	BMW	Fijac. rápida - varios usos - serie 3 (E30, E34), serie 5 (E39), serie 7 (E32, E38, E65,66,67,68), Z3
163 071	VAG	Fijac. manecilla respaldo VW Golf IV, Polo, Passat
163 072	VAG	Fijac. tapizados interiores Seat Arosa, VW Lupo, Polo '95
163 073	VAG	Fijac. tapizados interiores VW Caddy '04 y '11, Transporter T4 y T5, LT
163 074	universal	
	Mercedes	Remache fijac. tapizados interiores clase E (W212), y otros usos varios modelos
	VAG	Remache fijac. insonoriz. A2 '00->'05, fijac. cubierta parachoques Q7, fijac. tapizados interiores A8
163 075	VAG	Fijac. anagramas Audi A4



INDICE REFERENCIAS

FAM. 0300	Marca	Descripción
163 076	VAG	Fijac. tapa interior retrovisor Seat Altea, Arosa, Toledo '05->, VW Golf IV, Lupo, Polo, Touran
163 077	BMW	Fijac. cierre rápido BMW - todos los modelos -
163 078	BMW	Fijac. rejilla radiador serie 3 (E36), serie 5 (E34), serie 7 (E38) (Eurocode 2431ASCSB7B)
163 079	universal	
	Opel	Tapón agujeros Ø 6,5 Ascona, Astra F y G, Calibra, Corsa A, Kadett, Omega, Senator
163 081	PSA	Fijac. gomas puerta y capó C8, Xsara I y II, Xsara Picasso, P-406, P-807
	Renault	Fijac. gomas puerta y capó Kangoo, Laguna, Master
163 082	Dacia	Fijac. panel puerta Logan
	PSA	Fijac. mold. lateral parabrisas C3 Pluriel (Euroc. 2730ASCTS1B)
	PSA	Fijac. panel y revestimientos puerta Berlingo, C2, C3, C4, C4 Picasso, C5 '01->'08, C6, C8, Xsara Picasso, P-206, P-207, P-306, P-307, P-308, P-406, P-407, P-607, P-807, P-1007, Partner, fijac. aletas P-206, P-207
	Renault	Fijac. panel puerta Clio III, Kangoo, Scenic II y RX4, Vel Satis, fijac. parachoques trasero Megane II, fijac. panel puerta y embellecedor exterior Espace IV
	VAG	Fijac. tapizados posteriores Audi A4 '01->'08
	Volvo	Remache fijac. moldura puerta S40 '08->, V50, fij. talonera puerta C30, S40 '08->, V50, V70 '08->, XC70 '08->
163 083	Fiat	Fijac. panel puerta Fiat Ulisse
	PSA	Fijac. panel puerta y tapizados C2, C4 Picasso, C8, Jumpy III, P-207, P-407, P-807, Expert III, fijac. aletas delanteras Berlingo '09, Jumpy III, Partner '09, Expert III, fij. parachoque trasero C3 Picasso
	Renault	Fij. moldura lateral Espace IV, Kangoo II, Megane III, Master '10->, Zoé, fijac. moldura portón trasero Symbol / Thalia, fijac. otros usos Modus, Vel Satis
	Renault	Fij. panel puerta y rejilla delantera Megane II, Scenic II, Twingo II, fijac. tapiz. interiores Clio II, Scenic II, Megane III, fijac panel puerta, tapizados y alerón Clio III, fijac. rejilla delantera a faro Kangoo
163 084	PSA	Fijac. varilla apertura puerta Berlingo, C5 ->'08, C8, Jumpy I y II, Xantia, Xsara Picasso, P-206, P-306 restyling, P-807, Expert I y II, Partner
163 085	universal	
	Opel	Fijac. panel trasero Corsa D, Vectra C
163 086	PSA	Remache fijac. pasoruada, moldura inferior puerta y tapizados C2, C3 ->'10, C4 Picasso, C5 ->'07, C6, P-1007, P-308 '14->, P-407, fijac. rejilla calandra y soporte parachoques Jumpy, Expert I, II y III
	universal	
163 088	PSA	Fijac. revestimientos interiores y tapizados puerta Berlingo, Jumpy, Saxo, P-1007, P-106, P-205, P-306, P-806, Expert -todos-, Partner
	universal	
	Dacia	Fijac. rejilla calandra y protector parachoques delantero Duster, Logan y Sandero, fij. parachoque trasero Lodgy
	Nissan	Fijac. parachoques Micra
	Opel	Fijac. rejilla calandra Opel Movano B, fijac. soporte bandeja trasera Vivaro
163 089	Renault	Fij. aletas y rejilla calandra Clio III, Espace IV, Fluence, Laguna III, fijac. pasoruada y parachoques Clio III, Kangoo II, Laguna III, Megane II, Scenic II, fijac. tapizados interiores Clio II, Espace IV, Laguna II, Vel Satis
	VAG	Fijac. panel puerta Seat Ibiza/Córdoba '99->'02, VW Touareg
163 090	Ford	Fijac. panel puerta Fiesta '02, Fusion



INDICE REFERENCIAS

FAM. 0300	Marca	Descripción
163 091	universal	
	Chrysler	Fijac. parachoques delantero y parrilla radiador Chrysler PT Cruiser, Dodge Journey '11->, Neon, Nitro, Jeep Grand Cherokee '05->'10, Commander '06->, Wrangler '07->
	Ford	Fijac. rejilla lavaparabrisas "torpedo" Fiesta '02, Fusion, fij. parachoques delantero Mondeo '96-'00
	Opel	Fijac. parachoque delantero Antara '12->
	Renault	Remache fijac. revestimientos interiores Scenic
	Rover	Fijac. aletas y pasoruada Evoque, fij. pasoruada Discovery '05->'09 y Range Rover
	VAG	Fij. bajos carrocería A4 '01->, A5, A6 '05->, Q5, TT, Golf 5, Passat, Touran, fij. pasoruada A3 '04->, fij. conducto aire parach. Ibiza / Córdoba '02->, Leon '05, fij. suspensión Audi A3 '04->, Seat Altea, Leon/Toledo '05, Octavia '04, Superb, Golf V y VI, Passat '05, Tiguan, Touran
163 092	Renault	Fijac. tapizados portón trasero Espace III
163 093	Fiat	Fijac. spoiler bajo puerta Fiat Punto '99 y '03, y Punto EVO, Stilo '01, fij. panel puerta Fiat Croma, Lancia Thema
163 094	Fiat	Fijac. tapizados interiores Alfa Romeo 156, Fiat Punto '99->'03, Lancia Thesis
163 095	Fiat	Fijac. faros delanteros Fiat Dobló, Alfa Romeo 156, fijac. rejilla radiador Fiat Croma, Lancia Delta, Alfa 33 y fijac. tapizados interiores Barchetta, Cinquecento, Marea, Marengo
163 096	Fiat	Fijac. tapizados interiores y rejilla radiador Alfa Romeo 145, 146, 156 y fijac. parachoques delantero Alfa Romeo 156
	PSA	Fijac. rejilla radiador Boxer / Jumper III '06->
163 097	Fiat	Fijación parrilla radiador Fiat 500 '07->, fijación spoiler bajo puerta Alfa Romeo 156, 164 y fijac. tapizados interiores Barchetta, Alfa Romeo 145, 146, 147, 156, 164, 166
163 098	Fiat	Fijac. moldura lateral Fiat Dobló
163 099	universal	
	Fiat	Fijac. pasoruada Fiat Stilo
163 100	Mercedes	Fijac. moldura lateral (parte delantera) Clase C (W202, W208), Clase E (W210)
163 101	Mercedes	Fijac. moldura lateral (parte derecha trasera) Clase C (W202)
163 102	Mercedes	Fijac. moldura lateral (parte izquierda trasera) Clase C (W202)
163 103	Mercedes	Fijac. moldura lateral (parte trasera) Clase C (W202) (monta junto con 163101 y 163102)
163 103	VAG	Fijac. moldura lateral Audi A8
163 104	VAG	Fijac. tapizados interiores VW Golf '98->'04, Bora, Lupo, Passat '97->'05
163 105	VAG	Fij. tapizados interiores Audi A6, 80/100/200, Seat Alhambra '96->'09, VW Sharan '96->'09, Transporter '91->'09
163 106	VAG	Fijac. tapizados interiores Audi A6, A8, 80, 100
163 107	VAG	Fijac. tapizados interiores Seat León '99->'05, Toledo '99->'05, VW Bora, Golf IV
163 108	VAG	Fijac. tapizados bajo cristal trasero y alfombras Seat Alhambra, VW Passat, Sharan
163 109	VAG	Remache fijac. parachoques delantero Audi A3 '97->'03
163 110	BMW	Fijac. moldura talonera serie 3 (E36 y E46)
163 111	VAG	Kit reparación elevallas Audi A2
163 112	VAG	Kit reparación elevallas Audi A3, A6
163 113	VAG	Kit reparación elevallas Audi A4 '01->'08, Seat Exeo
163 115	Renault	Fijac. tapizados interiores Master II
	VAG	Fijac. tapizados interiores VW Transporter
163 116	VAG	Fijac. revestimientos interiores de montantes laterales Seat Ibiza/Córdoba '02->'09, Inca '99->'01, León '99->'05, Toledo '99->'05, Skoda Octavia '97->'09, Superb, VW Bora, Golf IV, New Beetle, Passat '97->'05, Polo '95->'02
163 117	VAG	Fijac. panel puerta Audi A2, A4 '03->'09, Seat León '99->'05, Toledo '99->'05, Ibiza/Córdoba '02->'08, VW Passat '97->'05, Golf IV



INDICE REFERENCIAS

FAM. 0300	Marca	Descripción
163 118	Fiat	Kit reparación faro derecho Punto '99->'03
163 119	Fiat	Kit reparación faro izquierdo Punto '99->'03
163 120	Nissan	Taco fijac. aletas Nissan Terrano II '96-> y varios usos otros modelos
163 121	Toyota	Fijac. pasoruada Toyota Celica, Corolla, Corona Land Cruiser ->'89
163 122	Toyota	Fijac. "torpedo" parabrisas Toyota Auris, y fij. juntas puertas Auris, Avensis, Celica, Corolla, IQ, Prius, Starlet, Yaris
163 123	Honda	Fijac. moldura parabrisas Civic '91->, Integra (Eurocode 3940/3948ASCS)
	Rover	Fijac. moldura parabrisas Rover 400, 45, MG ZS (Eurocode 3940/3948ASCS/ASCCTS7B)
163 124	Honda	Fijac. parrilla parabrisas Ballade, City, Civic '92->'00 (3 y 5 puertas), CRV '97->'01, CRX, HRV, Integra, Logo (Eurocode 3948ASCC)
	universal	
163 125	BMW	Fijac. torpedo parabrisas serie 3 (E36), s.7 (E38), Z3 (Eurocode 2431/2433/2435ASCSB)
	BMW	Fijac. torpedo parabrisas BMW serie 3 (E36), s.7 (E38), Z3 (Eurocode 2431/2433/2435ASCSB)
163 126	Renault	Fijac. soporte faro delantero Laguna II
163 127	universal	
	PSA	Remache fijac. pasoruada trasero, bajos carrocería y tapa motor C4, C5 '01->'07, P-307, P-607, fijac. parachoques y tapizados interiores C4 Picasso, C6, C8, P-3008, P-807, fijac. pasoruada C3 ('01->'04), P-207, P-406 restyling,
163 128	universal	
	BMW	Fijac. torpedo parabrisas serie 5 (E39), X5 (E53) (Eurocode 2434ASSH y 2434/2426ASCSB)
	BMW	Fijac. torpedo parabrisas BMW serie 5 (E39), X5 (E53) (Eurocode 2434ASSH y 2434/2426ASCSB)
163 129	universal	
	Ford	Fijac. tapizados interiores e insonorizante capó Transit '06
	VAG	Fijac. tapizados interiores (parte inferior trasera) Audi A4 '01->'05, A8, Seat Altea, Ibiza/Cordoba '93->'02, Inca, Leon '99->'05 y '05->, Toledo I, II y III, VW Caddy '96->'03, Golf II, Passat ->'97
163 130	Toyota	Fijac. moldura parabrisas Toyota Camry '91->'96, Carina ->'92 (Eurocode 8262ASCH)
163 131	Honda	Fijac. moldura parabrisas Civic '91->, Integra Coupe '93->'98 (Eurocode 3954ASCH)
	Rover	Fijac. moldura parabrisas Rover 400, 45 y MG ZS (Eurocode 3954ASCH)
163 132	Honda	Fijac. moldura parabrisas Accord '90->'93 (Eurocode 3936ASCSS6B)
	Rover	Fijac. moldura parabrisas Rover 600 (Eurocode 3936ASCSS6B)
163 133	Ford	Base soporte parabrisas Fiesta '02->, Galaxy '94->'98, Ka, Mondeo '93->'96 (Eurocode 3554ASCH)
163 134	VAG	Fijac. tapizados interiores pilar A, VW Polo '02->'09
163 135	Ford	Fijac. juntas estanqueidad Ford Fiesta '02, Fusion
	PSA	Fijac. junta puerta P-307, P-607
	Renault	Fijac. juntas estanqueidad Laguna, Kangoo, Master
163 136	PSA	Fijac. tapizados portón trasero C5 '01->'04, Xsara Picasso
163 137	Renault	Fijac. aletas delanteras Clio II
163 138	Renault	Fijac. varilla capó Clio II
163 139	Renault	Fijac. tapizados portón trasero Scenic I



INDICE REFERENCIAS

FAM. 0300	Marca	Descripción
163 140		universal
	Dacia	Fijac. pasoruada Sandero
	Fiat	Remache fijac. rejilla parabrisas "torpedo" Fiat 500 '07, Croma '05->
	Fiat	Remache fijac. rejilla parabrisas "torpedo" Fiat 500 '07, Croma '05->
	Opel	Fijac. rejilla parabrisas "torpedo" Vivaro (Eurocode 6300ASCVBK)
163 141	Renault	Remache fijac. rejilla calandra Clio III, Laguna III, Latitude, Trafic II, fijac. pasoruada Megane II, fijac. moldura superior aleta Twingo II, fijac. tapiz. interiores Renault varios modelos
	Opel	Fijac. panel puerta y tapizados interiores Movano, Vivaro
	Renault	Fijac. panel puerta y tapizados interiores Espace IV, Laguna II, Trafic II
163 142	Rover	Fijac. moldura inferior puerta Discovery 3 y 4 '05->, Evoque, Freelander y Range Rover '02->
	Renault	Fijac. moldura rejilla parabrisas Twingo II '07->, fijac. molduras laterales Scenic RX4, fijac. tapizados interiores Laguna II, Megane CC, Modus, Scenic RX4, Vel Satis
163 143	Renault	Fijac. junta capó Espace IV, Vel Satis
163 144	Renault	Fijac. bandas laterales Scenic RX4
163 145	Renault	Fijac. tapizados portón trasero Laguna II, Espace IV
163 146	Renault	Fijac. anagramas Espace IV, Laguna II, Megane II
163 147	VAG	Fijac. moldura bajo puerta (talonera) Audi A3
163 148	VAG	Fijac. moldura bajo puerta (talonera) Audi A4
163 149	Opel	Fijac. moldura lateral puerta Astra G ('98->'03), 3 y 5 puertas
163 150	Opel	Fijación (tornillo Ø 5) guardabarros y pasoruada Astra G, Corsa B y C, Meriva, Zafira B, y fijac. tapizados interiores Astra G y H, Corsa B y C, Combo, Meriva, Omega, Tigra, Zafira
163 151	VAG	Fijac. tapizados puerta Seat Arosa, VW Lupo
163 152	VAG	Fijac. panel puerta Seat Arosa, VW Lupo
163 153	BMW	Fijac. spoiler delantero serie 3 (E30)
163 154	VAG	Fijac. panel puerta Audi A4 '01->'08
163 155	Nissan	Clip fijac. parrilla radiador - varios modelos -
163 156	Nissan	Clip fijac. molduras pasoruada Patrol, Terrano, Terrano II, fijac. molduras laterales Terrano II, fijac. revest. portón trasero Almera Tino, Terrano II
163 157	Nissan	Clip fijac. parachoques Serena
163 158	Nissan	Clip fijac. parrilla radiador Almera, Micra, Primera, Terrano II
163 159	Honda	Clip fijac. parrilla radiador - varios modelos -
	Mazda	Clip fijac. parrilla radiador - varios modelos -
	Opel	Clip fijac. parrilla radiador Campo, Frontera, Monterrey
	Toyota	Fijac. parrilla radiador Celica, Corolla, HiLux, Land Cruiser ->'01
163 160	Lexus	Clip fijac. moldura pasoruada RX300 '00->'03
	Toyota	Fij. moldura pasoruada Camry, Carina, Celica ->'99, Corolla ->'97, MR2, Previa, Tercel
163 161	Lexus	Clip fijac. revestimientos interiores LS430, RX300
	Mitsubishi	Fijac. tapizados interiores Colt, Outlander, Space Star, Montero/Pajero '06->
	PSA	Fijac. panel puerta C1, P-107
	Subaru	Fijac. tapizados interiores - varios modelos -
	Suzuki	Fijac. panel puerta Swift, SX4 '06->
	Toyota	Fijac. tapizados interiores Avensis, Auris, Aygo, Camry, Celica, Corolla, Hilux, IQ, Land Cruiser, MR2, Previa, Rav4, Verso, Yaris



INDICE REFERENCIAS

FAM. 0300	Marca	Descripción
163 162	Lexus	Clip fijac. spoiler y protección lado puerta RX300
	Toyota	Fijac. moldura base retrovisor y talonera puerta Aygo, Avensis '03, Corolla '01, Yaris '99->'05 y '05->, fijac. aletas y moldura portón trasero Rav 4 '05->, fijac. tapiz. interiores Celica, HiAce
163 163	universal	
	Chevrolet	Fijac. parachoques Aveo, Captiva, Equinox, Leganza, Nubira, Pontiac
	Honda	Fijac. parachoques Accord '92-'97 y otros modelos
163 164	universal	
	Honda	Fijac. parachoques Accord '97->, Civic '97->, CRV '97->, Jazz '05->, Odyssey '96->, FRV, HRV, Insight, Integra, Legend, NSX, fijac. talonera puerta CR-V
163 165	universal	
	Lexus	Fijac. pasoruada RX270/350/450H, RX300, RX400H
	PSA	Fijac. pasoruada delantero C1 '14->, P-108
	Toyota	Fijac. pasoruada y parachoques Auris, Aygo '14->, Corolla, IQ, Prius '09->, Yaris
163 166	universal	
	Lexus	Fijac. parachoques IS200/300 '99->'05
	Nissan	Fijac. parachoques y otros usos Almera Tino, Note, Primera, Teana, Tiida, X-Trail
	PSA	Remache fijac. superior parachoques delantero C1, P-107
163 167	Toyota	Fijac. parachoques Previa, Starlet, Verso, Yaris, fijac. pasoruada Verso, HiLux '97->'05, fijac. portón trasero Rav4 '00, fijac. spoiler parachoques delantero Celica '99->'05, Corolla '97->'01, fijac. parrilla radiador Aygo, Yaris Verso
	universal	
	Lexus	Fij. mold. pasoruada IS200/300 '99->'05, IS250/350 '05, LS430, fij. bajos carrocería IS250C, GS300
163 168	PSA	Remache fijac. spoiler trasero C1, P-107
	Toyota	Fij. moldura pasoruada Avensis Verso ->'09, Camry '06, Corolla '97->'06, Corolla Verso '09, Picnic, Previa, Starlet, Yaris '99-> y '05->, Yaris Verso, HiAce, fijac. spoiler trasero Aygo
163 169	universal	
	Honda	Fijac. revestimientos interiores - varios modelos -, fij. "torpedo" parabrisas Prelude ->'91 (Eurocode 3931ASCHB)
163 170	universal	
	Honda	Fijac. revestimientos interiores y talonera puerta Civic'92->'00, CRV '00->'01, Integra, Legend, Odyssey '01->'04, Prelude '83->'87
163 171	Rover	Fijac. talonera puerta Rover 45
	Honda	Fijac. rejilla entrada de aire Civic '92->'00, CRV '97->'01, Odyssey
163 172	universal	
	Ford	Fijac. parachoques delantero Mondeo '07->, fijac. aleta y talonera puerta Kuga '08, C-Max '11->, Focus '11->
	Honda	Fijac. pasoruada Accord '96->, Civic '96->'06 y '06->, CRV '97->, HRV, Insight, Jazz '07
163 173	Mitsubishi	Fijac. parachoque y pasoruada ASX '10, Grandis, Lancer, L200, Outlander '06, Montero/Pajero '06
	universal	
163 174	Honda	Fijac. revestimientos interiores Accord, Civic, CRX, Integra, Legend, Logo, NSX, Odyssey, Prelude
	Mazda	Fijac. varios usos Mazda 323, 626 Wagon
163 175	universal	
	Honda	Fijac. revestimientos interiores - varios modelos -
163 176	universal	
	Honda	Fijac. varios usos Accord '99->'02, Prelude '89->'91
163 177	VAG	Fijac. varilla capó Audi 80, 90, 100, Coupé, Seat Altea, Arosa, Córdoba/Ibiza '93->'08 y '08->, Inca, Leon '05->, Toledo '92->'09, VW Caddy ->'03, Golf ->'92, LT ->'96, Polo, Transporter '91->'03 y '03->



INDICE REFERENCIAS

FAM. 0300	Marca	Descripción
163 176	PSA	Fijac. cristal lateral puerta trasera C5 '01->'08
	VAG	Fij. cristal lateral puerta trasera Seat Altea, Ibiza/Cordoba '02->'09, Leon '99->'05, Toledo '99->'09, Skoda Fabia '00->'09, Octavia '04->'08, Roomster, Superb, VW Bora, Golf IV y V, Passat '97->, Polo '95->'02 y '02->'09, Tiguan, Touran
163 177	VAG	Fijac. revestimientos interiores Seat Alhambra '03->'09, Ibiza/Cordoba '02->'09, Leon '05->, VW Sharan '03->'09, y fijac. revestimientos techo Córdoba '99->'02, Polo Classic '00->'02
163 178	VAG	Fijac. recubrimiento puerta delantera Bora, Golf IV y V, Scirocco '09, fijac. panel puerta A4, Arosa, Caddy '04, Lupo, Passat '97->, fijac. tapizados interiores Phaeton, fijac. tapizados portón A5, fijac. moldura pasoruada Golf Plus, parachoques trasero A6, Altea, Ibiza/Cordoba '02, Polo '02->, fijac. panel puerta, moldura pasoruada y techo Q7, Touareg, Touran, Transporter
163 179	PSA	Fijac. junta portón trasero Jumper / Boxer I, II y III, fijac. moldura vierteaguas y fieltro capó P-307, P-406
163 180	universal	
	Ford	Taco fijacion faro Focus '98-'04, Fiesta '02->'08, Sierra
	Ford	Taco fijacion faro Focus
163 181	universal	
	VAG	Fijac. carcasa pasoruada interior Audi 100, A4, A6, VW Bora, Golf IV
163 182	Renault	Fijac. junta goma puerta Clio IV, Megane II
163 183	VAG	Tapón panel puerta Seat Ibiza/Córdoba, VW Polo '95
163 184	VAG	Soporte delantero estribera Seat Ibiza/Córdoba '95, Inca'98, VW Caddy '98, Polo '96, Polo '00
163 185	VAG	Soporte central estribera Seat Ibiza/Córdoba '95, Inca'98, VW Caddy '98, Polo '96, Polo '00
163 186	VAG	Soporte trasero estribera Seat Ibiza/Córdoba '95, Inca'98, VW Caddy '98, Polo '96, Polo '00
163 187	VAG	Fijac. embellecedor parrilla radiador Seat Ibiza/Córdoba'95, Inca '98
163 188	VAG	Fijac. panel puerta y revestimientos interiores Audi 100, 200, A2, A3 '97->'03 y '03->, A4 '95->'08, A6 '95->'09, A8
163 189	VAG	Tapón aisladores acústicos Audi A3 '97->'03, TT '99->'06, VW Bora, Golf IV, Polo '02
163 190	VAG	Tapón desagüe (19,80) Audi A2, A3, A4, A5, A6, Q5, Seat Altea, Ibiza/Cordoba '99->'02, León '99->'05 y '05->, Toledo '99->'09, VW Caddy '04, Golf IV y V, Bora, New Beetle, Passat '97->'05, Scirocco '09, Tiguan, Touran
163 191	Honda	Fijac. panel puerta y otros usos Civic '96->'05, Odyssey '99->'04
163 192	universal	
	Honda	Fijac. varios usos Civic, Prelude
163 193	Lexus	Fijac. insonorizante capó IS200/300, LS400/430, RX300 '00->'03, SC430
	Toyota	Fijac. insonorizante capó Corolla '97->'06, Land Cruiser Prado '02->'09, Previa, Supra, Verso, Yaris '99->'05 y fijac alfombras Celica '99->'05
163 194	Toyota	Fijac. insonorizante capó Land Cruiser
163 198	universal	
	Mercedes	Remache fijac. varios usos y modelos
	Opel	Fijac. varios usos Opel Frontera, Euromidi
	Volvo	Fij. rejilla parabrisas "torpedo" S40 '04, S60 '01, V50, V70/XC70, XC90 (Eurocode 8828ASCSB) fijac. spoiler S40 '04, V50, fijac. deflector puerta XC60, fijac. parachoques 740, 760
163 199	Volvo	Fijac. moldura lateral parabrisas S60 '01->'09, V70 '00->'08, V70XC ->'07 (Eurocode 8829ASCES1B)
163 200	PSA	Soporte tapa motor Berlingo, C4, C5, Xantia, Xsara, Xsara Picasso, P-206, P-306, P-307, P-406, P-607, Partner
163 201	universal	
	PSA	Fijac. pasoruada P-306, fijac. tapizados P-307, P-308, fij. insonorizante tablero C4, P-106, fijac. luna puerta C4 '11->
163 202	Renault	Soporte parachoques delantero Laguna II y III (lado derecho)



INDICE REFERENCIAS

FAM. 0300	Marca	Descripción
163 203	Renault	Soporte parachoques delantero Laguna II y III (lado izquierdo)
163 204	VAG	Fijac. revestimientos laterales Seat Ibiza/Córdoba '02->'09, León '02->'05, Toledo '02->'05
163 205	VAG	Fijac. alfombras piso y revestimientos interiores VW New Beetle '06->, Golf IV
	universal	
163 206	VAG	Fijac. juntas estanqueidad puertas Audi 80, 100, A3, A4, A6, A8, New Beetle Cabrio, fijac. tapizados interiores León '99->'05, Toledo '99->'05
163 207	VAG	Fijac. tejadillo VW Golf IV '98->'02
163 208	VAG	Tapón desagüe (29,60) Audi A2, A3, A4, A5, A6, A8, Q5, Q7, TT, Seat Ibiza / Cordoba '99, Leon / Toledo '99->'05, Skoda Superb '02, VW Golf IV, New Beetle, Polo Classic '00->'02
163 209	VAG	Fijac. revestimientos montante pilar A, Passat '88->'97
	universal	
163 210	VAG	Fijac. revestim. interiores Seat Arosa, León '99, Toledo '99, Skoda Octavia '97, VW Golf, Lupo, New Beetle, Polo '00->
	universal	
163 211	VAG	Fijac. parachoques VW Passat '88->'93, fijac. soporte placa matricula VW Golf III - y varios usos -
163 212	VAG	Fijac. panel puerta Audi A3 '03-> (2 puertas), TT '07->, R8
163 213	VAG	Fijac. moldura guía puerta corredera VW Caddy '04 y '11, Transporter '03->
163 214	Renault	Fijac. (con inserto tornillo Ø6) rejilla radiador y otros usos R-21, R-25, Super-5, Express, Master, Trafic, Kangoo
163 215	Renault	Fijac. (con inserto tornillo Ø6) rejilla radiador y otros usos R-21, R-25, Super-5, Express, Master, Megane, Laguna
	universal	
163 216	Fiat	Fijac.pasoruada y revestimientos interiores Alfa Romeo 159, Brera, Fiat Bravo/a, Idea, Punto '99 y '03, Stilo, Lancia Kappa, Lybra
163 218	Fiat	Boca fijac.panel puerta Fiat Idea
	universal	
163 219	Fiat	Taco fijac.revestimientos interiores Fiat Bravo/a, Coupe, Marea, Punto '03, fijac. panel puerta Palio, Dedra, Nuevo Delta
163 220	Fiat	Fijac.varilla capó Fiat Panda 2003
163 221	Fiat	Fijac.revestimientos interiores Alfa Romeo 147, Fiat Idea, Punto EVO
	universal	
	Dacia	Taco fijac. revestimientos interiores Logan
	Fiat	Taco fijac. revestimientos interiores Iveco Daily
	Opel	Taco fijac. aleta y moldura lateral puerta Opel Movano
163 222	PSA	Fijac. revestim. interiores Berlingo '09, C3, C3 Picasso, C4, C4 Picasso, C5 '08->, DS3, Evasion, Jumpy I, II y III, Xantia, Xsara, Xsara Picasso, P-206, P-207, P-308, P-806, P-5008, Expert I, II y III, Partner '09, fijac. rejilla lavaparabrisas Berlingo, C5 '01->'08, Jumpy III, Expert III, Partner, fijac. parachoques Berlingo '09, C2, C3, DS3, Evasion, P-207, P-308, P-806, P-1007, Partner '09,
	Renault	Taco fijac. revestimientos interiores - varios modelos -
163 223	Renault	Fijac. varilla capó Clio III, Laguna II, Megane II, Scenic II
163 224	Renault	Fijac. varilla capó Clio III, Laguna II, Megane II, Modus, Scenic II
	Renault	Fijac. junta goma puerta Captur, Megane II y III
163 225	Volvo	Remache fijac. junta goma puerta C70 '06->
163 226	Renault	Remache fijac. portón trasero puerta Clio II, Clio III, Laguna, Megane II, Scenic II
163 227	VAG	Tapón protector motor/cárter - varios modelos -



INDICE REFERENCIAS

FAM. 0300	Marca	Descripción
163 228	VAG	Tuerca protector motor/cárter - varios modelos -
163 229	VAG	Tuerca fijac. bajos Audi A3, VW Polo ->'02, Golf IV, Golf V
163 230	Ford	Fijac. tapizados Galaxi
	VAG	Fij. tapizados Seat Alhambra '96->'09, Altea, Leon '05->, Toledo '05->, VW Sharan '96->'09, Touareg, Transporter T5
163 231	Ford	Fijac. juntas estanqueidad puerta Galaxy
	VAG	Fijac. juntas estanqueidad puertas Seat Alhambra, VW Sharan
163 232	VAG	Boquilla moldura vierteaguas Audi A4 '01->'08, A6 '05->
163 233	Ford	Clip fijacion varilla capó Escort, Fiesta ->'02, Ka, Transit ->'00
163 234	PSA	Fijac. tapizados portón P-307, fijac. tapizados interiores P-307, P-607, fijac. capó P-607, fijac. caja corrector faros C4 universal
163 235	Mercedes	Remache fij. pasoruada clase C (W204), CLK (W209), clase E (W212), ML (W164), fij. parachoque clase A (W169), clase B (W245), fij. talonera puerta ML, GL, W164
	Opel	Fijac. varios usos - varios modelos -
	VAG	Remache fijac. varios usos - varios modelos -
163 236	VAG	Kit reparación faro derecho VW Polo '02->'05
163 237	VAG	Kit reparación faro izquierdo VW Polo '02->'05
163 238	VAG	Kit reparación faro derecho VW Lupo '99->'06
163 239	VAG	Kit reparación faro izquierdo VW Lupo '99->'06
163 240	VAG	Kit reparación faro derecho Audi A4 '01->'05
163 241	VAG	Kit reparación faro izquierdo Audi A4 '01->'05
163 242	VAG	Kit reparación faro derecho e izquierdo Audi A3 '97->'03
163 243	VAG	Kit reparación elevallas izquierdo Seat Córdoba Vario, Ibiza '02->, VW Polo Classic, Variant
163 244	VAG	Fijac. panel puerta y revestimientos interiores Seat Ibiza '93->'99, Córdoba '93->'02, Inca '96->'03, VW Caddy '96->'03, Polo Classic/Variant '96->'02
163 245	VAG	Fijac. panel puerta y revestimientos interiores Seat Ibiza/Córdoba, '93->'99, Inca, VW Caddy ->'03, Polo '96->'02
163 246	Toyota	Fijac. parrilla radiador Rav 4 '00->'05
163 247	Toyota	Fijac. moldura pasoruada trasero Rav 4 '00->'05
163 248	Fiat	Fijac. rejilla parabrisas "torpedo" Sedici '06-> (Eurocode 3363ASCR)
	Suzuki	Fijación rejilla parabrisas "torpedo" SX4 '06->, fijac. moldura puerta Grand Vitara (Eurocode 3363ASCR)
	Toyota	Fijac. parachoques y portón trasero Rav 4 '94->'05, fijac. portón trasero Yaris Verso '99->'05
163 249	universal	
	Lexus	Fijac. moldura pasoruada LX470
	Toyota	Fij. moldura pasoruada Rav 4 '00->'05, Land Cruiser '96->'07, fij. rejilla radiador Avensis Verso '01
163 250	Lexus	Fijac. panel puerta y tapizados interiores LS400, RX300 '00->'03
	Suzuki	Fijac. panel puerta y tapizados interiores - varios modelos -
	Toyota	Fijac. panel puerta y tapizados interiores Camry, Carina, Celica ->'99, Corolla ->'06, Hi-Lux, HiAce, Land Cruiser ->'07, Paseo, Previa, Prius '00->'03, Starlet, Yaris '99->'05, 4Runner
163 251	Lexus	Fijac. moldura portón trasero IS200/300, GS300/430
	Toyota	Fijac. moldura portón trasero Avensis '03->'08, Corolla '97->'07, Corolla Verso ->'09
163 252	Toyota	Fijac. tapizados alfombras Yaris '99->'05, Verso
163 253	Toyota	Fijac. panel puerta Carina E, Corolla ->'01, Corolla Verso '01->'03, Yaris '99->'05
163 254	Toyota	Fijac. revestimientos interiores Avensis '03->'08, IQ, Paseo, Verso-S, Yaris



INDICE REFERENCIAS

FAM. 0300	Marca	Descripción
163 255	Toyota	Fijac. tapizados portón trasero Land Cruiser ->'07 y otros usos - varios modelos -
	universal	
163 256	Toyota	Fijac. pasoruada trasero Aygo, Corolla, Prius, Verso-S, Yaris, fij. talonera puerta Celica, Corolla '01
	universal	
163 257	Toyota	Fijac. aislamiento capó Cressida, Hi-Lux
163 258	Lexus	Fijac. aislamiento capó IS250/350, IS F, IS250C, GS30/35/43, GS300/450, LS430/460/600, LX470/570, GX460, RX300/350/400H/450H
	PSA	Fijac. aislamiento capó Citroën C1, Peugeot 107
	Toyota	Fijac. aislamiento capó Auris, Avensis '03->'08, Aygo, Camry, Corolla, IQ '08, HiAce, HiLux, Land Cruiser, Prius, Rav4 '05->, Verso, Yaris '05->
163 259	Lexus	Fijación goma capó CT200H, IS250C, IS F, GS30/35/43, GS300/450, LS400/430/460/600, RX300/330/350/400/450H
	Toyota	Fijac. goma capó Avensis Verso, Camry, Carina E, Celica, Corolla, Cressida, MR2, Picnic, Prius, Starlet, Verso, Yaris
163 260	Toyota	Fijac. goma capó Camry, Celica, Corolla, Land Cruiser ->'01, Starlet
	universal	
163 261	Toyota	Fijac. varios usos - varios modelos -
	universal	
163 262	Toyota	Fijac. varios usos - varios modelos -
163 263	Dahiatu	Fijac. moldura pasoruada Feroza, Terios
163 264	Dahiatu	Fijac. parrilla radiador Feroza, Terios
163 265	Dahiatu	Fijac. bisagra puerta Feroza, Terios
163 266	Hyundai	Fijac. moldura lateral puerta Hyundai Elantra, fij. parrilla radiador Hyundai Sonata
163 267	Mitsubishi	Fijac. moldura pasoruada Pajero, Montero
163 268	Mitsubishi	Taco fijac. tapizados y varios usos Mitsubishi - varios modelos -
	Nissan	Fijac. tapizados y varios usos Nissan Micra, Montero, Pajero, Space Runner, Sunny
	universal	
163 269	Mitsubishi	Fijac. parachoques, moldura pasoruada y tapizados Carisma, Colt, Galant, Space Runner
	universal	
163 270	Mitsubishi	Fijac. parrilla radiador y moldura pasoruada Carisma '95->'03, Colt '04->, Space Star '98->'04
	universal	
163 271	Mitsubishi	Fijac. parrilla radiador, moldura pasoruada, parachoques Colt Lancer, Montero, Pajero
163 272	Mitsubishi	Fijac. tapizados Carisma, Colt Lancer, Space Runner
163 273	Mitsubishi	Fijac. moldura parabrisas Montero, Pajero
	universal	
163 274	Mitsubishi	Taco fijac. tapizados Mitsubishi - varios modelos -
	universal	
163 275	Mazda	Fijación parachoque trasero, panel puerta y tapizados Mazda 2, 3, 5, 6, 121, 323, 626, Demio, MX3, MX5, RX8
	universal	
163 276	Nissan	Fijac. bajos carrocería Qashqai, fijac. parachoques - varios modelos -
	Subaru	Fijac. pasoruada y otros usos Impreza
163 277	universal	
	Honda	Fijac. parachoques, molduras pasoruada y tapizados interiores Accord ->'07, Civic 26101->, CRV 26102->'06, Jazz
	Nissan	Fijac. parachoques, molduras pasoruada y tapizados interiores Almera, Almera Tino, Micra '03->, Primera '90->'02, Serena, Sunny, Terrano II
	Volvo	Remache fijac. parachoques S40 '04->, S60 '01->, S80 '99->'06 y '07->, V50, XC60, XC70, C30, C70 '06, fijac. otros usos XC90, fijac. rejilla parabrisas "torpedo" XC60 '10->



INDICE REFERENCIAS

FAM. 0300	Marca	Descripción
163 278	universal	
	Nissan	Fijac. parachoques, molduras pasoruada y parrilla radiador Galant, Micra, Montero, Pajero, Space Runner, Sunny
163 279	Nissan	Clip fijac. parrilla radiador Micra, Primera
163 280	Nissan	Fijac. tapizados interiores - varios modelos -
163 281	universal	
	Honda	Fijac. revestimientos interiores, pasoruada y otros usos Accord, Civic, CRV, Legend, NSX, Prelude
	Hyundai	Fijac. parachoques Accent, Santa Fe, Tucson, Sorento, Sportage, fijac. revestimientos interiores Coupé, Elantra, Sonata
163 282	Mercedes	Fijac. panel puerta - varios modelos -
163 283	Mercedes	Fijac. estribera bajo puerta Serie C 200
163 284	Mercedes	Boca fijac. molduras Mercedes 210
163 285	Mercedes	Fijac. moldura lateral - varios modelos -
163 286	Mercedes	Fijac. moldura lateral (124)
163 287	Mercedes	Fijac. pasoruadas, revestimientos y otros usos - varios modelos -
163 288	BMW	Fijac. pasoruadas y revestim. serie 1 (E87), serie 3 (E36, E46, E90, E91, E92), serie 5 (E34, E39, E60, E61), serie 7 (E65, E66, E67, E68), X3, X5 (E53)
	Mercedes	Fijac. pasoruadas, revestim. y otros usos - varios modelos -
	Mini	Fijac. parachoques trasero R50, R52, R53 y R56
163 289	BMW	Fijac. molduras serie 3 (E36)
163 290	BMW	Boca fijac. molduras serie 3 (E36 y E46), serie 5 (E39), serie 7 (E38)
163 291	BMW	Fij. rejilla lavaparabr. s.3 (E36), s.5 (E34/39/60/61), s.6 (E63, E64), s.7 (E38/65/66/67/68), X5 (E53)
163 292	BMW	Fijac. molduras serie 5 (518, 520, 524, 525, 528, 535, M5), 630, 635
163 293	Chevrolet	Fijac. tapizados Matiz - y otros -
163 294	Honda	Fijac. revestimientos interiores, junta capó y junta puerta Accord ->'89, Civic ->'91, CRX ->'91, NSX '97->'01, Prelude
163 295	universal	
	Toyota	Fijac. rejilla radiador Yaris '99->'05
163 296	universal	
	Lexus	Fijac. parachoques LS400, SC430
	Toyota	Fijac. parachoques Avensis ->'02, Carina, Celica, Corolla '92->'07, Corolla Verso ->'09
163 297	universal	
	Lexus	Fijac. tubo inyección gasolina IS200/300
	Toyota	Fijac. protectores de parachoques y pasoruada Land Cruiser '96->'02 y '02->'09
163 298	universal	
	Ford	Taco fijac. revestimientos interiores Mondeo '94-'00 y '00-'07
163 299	universal	
	Fiat	Remache fijac. revestimientos interiores Fiat Scudo, Ulysse '01, Lancia Phedra (negra)
	PSA	Remache fijac. revestimientos interiores Jumpy (negra)



INDICE REFERENCIAS

FAM. 0300	Marca	Descripción
163 300	universal	
	Mitsubishi	Fijac. varios usos y modelos
	PSA	Remache fijac. rejilla parabrisas "torpedo" C1 '14->, P-108
	PSA	Remache fijac. rejilla parabrisas "torpedo" C1 '14->, P-108
	Subaru	Fijac. rejilla parabrisas "torpedo" Justy II
	Suzuki	Fijac. rejilla parabrisas "torpedo" Swift (Eurocode 8011ASCH / 8010ASCR)
	Suzuki	Fijac. rejilla parabrisas "torpedo" Swift y otros usos - varios modelos -
	Toyota	Fijac. rejilla parabrisas "torpedo" Aygo '14->
	Toyota	Fijac. rejilla parabrisas "torpedo," Aygo '14->, varios usos HiLux, MR2
	Volvo	Remache fijac. rejilla parabrisas "torpedo" C30, C70, S40 '04->, V50 '04-> (Eurocode 8011ASCH)
163 301	universal	
	Suzuki	Fijac. tapizados interiores - varios modelos -
163 302	universal	
	Suzuki	Fijac. tapizados interiores - varios modelos -
163 303	universal	
	Fiat	Remache fijac. revestimientos interiores Fiat Scudo, Ulysse '01, Lancia Phedra (gris)
	PSA	Remache fijac. parachoques trasero P-307, tapiz. interiores puertas Jumpy I y II, Expert I y II (gris)
163 304	universal	
	Volvo	Remache fijac. moldura talonera puerta S40 '04, S60 '01->'09, V50, V70 '00->'07, C30, fijac. tapizados puerta C70, fijac. parachoques C70, V70 '97->'04
163 305	universal	
	Mercedes	Remache fijac. varios usos y modelos
	Opel	Fijac. parachoques Astra G, Omega B, Vectra B, Zafira A, fijac. bajos carrocería Corsa A, Vectra A
	VAG	Remache fijac. parachoques VW LT '04->'07
	Volvo	Remache fijac. parachoques y moldura exterior S40 / V40 '00->'04
163 306	universal	
	Ford	Fijac. moldura lateral Fiesta '02, fijac. moldura inferior puerta Focus '08, fijac. tapizados interiores Kuga '08
	Renault	Remache fijac. varios usos
	VAG	Fijac. parachoques y bajo capó Audi 80, 100, 200, A6, bajos carrocería A8 '03->
163 307	universal	
	Chevrolet	Fijac. tapizados y pasoruada Aveo, Kalos, Lanos, Pontiac
	Opel	Fijac. moldura pasoruada Astra H, Corsa B, C y D, Calibra, Meriva A y B, Signum, Tigra B, Zafira B
163 308	universal	
	PSA	Fijac. aletas delanteras AX, BX, C-15, Saxo, Xantia, P-106, fij. aletas traseras P-106, P-206, P-406, fijac. revestimientos interiores AX, C-15, Berlingo, Xantia, XM, Xsara I y II, ZX, P-306, Partner, fijac. deflector P-306, y fijac. capó C4, C8, Jumpy III, ZX, P-106, P-306, P-307, P-807, Expert III
163 309	PSA	Fijac. moldura lateral C4, Jumpy III, Expert III, fijac. panel puerta Expert III, Jumpy III, fij. deflector trasero (alerón) C4
163 310	Renault	Base soporte parabrisas Clio I (incluye adhesivo) (Eurocode 7231ASFH/7232ASCH)
163 311	VAG	Kit reparación elevallunas derecho Seat Córdoba Vario, Ibiza '02->, VW Polo Classic, Variant
163 312	PSA	Fijac. moldura lateral parabrisas C2 (Eurocode 2731ASCHS)
163 313	PSA	Fijac. moldura lateral parabrisas P-308, P-407 (Eurocode 6544ASCSS)
163 314	PSA	Fijac. inferior moldura lateral parabrisas P-407 (Eurocode 6544ASCSS1B)
163 315	PSA	Fijac. superior moldura lateral parabrisas P-407 (Eurocode 6544ASCSS2B)



INDICE REFERENCIAS

FAM. 0300	Marca	Descripción
163 316	PSA	Base soporte parabrisas Berlingo, C4, Xantia, Xsara Picasso, ZX, Partner (Eurocode 2719ASCH)
	universal	
163 317	PSA	Fij. refuerzo parachoques delantero C5, C6, P-407, fijac. parachoques trasero P-407, fijac. revestim. interiores Jumpy III, Expert III
163 318	PSA	Fijac. varilla cerradura Berlingo, Xantia, P-306, Partner
	Renault	Fijac. varilla cerradura puerta Kangoo
163 319	VAG	Tapón fijac. protector motor/cárter - varios modelos -
163 320	Dacia	Fijac. insonorizantes y pasoruada Logan, Sandero, Duster y Lodgy
	Renault	Fijac. insonorizantes y pasoruada Clio III, Laguna II y III, Latitude, Megane III, Modus, Scenic II y III, Twingo II
163 321	Renault	Base soporte parabrisas R-19 (incluye adhesivo) (Eurocode 7236ASFH)
163 322	PSA	Fijac. varilla cerradura C5 '01->'08, Xsara Picasso, P-206, P-306, P-406,
163 323	PSA	Fijac. varilla capó Xsara Picasso
163 324	Renault	Fijac. frontales y pasoruada Megane II
163 325	Renault	Fijac. gomas puerta y capó Clio III, Trafic II
163 326	PSA	Fijac. portón trasero y retrovisor C5 '01->'08, fijac. aletas delanteras ZX, fijac. otros usos Berlingo, C4 '11->, P-308
	universal	
163 327	Renault	Fijac. insonorizante capó Laguna II y III, Master, Vel Satis
	universal	
163 328	Renault	Remache fijac. rejilla calandra y tapizados interiores Trafic II, fijac. moldura portón Espace IV
	universal	
163 329	Nissan	Remache fijación varios usos
	VAG	Remache fijac. tapizados interiores Seat León '99->'05, Toledo '92->'99 y '99->'05
163 332	Opel	Fijac. moldura pasoruada delantero Corsa C y Combo
163 333	Rover	Fijación moldura parabrisas Range Rover '95 y 2000 New Style (Eurocode 7024ASCR)
163 334	Volvo	Fijac. moldura lateral parabrisas S60 '01->'09, V70 '00->'08, V70XC ->'07 (Eurocode 8829ASCSS / 8829ASCES)
163 335	Volvo	Fijac. moldura superior parabrisas S40 / V40 '96->'04 (Eurocode 8824ASCST)
163 336	Volvo	Fijac. moldura lateral parabrisas S40 / V40 '96->'04 (Eurocode 8824ASCSS / 8824ASC6B)
163 337	Volvo	Fijac. moldura lateral parabrisas S40 / V40 '96->'04 (Eurocode 8824ASC57B / ASCES)
163 338	Renault	Fijac. moldura techo Kangoo
163 339	Smart	Fijac. parachoques Smart ForTwo
163 340	Renault	Fijac. derecha rejilla delantera a faro Megane I
163 341	Renault	Fijac. izquierda rejilla delantera a faro Megane I
163 342	Renault	Fijac. derecha rejilla delantera a faro Scenic I
163 343	Renault	Fijac. izquierda rejilla delantera a faro Scenic I
	universal	
	Fiat	Remache fijac. rejilla parabrisas "torpedo" Alfa Romeo Giulietta
	Fiat	Remache fijac. talonera puerta, rejilla parabrisas y tapizados interiores Alfa Romeo Giulietta
163 344	PSA	Remache fijac. pasoruada, parachoques, tapa motor y bajos carrocería Berlingo '08->, C3 '10->, C3 Picasso, C4 '04->'10 y '11->, C5 '08->, C6, P-206, P-207, P-307, P-308, P-508, P-3008, P-5008, Partner '09->, fij. tapiz. interiores, porton trasero y tapa motor C4 Picasso, Jumpy III, Expert III, P-308 '14->, fijac. bajos carrocería C5 '05->'08, P-308 '14->, P-407,



INDICE REFERENCIAS

FAM. 0300	Marca	Descripción
163 345	Opel	Fijac. molduras laterales parabrisas Zafira A '99->'04 (Eurocode 6283ASCH / 6283ASCVS)
163 346	VAG	Fijac. juntas estanqueidad puertas Seat Ibiza/Córdoba '02->
163 347	BMW	Fijac. moldura parabrisas serie 3 '04-> (E90/E91) (Eurocode 2447ASCSS)
163 348	BMW	Fijac. moldura derecha parabrisas serie 3 '04-> (E90/E91) (Eurocode 2447ASCSS1B)
163 349	BMW	Fijac. moldura izquierda parabrisas serie 3 '04-> (E90/E91) (Eurocode 2447ASCSS2B)
163 350	universal	
	BMW	Fijac. revestimientos maletero serie 3 (E91) y serie 5 (F07)
	VAG	Fijac. tapizados puerta VAG - varios modelos -
163 351	Ford	Taco fijac. protectores motor Escort, Mondeo, Puma, fijac. parachoques Mondeo '96->'00, Fiesta '08->, fijac. columna dirección Fiesta '08, fijac. deflector interior Mondeo '00-'07
163 352	Toyota	Soporte faro delantero derecho Yaris '99->'05
163 353	Toyota	Soporte faro delantero izquierdo Yaris '99->'05
163 354	Toyota	Fijac. panel puerta Yaris '99->'05, Picnic, fijac. tapizados interiores Corolla '01, Avensis Verso '01, Land Cruiser
163 355	Toyota	Fijac. junta gomas puerta Yaris '99->'05 y '05->, Yaris Verso, HiLux '05->, Urban Cruiser '09, fijac. parrilla radiador Corolla Verso '04->'09
163 356	Lexus	Fijac. tapizados asientos LS430 '00->'06
	Toyota	Fijac. tapizados portón trasero Yaris
163 357	Toyota	Fijac. aislamientos capó Celica ->'99, Rav4 '00->'05
163 358	universal	
	Lexus	Fijac. parachoques y rejilla radiador IS250/350 '05->, IS250C '09->, IS F '08->
	PSA	Remache fij. parachoques trasero C1, P-107, fij. guardabarros pasoruada y rejilla delantera P-108, C1 '14->
	Toyota	Fijac. parachoques delantero y trasero y rejilla radiador Auris, Avensis '08->, Camry '96->'01, Celica, Corolla '01->'06 y '06->, IQ '08, Prius, '00->'09 y '09->, Verso-S '10->, Yaris '99->'05 y '05->, Yaris Verso, fijac. parachoques trasero Avensis '97->'08, Aygo, Urban Cruiser '09
163 359	Lexus	Fijac. moldura parabrisas GS300, GX460, LS430, LS460, LS600H, LX570 (Eurocode 8310ASCH)
	Toyota	Fijac. moldura parabrisas Toyota Avensis '03->'08, Aygo, Camry, Celica, Corolla '01->'06, IQ, Land Cruiser, Prius, Rav 4 '00 y '05, Yaris '99 y '05-> (Eurocode 8310ASCH)
163 360	Volvo	Fijac. moldura parabrisas 960 / 760 II (Eurocode 8812ASCSS6B)
163 361	VAG	Junta fijac. protector motor/cárter - varios modelos -, fijac. pasoruada Audi 80/100/A6/A8
163 362	Renault	Fijac. anagramas Captur, Clio III, Espace IV, Kangoo II, Laguna I / II y III, Megane II, Megane III, Modus, Scenic II, Twingo II
163 363	Renault	Fijac. rejilla a calandra Kangoo II, fijac. pasoruada Espace IV, Master III '10->
163 364	Renault	Fijac. rejilla parabrisas Modus
163 365	BMW	Boca fijac. molduras serie 1 (E87), serie 3 (E46, E90, E91, E92), s.5 (E60 y E61), s.6 (E63 y E64), s.7 (E65, E66 y E67), X3 (E83/N)
163 366	Renault	Fijac. varilla capó Clio III
163 367	universal	
	Ford	Taco fijac. parachoques y torpedo Fiesta, C-Max '03 y '11->, fijac. parachoques Fiesta '02, Fusion, fijac. apertura capó Focus '98 y '05, Mondeo '93->'07, fijac. codo lavaparabrisas Transit Connect '02
163 368	Ford	Taco fijac. aletas y pasoruada C-Max, Focus '98->'04 y '05, Transit Connect '02, fijac. capó Mondeo '00-'07
163 369	universal	
	Ford	Fijac. tapizados puerta y faro delantero Fiesta '02, Fusion, Focus '98->'04
	Mazda	Fijac. rejilla parabrisas "torpedo" Mazda 2



INDICE REFERENCIAS

FAM. 0300	Marca	Descripción
163 370	Ford	Kit reparación elevallunas Focus '98->'05, puerta derecha
163 371	Ford	Kit reparación elevallunas Focus '98->'05, puerta izquierda
163 372	VAG	Boca fijac. matrícula VW Golf III
163 373	PSA	Fijac. moldura parabrisas P-1007 '05-> (Eurocode 6547ASCMS)
163 374	PSA	Fijac. moldura lateral puerta P-407 coupe
163 375	PSA	Junta plástica fijac. protectores motor Evasion, Jumpy I y II, Xsara II, P-806, P-807, Expert I y II, fijac. parachoques C5 '04 y C8
163 376	PSA	Boca (Ø 8,2) fijac. soporte parachoques C3 Picasso, P-207, fijac. panel puerta Xsara II, P-106, P-406, fijac. panel portón trasero C3, P-3008, fijac. panel techo C8, Evasion, Jumpy, P-806, P-807, Expert, fijac. pilotos traseros Saxo, Xantia, Xsara Picasso, P-206, fij. separador tabique Berlingo y Partner '09
163 377	universal	
	PSA	Fijac. - varios usos - Berlingo, C3, C3 Picasso y Pluriel, C4, C4 Picasso, C5, Xantia, P-205, P-207, P-309, P-607, P-1007, Partner
163 379	PSA	Fijac. moldura lateral parabrisas C4 Picasso (Eurocode 2735ASCMS)
	PSA	Fijac. fijac panel puerta trasero C6, P-407
	Renault	Fijac. moldura lateral parabrisas Scenic III '10-> (Eurocode 2735ASCMS)
	Renault	Fijac. moldura lateral parabrisas Scenic III (componente del kit OEM: 768E60898R) (Eurocode 2735ASCMS)
163 380	PSA	Fijac. mecanismo alzacratales P-307 coupé y cabrio, P-308 berlina 3 puertas
	Renault	Fijac. mecanismo alzacratales Clio III, Espace IV, Laguna II, Vel Satis
163 381	Renault	Fijac. tapizados interiores Modus
163 382	Renault	Fijac. tapizados interiores Master
163 383	Renault	Fijac. aletas delanteras Clio II, Espace IV, Laguna II, Scenic
163 384	universal	
	Renault	Remache fijac. parachoques Twingo y otros usos Clio I, Espace IV, Vel Satis
163 385	universal	
	Nissan	Fijac. tapizados interiores Primastar
	Opel	Fijac. tapizados interiores Vivaro
	Renault	Fijac. tapizados interiores Trafic
163 386	universal	
	PSA	Fijac. tapizados interiores Berlingo '09, C3, C3 Picasso y Pluriel, P-307, P-407, Expert III, P-1007, P-3008, Partner '09
163 387	VAG	Fijac. panel puerta Audi A3 '03-> (4 puertas)
163 388	VAG	Fijac. parachoques Audi A4 '01, Superb, VW Polo '00->, fijac. pasoruada VW Caddy '04, Phaeton
163 389	universal	
	VAG	Remache fijac. varios usos Audi A4, A6
	Volvo	Remache fijac. moldura y panel puerta C70 '06->, fij. otros usos 850, S70/V70 '97->'00
163 390	universal	
	VAG	Remache (Negro) fij. tapizados interiores Bora, Caddy '04, Golf III y IV, LT, EOS, Jetta, Passat '05, Phaeton, Polo '95, Tiguan, Touran, Transporter, Vento fijac. parachoques y radiador LT, Transporter
163 391	universal	
	VAG	Remache (Gris) fijac. tapizados interiores Bora, Caddy '04, Golf III y IV, LT, EOS, Jetta, Passat '05, Phaeton, Polo '95, Tiguan, Touran, Transporter, Vento fijac. parachoques y radiador LT, Transporter



INDICE REFERENCIAS

FAM. 0300	Marca	Descripción
163 392	universal	
	VAG	Remache fijac. varios usos Seat Altea, Ibiza '06->, León II, Toledo III
163 393	VAG	Fijac. revestimientos interiores Audi A3, A4, A5, A6, Q7, TT, VW Caddy '04, Golf V y VI, Passat '05, Scirocco '09, Tiguan, y fij. pasoruada Audi A3 '13, León '13
163 394	BMW	Boca fijac. molduras laterales -varios modelos-
	Fiat	Boca fijac. moldura lateral Fiat Multipla, Lancia Y '00
	VAG	Boca fijac. molduras Audi A3, Q3, Q5, Seat Altea, Leon '99, Toledo '99->'13, VW Bora, Golf III, Passat ->'05, Touareg
163 395	VAG	Fijac. moldura lateral VW Touareg
163 396	VAG	Fijac. juntas goma puerta Audi A4 '01->, A6 '05->, R8
163 397	Fiat	Fijac. panel puerta y revestimientos interiores Fiat Grande Punto '05->
163 398	Fiat	Fijac. panel puerta y revestimientos interiores Fiat Grande Punto '05->
163 399	Fiat	Fijac. parachoques Alfa Romeo Giulietta, Fiat Grande Punto '05->, moldura lateral Fiat Panda '03->, Dobló '09->
163 400	Fiat	Kit reparación faro derecho Panda '03->
163 401	Fiat	Kit reparación faro izquierdo Panda '03->
163 402	Fiat	Kit reparación faro derecho Fiat Idea, Multipla, Lancia Musa
163 403	Fiat	Kit reparación faro izquierdo Fiat Idea, Multipla, Lancia Musa
163 404	PSA	Fijac. aletas delanteras P-307 y fijac. aletas y capó P-3008
163 405	Mercedes	Fijac. varios usos Mercedes
163 406	Mercedes	Fijac. gomas puerta y capó Mercedes 300, 400, 500,600
163 407	Mercedes	Fijac. tapizados interiores 240, 270, 320
163 408	Mercedes	Fijac. tapizados puertas laterales y portón trasero Vito (W639), Sprinter
163 409	universal	
	Mercedes	Remache fijac. tapizados interiores Sprinter
	VAG	Remache fijac. parachoque Seat Ibiza '08, León '13
163 410	Mercedes	Fijac. varios usos Mercedes
163 411	Mercedes	Fijac. moldura lateral - varios modelos -
163 412	Mercedes	Fijac. moldura (124)
163 413	Mercedes	Fijac. moldura lateral (190-201)
163 414	Mercedes	Fijac. moldura lateral (190-201)
163 415	Mercedes	Fijac. moldura lateral - varios -
163 416	Mercedes	Fijac. moldura lateral - varios modelos -
	Mercedes	Boca fijac. molduras - varios modelos -
163 417	Rover	Fijación moldura inferior parabrisas Evoque, y Range Rover '02 y '10-> (Eurocode 7042ASSRS)
163 418	Mercedes	Boca fijac. molduras Mercedes 202
163 419	Mercedes	Boca fijac. molduras Mercedes 200, 230, 250, 300
163 420	Mercedes	Fijac. moldura lateral 200, 220, 230, 300, 320
163 421	Mercedes	Fijac. moldura lateral 200, 230, 250, 260, 300
163 422	Mercedes	Fijac. moldura lateral 300, 400, 500, 600
163 423	Mercedes	Fijac. moldura lateral 300, 400, 500, 600
163 424	Mercedes	Fijac. tapizados techo furgonetas Mercedes



INDICE REFERENCIAS

FAM. 0300	Marca	Descripción
163 425	Fiat	Base soporte parabrisas Iveco Daily (Eurocode 7247ASCV)
	Opel	Base soporte parabrisas Movano (Eurocode 7247ASCV)
	Renault	Base soporte parabrisas Master II (Eurocode 7247ASCV)
163 426	universal	
	Renault	Taco fijac. embellecedor exterior puerta Laguna III, Latitude, Megane III, Fluence, fijac. armazón delantero Twingo
163 427	universal	
	Renault	Taco fijac. armazón delantero Twingo
163 428	Renault	Fijac. varios usos Scenic II, Twingo II
	VAG	Fijac. faro antiniebla A2, A3 '01->'08, A4 '99->'08, A6 '98->'05, A8, fijac. parachoques A6 '98->'05
163 429	Renault	Fijac. varios usos Clio III
163 430	Opel	Fijac. moldura lateral puerta Astra G '98->'03
163 431	Opel	Fijac. moldura rejilla lavaparabrisas "torpedo" Astra H '04->, Zafira B '05-> (Eurocode 6302ASCHB)
163 432	Opel	Fijac. molduras laterales Vectra B
163 433	Opel	Fijac. molduras laterales Vectra B
163 434	Opel	Fijac. molduras laterales Signum, Vectra C
163 436	Opel	Fijac. junta puerta Astra G, Insignia, Zafira A
163 437	Opel	Fijac. (tornillo Ø 5) pasorueda Astra J, Meriva B '10->, fijac. revestimientos interiores Astra F, G y H, Calibra, Corsa A, B, C y D, Meriva, Insignia, Signum, Vectra B y C, Zafira A y B
163 439	universal	
	Ford	Taco fijac. revestimientos interiores Fiesta '02, Focus '05, C-Max, parachoques delantero Transit '06
163 440	Opel	Taco fijac. piloto trasero Astra H, fijac. faro delantero Astra F, Calibra, Omega, Senator, Vectra A, fijac. rejilla radiador Corsa B, Combo
	Ford	Fijac. insonorizante capó y tapizados interiores Focus '05, Galaxy '06, Kuga '08, Mondeo '07, S-Max '06
163 441	Ford	Fijac. panel puerta Focus '04, C-Max '03->'10
163 442	universal	
	Ford	Fijac. tapizados interiores S-Max, Galaxy '06
163 443	Ford	Taco fijac. puertas Fiesta '89->'96, Escort
163 444	Renault	Fijac. (Ø 8,2) bandas portón y maletero Clio II
163 445	Renault	Fijac. (Ø 12,2) bandas portón y maletero Clio II, Megane Break
163 446	Renault	Fijac. molduras laterales Clio III, Megane III Coupé, Twingo II
163 447	Renault	Fijac. tapizados interiores Kangoo
163 448	universal	
	Nissan	Fijac. rejilla radiador Cabstar '06->, Juke, Murano, Note, fijac. parachoques trasero Mira '03->'10, Note, fijac. spoiler delantero Micra '10->
163 449	Renault	Remache fijac. tapizados interiores Kangoo
	Renault	Remache fijac. tapizados interiores Laguna II, Scenic II
163 450	Renault	Fijac. (Ø 5,2) gomas puerta Clio III
163 451	Renault	Fijac. (Ø 6,2) gomas puerta Clio III
163 452	Renault	Fijac. anagramas Clio III y IV, Espace IV, Megane II, Twingo II, fijac. embellecedor superior aleta Clio III y IV, Megane III



INDICE REFERENCIAS

FAM. 0300	Marca	Descripción
163 453	Fiat	Fijac. panel puerta Fiat Scudo III
	PSA	Fijac. panel puerta lateral deslizante Expert III, Jumpy III, fijac. moldura lateral Expert, y fijac. tapizados maletero P-308 '14->, P-508
	Renault	Fijac. moldura parabrisas Clio IV '12->
	Renault	Fijac. panel puerta Wind
163 454	BMW	Fijac. pasoruedas serie 1 (E87), s.3 (E36, E46, E90, E91, E92), s.5 (E34, E60, E61)
	Mini	Fijac. pasoruedas R56
163 455	BMW	Fijac. pasoruedas serie 1 (E87), serie 3 (E36, E46, E90, E91, E92), s.7 (E65, E66, E67), X3 (E83, E83N), X5 (E53), Z4
163 456	BMW	Fij. moldura parabrisas s.5 '02-> (E60/E61), X3 (F25), X5 '07-> (E70) y X6 (Eurocode 2445ASCSS)
163 457	BMW	Fijac. moldura talonera serie 1 (E81/82/87/88), serie 3 (E90/91/92/93), serie 6 (F12), X1 y X6 (monta con 163.458)
163 458	BMW	Fijac. moldura talonera serie 1 (E81/82/87/88), serie 3 (E90/91/92/93), serie 6 (F12), X1 y X6 (monta con 163.457)
163 459	BMW	Fijac. moldura talonera s.3 Coupé / Cabrio (E92 / E93), s.6 (E63 y E64)
163 460	BMW	Boca fijac. emblemas BMW - todos los modelos -
163 461	Mercedes	Fijac. molduras superior parabrisas Clase E '95->'02 (W210) (Eurocode 5337ASCST)
163 462	Mercedes	Base parabrisas Clase E '02->'08 (W211) (Eurocode 5347ASCBS)
163 463	Mercedes	Fijac. molduras lateral parabrisas Clase A '05-> (W169), Clase B '05-> (W245)
163 464	Mercedes	Fijac. rejilla parabrisas («torpedo») Clase A '05-> (W169), Clase B '05-> (W245) y fijac. moldura portón trasero Clase C '00->'07 (W203)
163 465	BMW	Fijac. tapizados puerta serie 3 (E36)
163 467	BMW	Fijac. pasoruada serie 3 (E90/E91 335i Touring), X1, X3 (E83/E83N), X5 (E53/E70) y Z4 (E85/E86)
163 468	VAG	Fijac. tapizados puerta Audi A3 '04->, A4 '01->'08, Seat Exeo (Eurocode 8572LSCSFD51B)
163 469	VAG	Fijac. tapizados interiores VW Fox, Gol, Parati, Saveiro
163 470	VAG	Fijac. panel puerta Audi A1, A4 '08->, A5, A6 '11, A7, A8 '10, Q3, Q5, Q7, Seat Alhambra '10, Skoda Rapid, VW Golf VI '09, Passat '11, Polo '10, Scirocco '09, Touareg '03, Transporter '03 y fij. panel puerta corredera y otros usos interiores Caddy '04 y '11-> (Eurocode 8579SSCVFD)
	Volvo	Remache fijac. panel puerta C30, C70, S40 '04->, V50 (Eurocode 8579SSCVFD)
163 471	Renault	Fijac. varilla capó Laguna III
163 472	Mazda	Fijac. tapizados interiores Mazda 6, 626, Demio
163 473	Mazda	Fijac. tapizados interiores Mazda 323, 626, Premacy
163 474	universal	
	Mazda	Remache roscado fijac. pasoruada y aletas Mazda 323, 626, Demio
163 475	universal	
	Suzuki	Fijac. tapizados interiores - varios modelos -
163 476	universal	
	Fiat	Fijac. pasoruada, parachoque y bajos carrocería Fiat Sedici '06
	Honda	Fijac. pasoruada - varios modelos -
	Lexus	Fijac. pasoruada SC430 '01-'10, otros usos GX460 '10->, LX570 '07->
	Suzuki	Fijac. parachoques, pasoruada y talonera puerta Aerio/Liana '02, Grand Vitara, Jimny, Swift, SX4 '06
	Toyota	Fijac. pasoruada Auris, Avensis '97->'02 y '08->, Camry, Corolla '01->'06 y '06->, Corolla Verso '09->, IQ '08, HiAce, Previa, Prius '03->'09, Yaris '99->'05 y '05->, Yaris Verso, fijac. bajos carrocería Avensis Verso '01->'09, Celica '99->'05, MR2, Rav4 '00->'05
163 477	Subaru	Fijac. rejilla radiador Forester
163 478	Subaru	Fijac. rejilla radiador Forester



INDICE REFERENCIAS

FAM. 0300	Marca	Descripción
163 479	Subaru	Fijac. moldura parabrisas Subaru Impreza '93->'98, Forester (Eurocode 7915ASCHS)
163 480	Nissan	Fijac. varias capó Primera
163 481	Nissan	Fijac. soporte parachoques Micra
	universal	
163 482	Honda	Fijac. tapizados interiores Accord '03->'07, Civic '01->, CRV '02->'06, Jazz '07->, NSX, S2000 '00->
	Mitsubishi	Fijación pasoruada Montero, fijación rejilla radiador Montero/Pajero, fijación parachoques Galant, Space Runner
	Nissan	Fijac. pasoruada Qashqai, X-Trail, fijac. parachoques, aletas, rejilla calandra Qashqai
163 483	Nissan	Fijac. panel puerta Primera
	universal	
163 484	Nissan	Fijac. tapizados puerta X-Trail
	universal	
	Mercedes	Remache fijac. varios usos clase B (W245), Vito (W638 y W639)
163 485	PSA	Remache fijac. parachoques, tapizados interiores y otros usos Berlingo, C2, C3 '10->, C3 Picasso, C4, C4 Picasso, C5, C6, C8, DS3, Jumpy, Xantia, Xsara, Xsara Picasso, P-207, P-307, P-308, P-406, P-407, P-607, P-806, P-807, P-3008, P-5008, Expert I, II y III, Partner
	Smart	Fijac. pasoruada Smart ForTwo
	VAG	Remache fijac. tapizados interiores Audi A4, A6, Q5, Q7
	universal	
163 486	PSA	Remache fijac. varios usos C3, C4, C5, C8, P-307, P-607, P-807
	Renault	Remache fijac. varios usos
	universal	
163 487	Mercedes	Remache fijac. parachoques delantero Vito (W638/639)
	PSA	Remache fijac. varios usos C3, C4, C5, C8, P-307, P-607, P-807
	Renault	Remache fijac. varios usos
163 488	Dacia	Fijac. molduras puerta Logan
	universal	
163 489	Dacia	Fijac. tapizados interiores Logan (gris)
	universal	
163 490	Dacia	Fijac. tapizados interiores Logan
163 491	Dacia	Fijac. panel puerta Logan
163 492	Fiat	Fijac. cristal lateral Fiat Punto '93 y '03->, Lancia Y
163 493	Fiat	Fijac. pasoruada Ducato, y fij. tapizados interiores y protecciones Fiat Bravo/a, Fiorino, Panda '03, Talento, Uno
	PSA	Fijac. pasoruada Jumper, Boxer
	universal	
163 494	Fiat	Fijac. tapizados Alfa Romeo 145, 146, 147, 155, 156, 166, Brera, GTV, Fiat Bravo/a, Ducato '02, Marea, Tipo, Tempra, Lancia - varios -
163 495	Fiat	Fijac. insonorizantes capó Alfa Romeo 159, Brera, Spider'06, Fiat Bravo '07, Cromo '05, Ducato '06, Grande Punto'05, Linea, Palio, Siena, Strada
	PSA	Fijac. insonorizantes capó Citroën Jumper III, Nemo, Peugeot Boxer III, Bipper
163 496	Fiat	Fijac. tapizados interiores Fiat Cinquecento, Cromo, Dobló, Multipla, Palio, Punt, Seicento, Siena, Strada, Tempra, Tipo, Lancia Dedra, Delta, Nuevo Delta
163 497	Fiat	Fijación tapizados interiores Fiat Dobló
	universal	
163 498	Fiat	Taco fijac. pasoruada Fiat Punto '03, Lancia Musa



INDICE REFERENCIAS

FAM. 0300	Marca	Descripción
163 499	Fiat	Fijac. tapizados portón trasero Fiat Croma '05, Panda '03
163 500	Fiat	Soporte cristal lateral Marea '99, Panda '03
163 501	PSA	Fijac. tapizado panel lateral Jumpy I y II, Expert I y II, fijac. tapizado techo C4 Picasso, Jumpy III, Expert III
163 502	universal	
	PSA	Taco fijac. parachoques delantero C3, fijac. tapizados interiores Berlingo '09->, C4 '11->, C5 '08->, Partner Tepee '09->, P-207 coupé, P-308, P-508, P-3008, RCZ
163 503	Renault	Taco fijac. tapizados interiores Megane II, fijac. talonera Kangoo II, fijac. moldura puerta Laguna III
	universal	
	Hyundai	Fijac. pasoruada y parachoques Accent, Azera, Coupé, Elantra, Entourage, Genesis, Getz, Santa Fe, Sonata, Tucson, ix35, ix55 (Veracruz), XG300/350, Kia Sorento, Sportage
163 504	Mazda	Fij. talonera puerta Mazda 6, pasoruada y parachoques - varios modelos-
	Toyota	Fijac. pasoruada y parachoques Corolla -> '95, otros usos HiLux, 4Runner
163 504	Renault	Fijac. moldura aleta delantera Clio III y IV, Twingo II
163 505	universal	
	Ford	Taco fijac. faro antiniebla a parrilla delantera C-Max, Fiesta '08, Focus '05, Kuga '08
163 507	Mazda	Fijac. moldura parabrisas Mazda 323, 929, Mercury Tracer, Truck (Eurocode 5117ASCS)
163 508	Ford	Soporte faro delantero Focus '05->
163 509	Suzuki	Fijac. tapizados interiores - varios modelos -
163 510	Suzuki	Fijac. tapizados interiores - varios modelos -
163 512	Suzuki	Fijac. tapizados interiores - varios modelos -
163 513	Suzuki	Boca fijac. varios usos - varios modelos -
163 514	Suzuki	Fijac. tapizados interiores - varios modelos -
163 515	Honda	Fijac. panel puerta y tapizados interiores - varios modelos -
163 516	Honda	Fijac. panel puerta y tapizados interiores - varios modelos -
163 517	Honda	Fijac. panel puerta y tapizados interiores Accord '03->'07, Civic '02->'05, CRV '08->, Odyssey '05->
163 518	Honda	Fijac. panel puerta y tapizados int. Accord '08->, Civic '05->, CRV '02->, Jazz, Odyssey '05->
163 519	universal	
	Honda	Fijac. panel puerta y tapizados interiores Accord -todos-, Civic -todos-, CRV '07->, CRX '84->'91, Element '03->, Insight, Integra, Jazz '07->, Odyssey '95->, Prelude '79->'01, Pilot '03->
163 520	Honda	Fijac. tapizados portón Accord, Acty, Civic, CRX, HRV, Logo, Prelude, Shuttle, fijac. parachoques Jazz
	Mazda	Fijac. tapizados interiores - varios modelos-
	Nissan	Fijac. tapizados interiores - varios modelos -
	Toyota	Fijac. tapizados interiores - varios modelos -
163 521	Mazda	Fijac. varios usos Mazda - varios modelos -
163 522	Mazda	Fijac. varios usos Mazda - varios modelos -
163 523	Toyota	Fijac. parachoques trasero Carina E T19 '92->'97
163 524	Toyota	Fijac. parachoques trasero Carina E T19 '92->'97
163 525	Toyota	Fijac. parachoques trasero Picnic XM10 '96->'01
163 526	Lexus	Fijac. moldura lateral puerta RX300 '00->'03
	Toyota	Fijac. revestimientos interiores - varios modelos -
163 527	Lexus	Fijac. moldura lateral puerta RX300 '00->'03
	Toyota	Fijac. revestimientos interiores - varios modelos -



INDICE REFERENCIAS

FAM. 0300	Marca	Descripción
163 528	Lexus	Fijac. moldura lateral puerta GS30/35/43/460, GS450H
	Toyota	Fijac. moldura portón trasero Land Cruiser '02->'09, moldura ventanilla trasera Corolla ->'97, MR2, Starlet ->'99
163 529	universal	
	Lexus	Fijac. moldura pasoruada GS30/35, GS450H, GX460, fijac. protector maletero RX300/350/400H
	PSA	Remache fijac. pasoruada C1, P-107, fij. junta rejilla aireación C1 '14->, P108
163 530	Toyota	Fijac. moldura pasoruada Auris, Avensis '03->'08 y '08->, Aygo, Corolla '06, Corolla Verso, Yaris '99, Rav4 '05, fij. bajos carrocería Auris, Avensis '03, Corolla '01, Prius '09, Rav4 '05
	universal	
163 531	Lexus	Fijac. bajos carrocería CT200H '10->
	Toyota	Fijac. bajos carrocería Auris, Avensis '08, Corolla Verso '09, fijac. aleta Yaris ->'05, Yaris Verso
163 532	Mazda	Fijac. panel puerta - varios modelos -
	Suzuki	Fijac. tapizados - varios modelos -
	Toyota	Fijac. tapizados interiores Celica, Corolla, HiAce, HiLux, Land Cruiser (modelos antiguos)
163 533	Toyota	Fijac. tapizados interiores Celica, MR2, Picnic, Previa, Starlet, HiLux '97->'05, Land Cruiser '90->'07
163 534	Toyota	Fijac. tapizados Camry, Cressida, MR2, Starlet, Land Cruiser ->'89
163 535	Toyota	Fijac. tapizados interiores Land Cruiser Prado '02->'09
163 536	Toyota	Fijac. tapizados - varios modelos -
163 537	Toyota	Fijac. goma capó Yaris '99->'05, Yaris Verso, HiLux '05->, Land Cruiser '96->'02 y '02->'09
163 538	Mercedes	Fijac. moldura parabrisas derecho Vito (W638) Clase V (negra) (Eurocode 5428ASCVR)
163 539	universal	
	Mitsubishi	Taco fijac. tapizados - varios modelos -
163 540	Mitsubishi	Fijac. moldura pasoruada - varios modelos -
163 541	VAG	Tapón fijac. protector motor/cárter - varios modelos - VW Polo, Golf III, Touran, Sharan
163 542	VAG	Fijac. panel puerta VW Caddy '04, EOS, Golf V '04->'09, Passat '05->, Phaeton, Polo '02 y '10->, Tiguan, Touran (Eurocode 8568LSCHFD)
163 543	VAG	Fijac. insonorizante capó Audi A1, A3, A4w, A5, A6, A8, Q5, Q7, TT, VW Caddy '11, Passat '11-> (largo 20 mm.)
163 544	VAG	Boca fijac. tapizados Seat Alhambra, Skoda Fabia. Octavia, VW Golf III, Polo, Sharan, Touran
163 545	VAG	Fijac. rejilla parabrisas "torpedo" Seat Altea, Leon '05, Toledo '05-> (Eurocode 7610LSCHRQ)
	VAG	Fijac. tapizados interiores pilar B y C Seat Altea, Ibiza/Cordoba '02->'08, Leon '05, Toledo '05, fijac. moldura rejilla parabrisas "torpedo" Seat Altea, Leon '05, Toledo '05-> (Eurocode 7610LSCHRQ)
163 546	VAG	Soporte cristal elevalunas trasero derecho Seat Leon '99->'05, Toledo '99->'04
163 547	VAG	Soporte cristal elevalunas trasero izquierdo Seat Leon '99->'05, Toledo '99->'04
163 548	Hyundai	Soporte cristal elevalunas derecho Accent
163 549	Hyundai	Soporte cristal elevalunas izquierdo Accent
163 550	Mercedes	Soporte cristal elevalunas derecho Vito
163 551	Mercedes	Soporte cristal elevalunas izquierdo Vito
163 552	Fiat	Soporte cristal elevalunas derecho Fiat Dobló '00->'09
163 553	Fiat	Soporte cristal elevalunas izquierdo Fiat Dobló '00->'09
163 554	BMW	Soporte cristal elevalunas trasero derecho serie 3 (E46)
163 555	BMW	Soporte cristal elevalunas trasero izquierdo serie 3 (E46)
163 556	BMW	Soporte (aluminio) cristal elevalunas trasero dcho./izdo. serie 5 (E39)
163 557	Opel	Soporte cristal elevalunas derecho e izquierdo Corsa



INDICE REFERENCIAS

FAM. 0300	Marca	Descripción
163 560	Opel	Soporte cristal elevalunas derecho e izquierdo Astra, Vectra
163 561	Opel	Patín cristal elevalunas derecho e izquierdo Astra, Vectra
163 562	Opel	Soporte cristal elevalunas derecho Meriva
163 563	Opel	Soporte cristal elevalunas izquierdo Meriva
163 564	Ford	Soporte cristal elevalunas Galaxy, puerta derecha
	VAG	Soporte cristal elevalunas derecho Seat Alhambra, VW Sharan
163 565	Ford	Soporte cristal elevalunas Galaxy, puerta izquierda
	VAG	Soporte cristal elevalunas izquierdo Seat Alhambra, VW Sharan
163 566	Ford	Soporte cristal elevalunas trasero derecho Focus '98->'05
163 567	Ford	Soporte cristal elevalunas trasero izquierdo Focus '98->'05
163 568	Ford	Soporte cristal elevalunas derecho Ka, Mondeo
163 569	Ford	Soporte cristal elevalunas izquierdo Ka, Mondeo
163 570	Ford	Soporte cristal elevalunas trasero derecho Fiesta '96->'02
163 571	Ford	Soporte cristal elevalunas trasero izquierdo Fiesta '96->'02
163 574	Renault	Soporte cristal elevalunas delantero derecho Megane I
163 575	Renault	Soporte cristal elevalunas delantero izquierdo Megane I
163 576	Renault	Soporte cristal elevalunas trasero derecho Megane I
163 577	Renault	Soporte cristal elevalunas trasero izquierdo Megane I
163 578	Renault	Soporte cristal elevalunas delantero derecho Scenic I
163 579	Renault	Soporte cristal elevalunas delantero izquierdo Scenic I
163 580	Renault	Soporte cristal elevalunas trasero derecho Scenic I
163 581	Renault	Soporte cristal elevalunas trasero izquierdo Scenic I
163 584	Renault	Soporte cristal elevalunas trasero derecho Megane II
163 585	Renault	Soporte cristal elevalunas trasero izquierdo Megane II
163 588	PSA	Soporte cristal elevalunas delantero derecho P-106, Saxo
163 589	PSA	Soporte cristal elevalunas delantero izquierdo P-106, Saxo
163 590	PSA	Soporte cristal elevalunas delantero derecho P-306
163 591	PSA	Soporte cristal elevalunas delantero izquierdo P-306
163 594	Ford	Fijac. panel puerta C-Max '11->, fij. spoiler trasero Focus '11->
	Nissan	Fijac. "torpedo" parabrisas Cabstar '06-> (Eurocode 6045ASCVB)
	Opel	Fijac. "torpedo" parabrisas Meriva B '10-> (Eurocode 6558LSCVFD)
	PSA	Fijac. rejilla parabrisas C4 Picasso (Eurocode 6558LSCVFD)
	PSA	Fijac. panel puerta C3 '10->, C3 Picasso, C4, C4 Picasso, DS3, Jumpy 3, P-307, P-308, P-3008, P-5008, Expert 3, fijac. tapiz. interiores, portón trasero y retrovisores Berlingo '09, C5 '08->, P-407, P-508, Partner '09
163 595	Renault	Fijac. moldura parabrisas Megane II Coupé / Cabrio (componente del kit Renault 7701209200) (Eurocode 7261ASCC/AKCC1F)
	Renault	Fijac. tapizados interiores Megane II 2 puertas y Megane CC
163 596	PSA	Soporte cristal elevalunas delantero derecho Xsara Picasso
163 597	PSA	Soporte cristal elevalunas delantero izquierdo Xsara Picasso
163 602	VAG	Kit reparación elevalunas delantero derecho VW Golf IV (aluminio) '98->'04
163 603	VAG	Kit reparación elevalunas delantero izquierdo VW Golf IV (aluminio) '98->'04



INDICE REFERENCIAS

FAM. 0300	Marca	Descripción
163 604	VAG	Soporte cristal elevalunas trasero derecho VW Golf IV '98->'04
163 605	VAG	Soporte cristal elevalunas trasero izquierdo VW Golf IV '98->'04
163 606	Fiat	Kit reparación faro derecho Punto '03->
163 607	Fiat	Kit reparación faro izquierdo Punto '03->
163 608	Fiat	Fijac. rejilla lavaparabrisas "torpedo" Grande Punto '05, Punto '12->
	Fiat	Fijac. rejilla lavaparabrisas "torpedo" Grande Punto '05, Punto '12->, fijac. tapizados portón trasero Croma '05->
163 609	Fiat	Fijac. cristal lateral Ducato '94, Ducato Restyling, Grande Punto '05->
163 610	universal	
	Fiat	Remache fijac. protector motor y tapizados Croma '05->
163 611	universal	
	Fiat	Taco fijac. matrícula Iveco Daily
163 612	Fiat	Fijac. moldura lateral Iveco Daily '06->
163 613	Ford	Fijac. rejilla lavaparabrisas "torpedo" Mondeo I, Orion. Scorpio (Eurocode 3546ASCHB)
163 614	Opel	Fijac. tapizados puerta Astra H, Corsa C, Meriva A y B, Signum, Vectra B y C, Zafira B, fijac. tapizados interiores Astra G, Corsa B
163 615	Nissan	Fijac. insonorizante capó Almera, Maxima, Micra '92, Micra '03
163 616	Suzuki	Fijac. revestimientos interiores Jimny, Vitara, Grand Vitara, fijac. spoiler Jimny, fijac. parachoques delantero Grand Vitara, Swift
163 617	Suzuki	Fijac. moldura lateral Liana, Vitara, Gran Vitara
163 618	Honda	Fijación tapizados interiores Accord '83->'89, Civic '80->'87, CRX '84->'87, Integra, Legend, Prelude '79->'87
163 619	Mazda	Fijac. aletas, pasoruada y cubre cárter - varios modelos -
	Toyota	Fijac. maneta interior Carina
163 620	Toyota	Fijación tapizados interiores y panel puerta Avensis '97->'02, Corolla '97->'01, HiAce '95->, Land Cruiser '96->'02, MR2, Picnic, Previa, Prius '00->'03, Rav4 '94->'00, Yaris '99->'05
163 621	Lexus	Fijac. tapizados interiores IS250/350, IS F, GS30/35/43, GS450H, LS430, LS460, RX300/330/350, RX400H
	Toyota	Fijac. tapizados interiores Auris '07, Camry '06->, Celica, Corolla '06->, IQ '08->, Land Cruiser '07->, Prius '09, Rav4 '00->, Urban Cruiser '09, Verso-S, Yaris '05->, fijac. portón trasero Avensis '97->'08, Corolla '97->'06, fijac. moldura techo Avensis '08->
163 622	universal	
	Toyota	Fijac. moldura guardabarros Corolla
163 623	Mini	Fijac. moldura aletines pasoruada y parachoques R50, R52, R53, R56 y R57 ->08/'10
163 624	Mini	Fijac. moldura pasoruada delantero R50, R52 y R53
163 625	Mini	Fijac. moldura aleta pasoruada trasero R50, R52 y R53
163 626	Mini	Fijac. moldura pasoruada a capó R50, R52 y R53
163 627	Mini	Fijac. moldura talonera puerta R50, R53 y R56
163 628	Mini	Fijac. moldura talonera puerta R50, R52, R53, R56 y F56 '14->
163 629	Mini	Fijac. moldura talonera puerta R50, R52, R53 y R56
163 632	PSA	Boca (Ø 9) fijac. panel puerta Jumpy I, II y III, Expert I, II y III, fij. detector presión ruedas C8, P-807
163 634	PSA	Fijac. rejilla de calandra delantera Berlingo '02->'08, Partner '03->'08, fijac. deflector rejilla parabrisas P-306



INDICE REFERENCIAS

FAM. 0300	Marca	Descripción
163 635	PSA	Fijac. parachoques Berlingo '02->'08, C3 ->'04, Xsara, Xsara Picasso, P-1007, Partner '02->'08, fijac. rejilla parabrisas "torpedo" P-306
163 636	Mini	Fijac. moldura lateral parabrisas R52, R60 Countryman, R61 Paceman, F56 '14->
163 637	VAG	Fijac. moldura lateral parabrisas Seat León '05-> (Eurocode 7613ASCHS)
163 638	PSA	Fijac. aletas delanteras Citroën C4, Peugeot P-307, P-308
163 639	Rover	Fijación moldura parabrisas Range Rover '02->'09, Range Rover Sport '05 y '10->, Discovery 3 y 4 (Eurocode 7033ASCRS)
	universal	
163 640	Mercedes	Fijac. rejilla parabrisas "torpedo" Clase C '07-> (W204) (Eurocode 5364ASSSB)
	Mercedes	Remache fijac. varios usos W123, W124, W126, W211, W219 (Eurocode 5364ASSSB)
163 641	Ford	Base soporte parabrisas Focus '98->'04
163 642	Opel	Fijac. moldura techo-parabrisas (parte central) Astra G Coupé, Sedán y Familiar
163 643	Mitsubishi	Fijac. moldura parabrisas Carisma '95->'03, Space Star '98->'04
	Volvo	Fijac. moldura inferior parabrisas S40/V40 '00->'04 (Eurocode 8824ASDS/ASSS)
163 644	Volvo	Fijac. rejilla parabrisas "torpedo" V40 '00->'04 (Eurocode 8832ASCSB6B)
163 645	PSA	Base soporte parabrisas Citroën Saxo, Peugeot 106 Restyling (Eurocode 6520ASMH)
163 646	Volvo	Fijac. rejilla parabrisas "torpedo" S40/V40 '00->'04
163 647	Volvo	Fijac. rejilla parabrisas "torpedo" S40/V40 '00->'04 (Eurocode 8824ASCSB)
163 648	VAG	Fijac. tapizados interiores Seat Ibiza '09, VW Golf V y VI, Golf Plus, Passat '05->, Scirocco '09, Tiguan, Touran
163 649	Mercedes	Fijac. tapizados y panel puerta - varios modelos -
	Mitsubishi	Fijac. moldura parabrisas Space Star, fij. panel puerta Carisma '95->'03, Colt '04->
163 650	Lexus	Fijac. moldura lateral parabrisas IS F '08->, GX460 '09-> (Eurocode 8371ASCSS)
163 651	Mini	Fijac. moldura inferior parabrisas R50, R52, R53 (Eurocode 2440ASCHB)
163 652	Mini	Fijac. moldura inferior parabrisas R50, R52, R53 (Eurocode 2440ASCHB1B)
163 653	Mini	Fijac. moldura inferior parabrisas R50, R52, R53 (Eurocode 2440ASCHB2B)
163 656	Rover	Soporte cristal elevalunas delantero derecho Land Rover Freelander
163 657	Rover	Soporte cristal elevalunas delantero izquierdo Land Rover Freelander
163 658	Rover	Soporte cristal elevalunas trasero derecho e izquierdo Land Rover Freelander
163 659	Mercedes	Soporte cristal elevalunas delantero derrecho e izquierdo Mercedes S320
163 660	PSA	Soporte cristal elevalunas delantero derecho P-307 Coupé
	Renault	Soporte cristal elevalunas delantero derecho Laguna II
163 661	PSA	Soporte cristal elevalunas delantero izquierdo P-307 Coupé
	Renault	Soporte cristal elevalunas delantero izquierdo Laguna II
163 662	PSA	Soporte cristal elevalunas delantero derecho P-406
163 663	PSA	Soporte cristal elevalunas delantero izquierdo P-406
163 664	VAG	Kit soporte cristal elevalunas VW Touareg '03->
163 665	Renault	Soporte tapa superior motor Renault Kangoo
163 666	Dacia	Soporte cristal elevalunas delantero derecho Dacia Logan
163 667	Dacia	Soporte cristal elevalunas delantero izquierdo Dacia Logan
163 668	Renault	Kit (2 piezas) soporte parachoque delantero Kangoo II '03->, Espace IV '02->, Laguna III '07->



INDICE REFERENCIAS

FAM. 0300	Marca	Descripción
163 669	PSA	Fijac. panel puerta Citroën C4 '10->, C4 Picasso '13->, DS4, P-308 '14->, P-508
	Renault	Fijac. panel puerta Laguna III, Latitude, Megane III, Fluence, Scenic III, Master III '10-> (Eurocode 7280SSSCMFD)
163 670	Renault	Fijac. rejilla parabrisas "torpedo" Espace IV '02-> (Eurocode 7251ASCVB)
163 671	Renault	Fijac. moldura techo-parabrisas Laguna III '07->
163 672	PSA	Fijac. moldura lateral parabrisas C5 '08->, P-508 (Eurocode 2740ASCSS)
163 673	Renault	Fijac. moldura lateral parabrisas Clio III, Symbol, Thalia (Eurocode 7262ASCHS)
163 674	Renault	Fijac. moldura lateral parabrisas (parte inferior) Clio III (Eurocode 7262ASCHS1B)
163 675	Opel	Fijac. moldura portón trasero Zafira
163 676	Opel	Fijac. moldura portón trasero Zafira
163 677	Opel	Fijación moldura talonera puerta Vectra B, fijación tapizados interiores Meriva, Combo, fijac. faro delantero Corsa D universal
163 678	Opel	Fijac. moldura pasoruada Astra F, Kadett, Vectra A, fijac. panel radiador Corsa B
163 679	Opel	Fijac. tapizados interiores pilar central Astra G, Zafira A
163 680	Opel	Fijac. tapizados interiores Astra F
163 681	Ford	Fijac. panel puerta Focus '04, C-Max '03->'07, fijac. portón trasero Fiesta '02->'08 y '08->
163 682	Ford	Fijac. panel puerta Fiesta '02->'08 y '08->, C-Max '03->'07
163 683	Ford	Fij. revestimientos interiores C-Max, Fiesta '96->'01 y '02->, Focus, Kuga, Mondeo '93->'07 y '07->, Transit '94->'06 y '06->, Transit Connect
163 684	Ford	Fijac. juntas goma puerta Mondeo '00->'07
163 685	Ford	Fijac. tapizados portón trasero Focus '04, C-Max '03->'07
163 686	Ford	Fijac. tapizados portón trasero Focus '04
163 687	VAG	Fijac. junta goma puerta Skoda Superb '02->'08, VW Bora, Golf IV, Passat '97->'05
163 688	Hyundai	Fij. moldura lateral Hyundai Getz, Matrix, Santa Fe, Sonata, Tucson, Kia Carnival, Sorento, Sportage, fijac. pasoruada Hyundai Accent, Elantra, Genesis, Santa Fe, Sonata, Kia Sorento, fijac. parachoques Hyundai Tucson, ix55 (Veracruz), Kia Sportage
163 689	universal	
	Hyundai	Fijación parachoques y tapizados interiores Accent, Atos, Azera, Elantra, Genesis, Sonata, fijac. moldura lateral Galloper
163 690	Hyundai	Fijac. moldura lateral Hyundai Accent, Getz, Matrix, Kia Sorento
163 691	Hyundai	Fijac. moldura lateral Hyundai Accent, Atos, Entourage, Matrix, Santa Fe, Sonata
163 692	Hyundai	Fijac. parrilla radiador Tucson, fijac. moldura lateral Hyundai Genesis, Sonata, Terracan
163 693	Hyundai	Fijac. parrilla radiador Elantra, fij. moldura lateral Hyundai Terracan
163 694	Hyundai	Fijac. moldura lateral Hyundai Accent, Atos
163 695	Hyundai	Fijac. moldura lateral Hyundai Atos, Santa Fe, Kia Picanto, Sorento
163 696	Hyundai	Fijac. moldura lateral Hyundai Entourage, Santa Fe, Sonata, Tucson, ix55, Kia Sorento, Sportage
163 697	Hyundai	Fijac. moldura lateral Hyundai Azera, Coupé, Tiburon, XG300/350
163 698	Hyundai	Fijac. moldura lateral Hyundai Coupé (Tiburón), Entourage, Genesis, Santa Fe, Tucson, ix55, Kia Sorento, Sportage
163 699	Hyundai	Fijac. moldura lateral Hyundai Entourage, Getz, Sonata, fijac. tapizados puerta Hyundai Elantra
163 700	Hyundai	Fijac. junta goma puerta Hyundai Accent, Atos, Elantra, Santa Fe, Sonata, Tucson, ix55 (Veracruz), Kia Picanto, Rio, Sorento, Sportage
163 701	Hyundai	Fijac. junta goma puerta Hyundai Elantra '91->'00
163 702	Hyundai	Fijac. junta goma puerta Hyundai Accent ->'99, Atos, Kia 2500/2700



INDICE REFERENCIAS

FAM. 0300	Marca	Descripción
163 703	Hyundai	Fijac. junta goma puerta Hyundai Accent '99->'06, Atos, Coupé, Galloper, Santa Fe, Sonata, Kia Sorento, K2500/2700
163 704	Hyundai	Fijac. junta capó Hyundai Accent, Elantra. Equus, Santa Fe, Sonata, Tucson, XG300/350, Kia Carnival, Picanto, Rio
163 705	PSA	Fijac. moldura lateral parabrisas C6 (Eurocode 2733ASCSS)
163 706	Lexus	Fijac. moldura superior parabrisas IS F, IS 250C, LS430/460/600, LX570, GS30/35, GS450, GX460, RX300/350/400H/450H (Eurocode 8310ASCH6B)
	Toyota	Fijac. moldura superior parabr. Toyota Auris, Avensis '03->, Aygo, Camry, Celica, Corolla '01, Verso, IQ, Land Cruiser, Prius, Rav 4 '00->, Urban Cruiser, Yaris (Eurocode 8310ASCH6B)
163 707	VAG	Fijac. talonera puerta VW Golf V, Phaeton
163 708	PSA	Fijac. panel puerta C3 '10->, C5 '08->, DS3, P-206 Coupé/Cabrio, P-207 Coupé/Cabrio, P-307 Coupé/Cabrio, P-308, P-607 restyling, P-1007, fijac. tapizados interiores C3 Pluriel, C4 Picasso, fijac. rejilla parabrisas C3 Pluriel
163 709	VAG	Fijac. moldura lateral parabrisas VW Phaeton, Touareg
163 710	VAG	Fijac. moldura parabrisas VW Touran '03->
163 711	BMW	Fij. moldura lateral parabrisas X5 '07-> (E70) (Eurocode 2452ASCSS)
163 712	BMW	Fij. moldura lateral parabrisas X5 '07-> (E70) y X6 (Eurocode 2452ASCSS2B)
163 713	PSA	Fijac. moldura lateral parabrisas C4 '10->, DS4, DS5, P-308 coupé, P-3008, P-5008 (Eurocode 6560ASCMS1B)
163 714	Renault	Fijac. molduras puertas y techo Espace IV
163 715	PSA	Fijac. junta goma puerta delantera C5 '08->, delantera y trasera P-308, trasera P-3008, P-5008
163 716	PSA	Fijac. moldura techo Peugeot P-307
163 717	universal	
	PSA	Remache fijac. moldura parabrisas P-206 y P-206+ (Eurocode 6539ASCHS)
	PSA	Remache fijac. moldura parabrisas P-206 y P-206+, fijac. junta puertas P-406, fijac. indicador estacionamiento C5
	Renault	Remache fijac. varios usos
163 718	Renault	Fijac. molduras laterales puerta Megane II
163 719	Renault	Fijac. molduras laterales puerta Scenic II
163 720	Renault	Fijac. rejilla parabrisas "torpedo" Clio III
163 721	Ford	Fijac. tapizados puerta Mondeo '07, fijac. parachoques Ka '96->, fij. tapizados interiores Fiesta '02, Fusion '02
163 722	universal	
	Ford	Fijación tapizados interiores C-Max '11, Focus '04, Galaxy, Mondeo '93->'07 y '07->, S-Max '06, Transit '06, fijac. deflector delantero Fiesta '02 y '08->, Fusion
163 723	PSA	Fijac. varilla capó C3 '09->, C3 Picasso, DS3, P-207
163 724	PSA	Fij. protector bajos carrocería Berlingo '96->'08, Xsara, Xsara Picasso, ZX, P-306, Partner '96->'08
163 725	PSA	Fij. protector bajos carrocería Berlingo '96->'08, Xsara, Xsara Picasso, ZX, P-306, Partner '96->'08, fij. plancha bajo salpicadero AX, Xantia I y II, P-206 (monta junto con 163.724)
163 726	VAG	Fijac. rejilla parabrisas "torpedo" Alhambra '96->'09, Sharan '96->'05 (Eurocode 3550ASCVB)
163 727	Dacia	Fijac. panel puerta Lodgy, Sandero 2 '13->
	Mini	Fijac. moldura intermitente lateral Mini Countryman (R60)
	PSA	Fijac. tapizados interiores Berlingo '09->, C3 '09->, C4 '10->, C4 Cactus, C4 Picasso, DS3, P-5008, Partner '08, RCZ (Eurocode 6558BSCV)
163 728	PSA	Fijac. varilla capó Berlingo '96->'02, C4 Picasso, ZX, P-307, Partner '96->'02
163 729	PSA	Fijac. varilla capó Berlingo '08->, C3 ->'08, C3 Pluriel, C4 ->'10, C4 Picasso, P-3008, P-5008, Partner '08->
163 730	PSA	Fijac. moldura vierteaguas trasero P-308
163 731	PSA	Fijac. parachoques delantero Berlingo, Partner '09->, fijac. protector bajos carrocería C3 '09->, C3 Picasso, DS3, C4 '10->, C4 Picasso, C8, Jumpy I, II y III, P-207, P-607, P-806, P-807, Expert I, II y III, RCZ



INDICE REFERENCIAS

FAM. 0300	Marca	Descripción
163 732	Opel	Fijac. moldura lateral parabrisas Astra G (Eurocode 6284ASCHD)
163 733	BMW	Fij. moldura lateral parabrisas X3 '03->'10 (E83/83N) (Eurocode 2449ASCERS)
163 734	universal	
	Ford	Fij. pasoruada delantero Fiesta '02->'08, Fusion, Focus '02->'05, tapiz. portón tras. Transit '00->'06, fijac. protector interior ruedas traseras Transit '06->, fijac. aislador salpicadero Fiesta '08->
163 735	universal	
	Ford	Fijación parrilla radiador Focus '01-> y '04->, C-Max '03 y '07->, Kuga '08, Mondeo '00->'07, Transit Connect '02->
163 736	Volvo	Fijac. moldura lateral parabrisas Volvo 850 '93->'97, S70 / V70 '97->'00 y XC70 '98->'00
163 737	Renault	Fijac. moldura parabrisas Megane II Coupé / Cabrio (componente del kit 7701209200) (Eurocode 7261ASCC6B)
163 738	VAG	Refuerzo aleta delantera derecha Seat Ibiza '09->
163 739	VAG	Refuerzo aleta delantera izquierda Seat Ibiza '09->
163 740	VAG	Fijac. panel puerta Seat Mii, Toledo '13, Skoda Fabia '07->, Octavia '04->, Rapid, Roomster
163 741	Ford	Fijac. tapizados portón trasero Transit '00->'06 y '06->, fij. tapizados puerta Transit Connect '02
163 742	universal	
	Ford	Fijac. tapizados interiores Escort, Fiesta ->'01 y '08, Granada, Sierra, fijac. aislador techo Transit Connect '02, fijac. deflector aire Mondeo '00->, fijac. insonorizante Focus '98->'04 y '05->, C-Max '03->'11, Kuga '08
163 743	universal	
	VAG	Remache fijac. pasoruada Audi A2 '00->'05, A8, TT '07->, fijac. cubierta parachoque delantero Q5
163 744	universal	
	Ford	Fijac. parachoques delantero Fiesta '08->, fijac. tapizados piso Transit '06->
163 745	BMW	Fijac. tapizados interiores serie 1 (E81/E82/E87/E88), serie 3 (E36, E46, E92/E93), serie 5 (E39, E61), X6, Z3, serie 6 (E63/E64), serie 7 (E38, E65/E66)
	Mercedes	Remache fijac. parachoque ML '11->
	VAG	Remache fijac. aleta delantera Audi A3 '08->, y fij. tapizados Audi A4 '08, A6 '11, Q3
163 746	BMW	Fijac. alfombrillas serie 3 (E46), serie 5 (E34, E39), serie 7 (E32, E38)
163 747	BMW	Fijac. revestimientos interiores serie 3 (E46), X3 (E83), X5 (E53), Z4 (E85/E86)
163 748	BMW	Fijac. moldura lateral puerta serie 3 '98->'04 (E46)
163 749	BMW	Fijac. moldura vierteaguas puerta serie 3 '98->'04 (E46)
	BMW	Fijac. moldura vierteaguas puerta serie 3 '98->'04 (E46)
163 750	BMW	Fijac. panel puerta s.1 (E82), s.3 (E46, E90/91/92/93), s.5 (E60N/61N), serie 7, X1, X3 (E83, F25), X5 (E53), X6
	Mini	Fijac. moldura parabrisas R58
163 751	Mini	Fijac. panel puerta R50, R52, R53, R55, R56, R60, fijac. pilar C F56 '14->
	BMW	Fijac. panel puerta serie 5 (E39), Z8 (E52)
163 752	BMW	Fijac. panel puerta serie 1 (E88), serie 3 (E36 Cabrio, E46, E90/91/92/93), serie 5 (E60/E61), serie 6 (E63/E64), X1, X3 (E83, F25), X5 (E53, E70), X6
	Mini	Fijac. panel puerta R50, R52, R53 (ver BMW)
163 753	BMW	Fijac. panel puerta serie 5 (F07/F10/F11), serie 6 (F12), serie 7 (F01/F02), fijac. tapizados maletero X5 (E70)
	Mini	Fijac. mold. lateral parabrisas R50, R52, R53, R55, R56, R57, fij. panel puerta trasero R55, fijac. moldura parabrisas R58



INDICE REFERENCIAS

FAM. 0300	Marca	Descripción
163 754	Ford	Fijac. panel puerta Fiesta '08->, Kuga, fij. revestimientos interiores Fiesta '08, Mondeo '07, S-Max
	Mini	Fijac. tapizados maletero R50, R52, R53, R56
	Rover	Fijac. panel puerta Discovery '05->'09 y Range Rover Sport '05->'10 y fijac. tapizados interiores Discovery 3 y 4, Evoque, Freelander '07, Range Rover '05->'12 y Range Rover Sport '05->
	Volvo	Fijac. panel puerta y tapizados interiores C30, C70, S40 '04, S60, S80, V40 '13->, V50, V60 '11->, V70 '00, XC60, XC70, XC90
163 755	VAG	Fijac. cubierta carril guía puerta corredera VW Transporter '09->, LT '09
163 756	universal	
	VAG	Remache fijac. aletas Audi A1, A4 '08-> y fijac. puerta Audi A4 '08->
163 757	universal	
	VAG	Remache fijac. cubierta parachoques Audi A4 '08->, A5, Q5 '09->
163 758	Mini	Fijac. moldura cristal lateral trasero R50, R53
163 759	Mini	Fijac. moldura cristal lateral trasero R50, R53
163 760	VAG	Fijac. tapizados portón trasero Audi Q5, Alhambra '09, VW Polo '09, Sharan '09, Touran '09, LT '09, Transporter '09
163 761	Volvo	Fijac. moldura lateral parabrisas (parte inferior) S80 '98->'06 (Eurocode 8828ASCS)
163 762	Volvo	Fijac. moldura lateral parabrisas (parte media) S80 '98->'06 (Eurocode 8828ASCS7B)
163 763	Volvo	Fijac. moldura lateral parabrisas (parte superior) S80 '98->'06 (Eurocode 8828ASCS)
163 764	Volvo	Fijac. moldura parabrisas (parte trasera) S80 '98->'06 (Eurocode 8828BSCSS)
163 765	Ford	Fijac. varilla soporte capó Galaxy '06->, Mondeo '07->, S-Max, Transit '06->
163 766	Ford	Fijac. pilotos traseros C-Max '03->'11, Fiesta '02 y '08->, Focus '98 y '05->, Kuga, Mondeo '00->'07
	universal	
163 767	Ford	Taco fijac. parachoques trasero Ka '96->, fijac. tapizados puerta Focus '04->, C-Max '03->'07
163 768	Mercedes	Fijac. moldura lateral portón trasero Vito (W638)
163 770	BMW	Fijac. moldura talonera puerta serie 5 (E34 / E39)
163 771	Mercedes	Fijac. tapizados portón trasero Vito (W638)
163 772	BMW	Fijac. moldura puerta-techo serie 1 (E81/82), serie 3 (E46, E92/93), serie 5 (F07), serie 6 (E63/64), serie 7 (E38), X5
	BMW	Fijac. panel puerta serie 3 (E36 Cabrio, E46), serie 7 (E32/E38)
163 773	Mercedes	Fijac. tapizados interiores laterales Sprinter, fij. tapizados traseros Clase S (W221)
	BMW	Fijac. moldura talonera serie 3 '04-> (E90 / E91)
163 775	BMW	Fij. moldura lateral parabrisas (parte inferior) serie 7 '07-> (F01/02/03/04) (Eurocode 2457ASCSDS)
163 776	BMW	Fij. moldura parabrisas (parte media) y luneta tras. s.7 (F01/02/03/04) (Eurocode 2457ASCSDS1B)
163 777	BMW	Fij. moldura techo - parabrisas serie 7 '07-> (F01 / F02 / F03 / F04)
163 778	Mercedes	Fijac. talonera puerta W124
163 779	Mercedes	Fijac. talonera puerta Clase C (W203) y otros usos SLK (W170 / W171)
	universal	
163 780	Mercedes	Remache fijac. moldura talonera Clase C (W203), Clase E (W211), Clase S (W220)
	Mercedes	Fijac. moldura Clase C (W201)
163 782	Mercedes	Fijac. parrilla radiador Clase C (W203), Clase E (W210)
163 783	Mercedes	Fijac. molduras techo-parabrisas Clase C '00->'07 (W203) (Eurocode 5352ASCCD)
163 784	Mercedes	Fijac. molduras parabrisas Vaneo '02-> (Eurocode 5436ASCVS)
163 785	Mercedes	Fijac. moldura lateral Clase C (W203)



INDICE REFERENCIAS

FAM. 0300	Marca	Descripción
163 786	Mercedes	Fijac. revestimientos interiores W124, W126, W140, W201, W202, W210
163 787	Mercedes	Fijac. tapizados interiores W124, W126, W140, W201, W202, W210
163 788	Mercedes	Fijac. tapizados puerta Vito
163 789	Mercedes	Fijac. tapizados maletero Clase E (W210, W220, W221, W230)
163 790	Mercedes	Fijac. panel puerta y revestimientos interiores Clase A (W169), Clase B (W245), Clase C (W204)
163 791	Mercedes	Fijac. revestimientos interiores pilar D Clase C (W204), fij. panel puerta Clase E (W212), ML
	universal	
163 792	Mercedes	Remache fijac. rejilla calandra Clase C (W201), Clase S (W221), fijac. cristal posterior CLK (W209), fijac. moldura portón trasero W124
	universal	
163 793	Mercedes	Remache fijac. soporte radiador y otros usos - varios modelos -
	universal	
163 794	VAG	Remache fijac. pasoruada, moldura estribera y rejilla parabrisas "torpedo" Seat Ibiza '09->
163 795	Mercedes	Fijac. panel puerta Mercedes ML (W163)
163 796	BMW	Fij. moldura lateral parabrisas serie 5 '09-> (F10 / F11) (Eurocode 2459ASCSDS)
163 797	BMW	Fij. moldura parabrisas - techo serie 5 '09-> (F10 / F11)
163 798	Opel	Fijac. moldura talonera puerta Corsa A y B, Kadett E, Vectra A
163 799	Opel	Fijac. moldura portón trasero y luneta trasera Vectra B Familiar, fijac. moldura lateral Omega A
163 800	Opel	Fijac. moldura lateral techo Astra H, Zafira B
	BMW	Fijac. junta moldura puerta serie 3 '04-> (E90 / E91)
163 801	BMW	Fijac. junta moldura puerta serie 3 '04-> (E90 / E91)
	universal	
163 802	Honda	Fijac. parachoques Accord '98->'07, Civic '01->'05, CR-V '02, Element, Jazz, Insight, Odyssey
	Nissan	Fijac. parachoques Almera '00, Almera Tino, Micra, Murano, Navara, Note, Pathfinder, Patrol, Primera, Qashqai, Sunny, Teana, Terrano, Tiida, X-Trail, 350Z
163 803	Mazda	Fijac. moldura parabrisas Mazda Demio '98->'03 (Eurocode 5157ASCVB)
163 804	Honda	Fijac. talonera puerta Accord '90->'07, Civic '92->'00, CR-V '97->'01
163 805	Honda	Fijac. panel puerta y tapizados int. Accord '94->'02, Civic '02->'05, CRV '97->'01
163 806	Nissan	Fijac. panel puerta y tapizados interiores Almera, Almera Tino, Maxima, Micra, Navara, Qashqai, Patrol, Primera, Sunny, Terrano, X-Trail, 350Z
163 807	Nissan	Fijac. panel puerta y tapizados interiores Micra C+C '05->, Murano, Primera '01->, Qashqai, Sunny, Teana, X-Trail, 350Z
	Fiat	Fijac. rejilla parabrisas "torpedo" Alfa Romeo 147 y GT (Eurocode 2037ASCHB)
163 808	Fiat	Fijac. rejilla parabrisas "torpedo" Alfa Romeo 147 y GT (Eurocode 2037ASCHB)
163 809	BMW	Fijac. moldura techo serie 5 '02-> (E60 / E60N)
	universal	
163 810	Ford	Remache fijac. panel puerta Fiesta '08->, fij. tapizados interiores C-Max
	VAG	Remache fijac. parachoque trasero Audi A5, Q5 '09->, Seat Ibiza '09->, fij. aleta delantera Touareg
163 811	Volvo	Remache fijac. talonera puerta C30, S40 '04->, V50, V70 '08->, XC60 '09->, XC70 '08->
163 812	Honda	Fijac. junta goma puerta Accord '98->'07, Civic '01->'05
	universal	
163 813	Honda	Fijac. moldura talonera puerta CR-V '97->'06



INDICE REFERENCIAS

FAM. 0300	Marca	Descripción
163 814	universal	
	Chevrolet	Fijac. varios usos -varios modelos-
	Fiat	Fijac. talonera puerta Fiat Sedici '06->
	Suzuki	Fijac. talonera puerta Aerio/Liana '02->, Swift, SX4 '06->
163 815	universal	
	Nissan	Fijac. parachoques Sunny, Terrano II, X-Trail '07->
163 816	BMW	Fijac. moldura techo serie 5 Touring '05-> (E61/E61N), X3 '09-> (F25), X5 '07-> (E70/E70N), X6
163 817	BMW	Fijac. moldura techo serie 5 Touring '05-> (E61/E61N), X5 '07-> (E70/E70N)
163 818	BMW	Fijac. revestimientos interiores serie 1 (E81/82/87), serie 3 (E90/91/92), serie 5 (F07/10/11), serie 7 (F01/02/03), X1
163 819	BMW	Fijac. moldura talonera serie 3 Coupé / Cabrio '06-> (E92 / E93)
163 820	BMW	Fijac. moldura pasoruada X3 (E83), fijac. talonera serie 3 (E30/E46), serie 5 (E28), X3
163 821	BMW	Fijac. moldura talonera serie 3 '04-> (E90 / E91)
163 822	BMW	Fijac. faldón entrada puerta serie 3 Coupé (E92)
163 823	BMW	Fijac. tapizados puerta X3 '09->
	Mini	Fijac. agarradero exterior portón trasero R56 / R57
163 824	VAG	Fijac. juntas estanqueidad puertas VW Golf V y VI, Jetta '09->
163 825	BMW	Fijac. moldura protección entrada puerta trasera serie 1 (E81/E82/E87), serie 3 (E90/91/93), serie 5 (E60/E61), serie 6 (E63/E64), x3 '09-> (F25), X5 '07-> (E70), X6
163 826	BMW	Fijac. moldura exterior pilar B serie 1 (E87/E87N)
	Mini	Fijac. moldura exterior pilar B Mini Countryman R60
163 827	universal	
	BMW	Fijac. torpedo parabrisas serie 5 '10-> (F07/10/11)
	BMW	Fijac. parachoques delantero serie 5 (E34), tapiz. maletero serie 3 (E36), serie 5 (E60), X5 (E53) '00->'07, fijac. insonorizante motor serie 1 (F20/21), serie 3 (E46/E90/91/92/F30/31/32/33/34)
	Mini	Fijac. insonorizante motor R50, R52, R53, R55, R56, R60 y R61
163 828	BMW	Fijac. moldura pasoruada X3 '09-> (F25), fijac. talonera puerta serie 7 (E38)
163 829	BMW	Fijac. panel puerta serie 3 (E90N/E91N)
163 830	Dacia	Fijac. aleta trasera Duster
	Fiat	Fijac. pasoruada Fiat 500 '07->
	Ford	Fijac. rejilla parabrisas Ka '08->
	Mercedes	Fijac. talonera y bajos carrocería varios modelos
	Smart	Fijac. bajos carrocería Smart ForTwo
163 831	Mercedes	Fijac. tapizados interiores Clase A (W169), Clase B (W245) (Eurocode 5358BSCH)
163 832	Mitsubishi	Fijac. moldura parabrisas Colt '92->'02, Lancer '91->'00, Mirage (Eurocode 5641ASCHS)
163 833	Mercedes	Fijac. panel trasero techo Vito (W638)
163 834	VAG	Fijac. junta goma puerta Seat Ibiza '02->, León '99->'05, Toledo '99->'05
163 835	VAG	Fijac. junta goma puerta Seat Cordoba '03->, Ibiza '02->, León '99->'05, Toledo '99->'05, y fij. junta capó Seat León '13
163 836	Mini	Fijac. moldura lateral techo (parte delantera) R50, R53, 55 (Eurocode 2455ASCHD)
163 837	universal	
	Fiat	Fijac. rejilla parabrisas "torpedo" Fiat Stilo '01-> (Eurocode 3355ASCHB)
	Fiat	Fijac. rejilla parabrisas "torpedo" Fiat Stilo '01->



INDICE REFERENCIAS

FAM. 0300	Marca	Descripción
163 838	Volvo	Fijac. moldura lateral parabrisas (parte inferior) S60 '11->, V60 (Eurocode 8841ASCBS)
163 839	Volvo	Fijac. moldura lateral parabrisas S60 '11->, V60 (Eurocode 8841ASCSS)
163 840	BMW	Fijac. faldón entrada puerta serie 1 (E82/88), serie 3 (E36/E46), s.5 (E34/E39/E60/61/F10/F11), serie 6 (E63/64), serie 7 (E38/E65/66/67/68/F01/02/03), X1, Z3, Z4
163 841	BMW	Fijac. faldón puerta serie 3 (E21/E30/E36)
163 842	BMW	Fijac. moldura talonera s.3 (E30), s.5 (E34), s.7 (E32/E38), fij. moldura marco puerta serie 5 (E39)
163 843	BMW	Fijac. panel puerta serie 3 (E46), fijac. revestimientos interiores serie 1 (E81/82/87/88), serie 3 (E90/91/92/93), s.5 (F07/10/11), s.7 (F01/02/03/04), X1, X3 (F25), X5 (E70), X6
	Mini	Fijac. tapizados interiores techo R50/53, fijac. cubierta superior parabrisas R52, fijac. talonera puerta F56 '14->, fijac. revestimientos interiores R55/56/60
163 845	Mini	Fijac. moldura ventana puertas R50, R52, R53 y R55
163 846	Mini	Fijac. moldura pasoruada trasero R50, R52 y R53
163 847	Mini	Fijac. soporte matrícula trasero R50, R52 y R53
163 848	BMW	Fijac. soporte matrícula trasero serie 3 (E46), serie 5 (E60), X5 (E53)
	Mini	Fijac. soporte matrícula trasero R50, R52, R53, R56, y R57
163 849	BMW	Fijac. agarradero tapa maletero serie 3 (E46)
	Mini	Fijac. spoiler trasero R56 (ver BMW)
163 850	VAG	Fijac. moldura lateral parabrisas Seat Ibiza '09-> (Eurocode 7614ASCHS)
163 851	Opel	Fijac. moldura techo-parabrisas Zafira A '99->'04
163 852	Fiat	Fijac. moldura inferior parabrisas Sedici '06-> (Eurocode 6291ASCV)
	Opel	Fijac. moldura inferior parabrisas Agila '00->'07 y '08-> (Eurocode 6291ASCV)
	Suzuki	Fijac. moldura inferior parabrisas Swift, SX4 '06-> (Eurocode 6291ASCV)
163 853	Mercedes	Fijac. moldura lateral izquierda (parte trasera) 124, 200, 250, 300, 320
163 854	Mercedes	Fijac. moldura lateral derecha (parte trasera) 124, 200, 250, 300, 320
163 855	Mercedes	Fijac. gato talonera puerta Clase C (W203) '00->'07
163 856	Mercedes	Fijac. gato talonera puerta Clase E (W210) '95->'02 y Clase S (W220) '99->'05
163 857	Mercedes	Boca fijac. molduras laterales Mercedes -varios modelos-
163 858	Renault	Fijac. soporte rejilla calandra Megane III '09->, Fluence
	Renault	Fijac. tapizados interiores - varios modelos -
163 859	universal	
	Toyota	Fijac. rejilla parabrisas "torpedo" Avensis '97->'03 (Eurocode 8305ASCH6B)
	Toyota	Fijac. talonera puerta 4Runner '06->, fijación rejilla parabrisas "torpedo" Avensis '97->'03 (Eurocode 8305ASCH6B)
163 860	Mini	Fijac. moldura aletines pasoruada y parachoques Mini Cooper Cabrio R57 08/'10->
163 861	Mercedes	Fijac. panel puerta - varios modelos - y camiones
163 862	BMW	Fijac. moldura talonera serie 5 '02-> (E60 / E61)
163 863	BMW	Fij. moldura techo - parabrisas serie 1 (E81/E82), serie 3 Coupé '06-> (E92), serie5 Gran Turismo (F07), serie 6
163 864	Mini	Fijac. moldura adorno frontal capó R55, R56 y R57
163 865	BMW	Fijac. moldura techo serie 5 Touring '05-> (E61/E61N)
163 866	Suzuki	Fijac. moldura lateral parabrisas Swift '05-> (Eurocode 8031ASCHS / 8032ASCHS)
163 867	Fiat	Fijac. soporte inferior parabrisas Ducato II '02->'06
	PSA	Base soporte parabrisas "torpedo" Jumper II, Boxer II '01->'06



INDICE REFERENCIAS

FAM. 0300	Marca	Descripción
163 868	Renault	Fijac. moldura lateral parabrisas Vel Satis (Eurocode 7250ASCHS1B)
163 869	PSA	Fijac. varilla capó C4 '10->, P-206, P-308
163 870	PSA	Fijac. moldura lateral puerta P-308
163 871	PSA	Fijac. moldura aleta delantera C3 Picasso
163 872	PSA	Fijac. moldura lateral puerta C4 Picasso, P-207 Coupé / Cabrio
163 874	PSA	Fijac. moldura lateral puerta Citroën C6
163 875	VAG	Fijac. junta goma puerta Seat León '13, Skoda Octavia '04, Roomster, VW Golf VI y VII, Passat '11, Scirocco '08, y fijac. guía ventanilla VW Passat '11
163 876	Chevrolet	Fijac. tapizados interiores Camaro, Caprice, Volt, Pontiac
	Opel	Fijac. moldura parabrisas Combo, Meriva A '03->'10
	Opel	Fij. tapiz. interiores Antara '12, Astra J, Corsa D, Insignia, Meriva B, Signum, Vectra C, Zafira B y C, fijac. talonera puerta Corsa C y D, Meriva A '03, Vectra C, Signum, Zafira B '05, fijac. moldura anagrama trasero Zafira C '12->
	PSA	Fijac. tapizados portón trasero Citroën DS4 y Peugeot 308 break
	Renault	Fijac. tapizados interiores - varios modelos -
163 877	VAG	Fijac. panel puerta VW Golf V, Golf Plus, Jetta '06
163 878	universal	
	Ford	Fijac. soporte parachoques trasero Galaxy '06->, S-Max '06
163 879	universal	
	Renault	Fijac. tapizados interiores Master III '10->
163 880	PSA	Fijac. tapa cubremotor Berlingo '09, C3 '09->, C4 '10->, C4 Picasso, C5 '08->, DS3, DS4, P-206, P-207, P-307, P-308, P-3008, P-5008, Expert III, Partner '09, fijac. pasoruada P-308 '14->
163 881	universal	
	Dacia	Fijac. moldura inferior puerta Sandero II '13->
	PSA	Fijac. parachoques delantero C3 '01->'05, fij. tapizados interiores Berlingo '09, C5 '08, DS4, P-207, P-308, P-407, P-508, P-3008, Partner Tepee, RCZ
	Renault	Taco fijac. moldura parabrisas Scenic III, y fij. panel puerta Captur
163 882	universal	
	PSA	Taco fijac. panel P-208, P-301, P-308 '14->, P-5008
	Renault	Taco fijac. inferior moldura parabrisas Megane III Coupé, fijac. panel puerta Clio IV, Megane III, Scenic III
163 883	universal	
	Dacia	Fijac. panel puerta Lodgy
	PSA	Taco fijac. tapizados interiores P-3008, P-5008I
	Renault	Taco fijac. tapizados interiores Laguna III, Megane III, Scenic III
163 884	VAG	Boca fijac. moldura talonera puerta VW Golf V, Passat '05, Scirocco '08, Tiguan
163 885	PSA	Fijac. varilla capó Evasion, Jumpy I y II, Expert I y II
	Renault	Fijac. varilla capó Laguna
163 886	universal	
	PSA	Fijac. pasoruada Berlingo, Saxo, Xsara II, Partner, fij. parachoque trasero C3, fijac. aletas traseras Saxo, P-106, fijac. tapizados alfombra maletero C4, Saxo, P-106, P-206, P-207, P-307, P-406
	universal	
163 887	PSA	Fijac. panel puertas traseras P-106 restyl., fijac. tapizados alfombra maletero P-406, fijac. parachoque trasero P-605
163 888	PSA	Fijac. varilla capó C3 Picasso, C8, Jumpy III, Xantia, P-206, P-207, P-307, P-807, Expert III



INDICE REFERENCIAS

FAM. 0300	Marca	Descripción
163 889	universal	
	Mercedes	Remache fijac. varios usos Clase C (W202), Clase M (W163)
163 890	Opel	Fijac. parachoques Vectra C, Zafira B '05->, fijac. moldura pasoruada Astra F, G y H, Corsa D, Vectra B
	universal	
163 891	Volvo	Remache fijac. parachoques delantero XC60, XC70, fijac. tapizados interiores S40 '04->
163 892	Renault	Fijac. tapizados puerta Trafic II
163 893	Hyundai	Fijación moldura lateral Hyundai Accent, Atos, Coupé, H-100, i10, ix35, Matrix, Santa Fe, Tucson, Kia Picanto, Sorento, Sportage
163 894	VAG	Fijac. pasoruadas Audi A1, A4 '08, A6 '05, A7, Q5
163 895	universal	
	Toyota	Fijac. parachoques trasero Corolla '01->'06, fijac. bajos carrocería Prius '03->'09
163 896	Toyota	Fijac. parachoques trasero Yaris '99->'05
163 897	Honda	Fijac. insonorizante capó Accord '03->, Civic '06->, CR-V, Insight '10->, Jazz
163 898	Opel	Fijac. pasoruada Corsa C, fijac. parachoque Vectra B, Zafira A, fij. tapizados y otros usos interiores Astra G y H, Meriva, Omega B, fijac. faro antiniebla Corsa C, Meriva, Omega B, Vectra B, Zafira A
163 899	Chevrolet	Fijac. parachoque delantero Cruze
	Opel	Fijac. pasoruada y parachoques Astra H, Corsa D, Insignia, Meriva A y B, Signum, Vectra C, Zafira B, fijac. antiniebla delantero Astra H, Insignia, Vectra C, Zafira B, fijac. antiniebla trasero Corsa C
163 900	Chevrolet	Fijac. tapizados interiores Camaro, Caprice, Cruze, Volt, Pontiac
	Opel	Fijac. moldura techo Zafira B (Eurocode 6290ASCH)
	Opel	Fijac. tapizados interiores pilar A y entrada a puerta Astra H, Corsa C y D, Insignia, Meriva, Signum, Vectra C, Zafira B
163 901	Ford	Fijac. junta panel puerta trasera Focus '98->'04
163 902	Opel	Fijac. moldura techo Meriva A '03->'10, Signum, Vectra C
163 903	Opel	Fijac. tapiz. alfombras piso Astra G, Calibra, Combo, Corsa A, Kadett E, Omega A y B, Vectra A y B, fijac. ajuste respaldo Agila, Astra H, Corsa C, Meriva, Zafira B
163 904	universal	
	VAG	Remache fijac. aleta delantera Seat Ibiza '09->
	Volvo	Remache fijac. parachoques S40 / V40 '96->'04, fijac. talonera puerta S80 '07->
163 905	Nissan	Fijac. rejilla parabrisas "torpedo" Primera P11 y P12 '96-> y varios usos Micra '92->'02 (Eurocode 5981ASCS)
163 906	PSA	Fijac. panel puerta Citroën Jumpy III, Peugeot 207, Expert III
163 907	Dacia	Fijac. pasoruada trasero Duster, fijac. insonorizante y tapizados interiores Duster, Logan, Lodgy, Sandero 1 y 2
	Renault	Fijac. insonorizantes y tapizados interiores Clio III, Fluence, Latitude, Master III, Megane II y III, Scenic II y III, Twingo II, fijac. vierteaguas lateral Fluence, Megane III, fijac. rejilla calandra Twingo II '07->
163 908	Mercedes	Fijac. parachoque Clase C (W203/W204), Clase E (W211) y W164
163 909	Mercedes	Fijac. moldura techo-parabrisas Clase C '07-> (W204) (Eurocode 5364ASCSDS)
163 910	Mercedes	Fijac. moldura techo-parabrisas Clase E '02->'08 (W211) (Eurocode 5347ASCS)
163 911	universal	
	Opel	Fijac. tapizados interiores Astra H, Zafira B '05->
163 912	Opel	Fijac. moldura lateral puerta, talonera puerta y aletas Corsa B, Signum, Omega B, Vectra B, Zafira A
163 913	PSA	Fijac. rejilla parabrisas "torpedo" C-Crosser, P-4007
163 914	PSA	Fijac. retrovisor Berlingo, Partner, fijac. cablería bajo capó y otros usos - varios modelos -
	Renault	Fijac. cablería - varios modelos -
163 915	Ford	Fijac. aletas Ka '96->, Street Ka



INDICE REFERENCIAS

FAM. 0300	Marca	Descripción
163 915	Ford	Fijac. rejilla parabrisas "torpedo" Galaxy '94->'06 (Eurocode 3550ASCVS)
163 916	Opel	Fijac. placa matrícula trasera Opel Astra F, Calibra, Corsa A, Euromidi, Frontera A, Kadett E, Omega A, Vectra A
163 917	VAG	Fijac. moldura lateral puerta Seat Alhambra '10, VW Scirocco '09, Sharan '10, Tiguan, fijac. aletas VW Tiguan, fijac. talonera puerta y soporte cubierta portón trasero VW Passat '06
163 918	universal	
	Ford	Fijac. pasoruera trasero Fiesta '08->
163 919	Opel	Fijac. insonorizante capó Astra G, Combo, Corsa B y C, Insignia, Tigra B, Vectra B y C, Zafira A
163 920	Fiat	Fijac. rejilla parabrisas "torpedo" Alfa Romeo 159, Brera, Fiat Ducato III '06->
	PSA	Base soporte parabrisas "torpedo" Jumper III, Boxer III '06->
163 921	Ford	Taco fijac. moldura inferior puerta Focus '04, C-Max '03->'11, fijac. moldura lateral Focus Berlina '98
163 922	universal	
	BMW	Fijac. revestim. maletero s.1 (E82/E88), s.5 (E60/60N y F07), s.6 (E63/64), X5 (E70), X6, Z4 (E89)
163 923	universal	
	BMW	Fijac. revestim. maletero s.1 (E88), s.3 (E46 y E90/E92/E93), s.6 (E61/E61N), s.7 (F01/02/03/04)
163 924	universal	
	Mercedes	Remache fijac. protectores bajos ML (W163/W164) GL, CL, Clase S y R (W221/W251)
	VAG	Remache fijac. bajos carrocería Audi A2
163 925	universal	
	Mercedes	Remache fijac. soporte radiador y otros usos - varios modelos -
163 926	universal	
	Mercedes	Remache fijac. panel puerta, tapizados interiores y otros usos - varios modelos -
	Opel	Fijac. varios usos - varios modelos -
	Renault	Remache fijac. varios usos - varios modelos -
	Volvo	Remache fijac. varios usos - varios modelos -
163 927	universal	
	Mercedes	Remache fijac. panel puerta, tapizados interiores y otros usos - varios modelos -
163 928	BMW	Fijac. faldón entrada puerta serie 3 (E46/E90/E91/E93), serie 5 (E60/E61/F07)
163 929	VAG	Fijac. moldura talonera puerta Audi Q3, Q5 '09->
163 930	Opel	Fijac. moldura techo Corsa C '00->'06
163 931	Toyota	Fijac. moldura portón trasero Rav4 '05->, fij. aleta delantera y moldura lateral Land Cruiser '02->'09
163 932	Toyota	Fijac. moldura aleta trasera Rav4 '94->'00
163 933	Toyota	Fijac. moldura lateral Land Cruiser '02->'09
163 934	Toyota	Fijac. moldura lateral Land Cruiser '02->'09
163 935	Toyota	Fijac. moldura aleta trasera Land Cruiser '02->'09
163 936	Toyota	Fijac. moldura aleta trasera Land Cruiser '02->'09
163 937	Toyota	Fijac. moldura aleta trasera derecha Land Cruiser '02->'09
163 938	Toyota	Fijac. moldura aleta trasera izquierda Land Cruiser '02->'09
163 939	Toyota	Fijac. moldura aleta trasera derecha Land Cruiser '02->'09
163 940	Toyota	Fijac. moldura aleta trasera izquierda Land Cruiser '02->'09
163 941	Toyota	Fijac. moldura aletas Hi-Lux '97->'05 y '05->, fijac. moldura lateral y aletas 4Runner '95->'02
163 942	Toyota	Fijac. moldura aletas Hi-Lux '97->'05 y '05->, fijac. moldura lateral y aletas 4Runner '95->'02



INDICE REFERENCIAS

FAM. 0300	Marca	Descripción
163 943	Mercedes	Fij. mold. techo-parabrisas Clase A '04-> (W169) y Clase B '05-> (W245) (Eurocode 5358ASCHDS)
163 944	PSA	Fijac. moldura portón trasero C4 '04->'10, C5 '04->'08
163 945	universal	
	Fiat	Fijación pasoruada Grande Punto, fij. toma de aire Bravo '07->, fijac. tapizados interiores Punto
163 946	Fiat	Soporte parachoque delantero derecho Fiat 500 '07->
163 947	Fiat	Soporte parachoque delantero izquierdo Fiat 500 '07->
163 948	Renault	Fijac. moldura lateral parabrisas Megane III Coupé / Cabrio '10->
163 949	BMW	Fijac. moldura techo X1 (E84)
163 950	BMW	Fijac. junta puertas X5 '00->'07 (E53)
	BMW	Fijac. junta puertas X5 '00->'07 (E53)
163 951	BMW	Fijac. junta puertas y junta frontal capó X5 '00->'07 (E53), serie 7 '02-> (E65/E66/E67/E68)
	BMW	Fijac. junta puertas y junta frontal capó X5 '00->'07 (E53), serie 7 '02-> (E65/E66/E67/E68)
163 952	BMW	Fij. moldura lateral parabrisas X3 '10-> (F25), fij. mold luneta trasera - techo s.7 (F01/F02/F04)
163 953	Renault	Fijac. moldura techo Scenic II
163 954	VAG	Fijac. panel puerta Audi A6 '05->
163 955	VAG	Fijac. talonera puerta Audi A3 '97->'03, Seat Alhambra '00, VW Sharan '00, fijac. revestimientos interiores Altea, Ibiza / Cordoba '02, Leon '99, Toledo '99, Skoda Fabia '00, Octavia '04, VW Caddy '04, Golf IV y V, Jetta, Lupo, Passat '97->'10, Polo '02, Tiguan, Touran, Touareg, Transporter '03 (monta junto con 163956)
163 956	VAG	Fijac. talonera puerta Seat Alhambra '00, VW Sharan '00, fijac. revestimientos interiores Seat Altea, Arosa, Cordoba/Ibiza '02, Leon '99, Toledo '99, Skoda Fabia, Octavia '04, Superb, VW Caddy '04, Golf IV y V, Jetta, Lupo, Passat '97->'10, Polo '02, Tiguan, Touran, Touareg, Transporter '03 (monta junto con 163955)
163 957	Honda	Fijac. moldura lateral parabrisas Civic '06->, FR-V (Eurocode 3992ASCV2B)
163 958	Volvo	Fijac. moldura parabrisas -techo S60 '01->'09, S80 '98->'06, V70 '00->'08, V70XC (Eurocode 8829ASCES2B)
163 959	Renault	Kit fijac. moldura parabrisas Laguna '94->'01 (contiene 11 piezas) (Eurocode 7237AKCH)
163 960	Ford	Fijac. revestimientos interiores puerta Fiesta '02->'08
	universal	
163 961	VAG	Remache fijac. talonera puerta Audi A1, fijac. pasoruada Skoda Octavia '04, fijac. parachoques Skoda Roomster '06, fijac. tapizados interiores Audi A2, Seat Arosa y otros usos -varios modelos-
163 962	Hyundai	Fijac. tapizados puerta Hyundai Accent '99, Elantra '00, Genesis, Getz, H1, Santa Fe, Sonata, Tucson, XG300/350, Kia Cerato, Carnival, Picanto, Sorento, Sportage, K2500/2700
	universal	
163 963	Fiat	Fijac. parrilla radiador Ducato '06->
	PSA	Remache fijac. parrilla radiador Boxer III '06->, Jumper III '06->
	universal	
163 964	Fiat	Fijación tapizados interiores Alfa Romeo Mito, Fiat Dobló, Qubo
163 965	Fiat	Fijac. junta puerta corredera Dobló '09->, fij. tapizados interiores Fiat Dobló '00->
163 966	Fiat	Fijac. revestimientos interiores y tapizados Alfa Romeo 147, 156, GT, Fiat 500 '07, Grande Punto, Punto EVO, Stilo, Lancia Delta
163 967	Fiat	Fijac. tapizados interiores Fiat Grande Punto
163 968	Fiat	Fijac. panel puerta y tapizados Fiat Qubo
	universal	
163 969	Fiat	Fij. tapizados y protecciones interiores Alfa R. Mito, Fiat Idea, Punto '99 y '03, Lancia Musa, Ypsilon



INDICE REFERENCIAS

FAM. 0300	Marca	Descripción
163 970	Fiat	Fijac. pasoruada Alfa Romeo 159, Brera, Mito, Fiat Croma '05, Dobló '00->'09, Ducato '06, Grande Punto, Linea, Punto EVO, Qubo
163 971	universal	
	Fiat	Fijac. parachoques y tapizados interiores Fiat Ducato '06->, Palio, Siena, Lancia Kappa
163 972	universal	
	Fiat	Fijac. tapizados interiores Fiat Dobló '00->'09, Ducato '06->
163 973	universal	
	Fiat	Fijac. pasoruada y bajos carrocería Alfa Romeo Mito, Fiat Grande Punto, Punto EVO
163 974	VAG	Fijac. revestimientos interiores laterales traseros Seat Ibiza '09->
163 975	VAG	Fijac. soporte matrícula Audi A6 '10->, A7 '10->
163 976	Hyundai	Fijac. insonorizante capó Hyundai Accent '06, Azera '05, Coupé, Elantra, Entourage, Genesis, Santa Fe '03, Sonata, Tucson '04, ix55 (Veracruz) '06, XG300/350, Kia Sorento, Sportage
163 977	Mitsubishi	Fijac. moldura parabrisas Colt '92->'02, Lancer '91->'00, Mirage (Eurocode 5642ASCHS)
163 978	Renault	Kit fijac. moldura parabrisas Scenic III '10-> (contiene 7 piezas) (Eurocode 7280AKCMS2F)
163 979	PSA	Fijac. moldura techo P-407 coupé
163 980	PSA	Fijac. moldura techo Peugeot P-308
163 981	universal	
	Lexus	Fijac. parachoques trasero LS400
	PSA	Fijac. deflector aire delantero C1, P-107
163 982	Toyota	Fijac. pasoruada delantero Avensis '03->'08, fijac. deflector aire delantero Aygo
	Lexus	Fijac. moldura inferior puerta LS400, LS430, GS300
163 983	BMW	Fijac. moldura inferior puerta Avensis '03->'08
163 984	BMW	Kit soporte cristal elevalunas delantero serie 3 (E46) COMPACT
163 985	BMW	Soporte cristal elevalunas trasero derecho serie 1 y serie 3 (E90/91) '05->, X1
163 986	BMW	Soporte cristal elevalunas trasero izquierdo serie 1 y serie 3 (E90/91) '05->, X1
163 987	BMW	Soporte cristal elevalunas trasero derecho X3 '03->
163 988	BMW	Soporte cristal elevalunas trasero izquierdo X3 '03->
163 989	Ford	Soporte cristal elevalunas delantero derecho Transit Connect '02->
163 990	Ford	Soporte cristal elevalunas delantero izquierdo Transit Connect '02->
163 991	VAG	Soporte cristal elevalunas trasero derecho Audi A4 '01->'08, Seat Exeo
163 992	VAG	Soporte cristal elevalunas trasero izquierdo Audi A4 '01->'08, Seat Exeo
163 993	VAG	Soporte cristal elevalunas trasero derecho Audi A6 '04->'09
163 994	VAG	Soporte cristal elevalunas trasero izquierdo Audi A6 '04->'09
163 995	VAG	Kit reparación elevalunas delantero derecho Skoda Octavia '04->
163 996	VAG	Kit reparación elevalunas delantero izquierdo Skoda Octavia '04->
163 997	VAG	Kit reparación elevalunas delantero VW Golf V '04->'08
163 998	VAG	Kit reparación elevalunas delantero VW Golf VI '08->'12
163 999	VAG	Soporte cristal elevalunas trasero derecho VW Golf V '04->'08
164 000	VAG	Soporte cristal elevalunas trasero izquierdo VW Golf V '04->'08
164 001	VAG	Soporte cristal elevalunas delantero Audi A3 '04->
164 001	VAG	Soporte cristal elevalunas delantero Audi A3 '04->



INDICE REFERENCIAS

FAM. 0300	Marca	Descripción
164 002	Renault	Soporte cristal elevallunas delantero Clio II '98->'05
164 003	Renault	Kit soporte cristal elevallunas delantero Clio III '05->'12
164 004	PSA	Kit soporte cristal elevallunas delantero P-307
164 005	PSA	Kit soporte cristal elevallunas delantero C5 '01->'08
164 006	PSA	Soporte cristal elevallunas trasero derecho P-407
164 007	PSA	Soporte cristal elevallunas trasero izquierdo P-407
164 008	Fiat	Soporte cristal elevallunas delantero derecho Ducato '94->'06
	Opel	Soporte cristal elevallunas derecho Meriva
	PSA	Soporte cristal elevallunas derecho Jumper, Boxer '94->'06
164 009	Fiat	Soporte cristal elevallunas delantero izquierdo Ducato '94->'06
	Opel	Soporte cristal elevallunas izquierdo Meriva
	PSA	Soporte cristal elevallunas izquierdo Jumper, Boxer '94->'06
164 010	Fiat	Soporte cristal elevallunas delantero derecho Ducato '06->, Linea, Palio
	PSA	Soporte cristal elevallunas derecho Jumper, Boxer '06->
164 011	Fiat	Soporte cristal elevallunas delantero derecho Ducato '06->, Linea, Palio
	PSA	Soporte cristal elevallunas izquierdo Jumper, Boxer '06->
164 012	Fiat	Soporte cristal elevallunas trasero derecho Palio, Punto '00->'09
164 013	Fiat	Soporte cristal elevallunas trasero izquierdo Palio, Punto '00->'09
164 014	Renault	Base soporte derecho parabrisas Laguna I '94->'01 (Eurocode 7237ASCHBR)
164 015	Renault	Base soporte izquierdo parabrisas Laguna I '94->'01 (Eurocode 7237ASCHBL)
164 016	PSA	Fijac. moldura lateral puerta C5 '08->
164 017	VAG	Fijac. rejilla parabrisas "torpedo" Skoda Fabia '00->'07 (Eurocode 7808ASCHB)
	VAG	Fijac. insonorizante capó A3 '13, León '13, Golf VII '13, Passat '05 y '11, fijac. tapiz. maletero Octavia '04->
164 018	Rover	Fijac. moldura parabrisas Land Rover Discovery 3 y 4, Range Rover '02 y '10-> (Eurocode 7032ASCRES2B)
164 019	Toyota	Fijac. rejilla parabrisas "torpedo" Avensis '97->'03 (Eurocode 8305ASCH)
164 020	Lexus	Fijac. rejilla parabrisas "torpedo" IS F '08->, IS 250/220 '05->, GS450H, LX470 '02->, LS460/600
	Toyota	Fijac. rejilla parabrisas "torpedo" Avensis '97->'03, Corolla '01->'06 (Eurocode 8304ASCHB)
	Toyota	Fijac. rejilla parabrisas "torpedo" Avensis '97->'03, Corolla '01->'06
164 021	Volvo	Fijac. rejilla parabrisas "torpedo" S60 '01->'09, S80 '98->'06, S90, V70 '00->'08, V90 (Eurocode 8828ASC6B)
164 022	universal	
	Volvo	Remache fijac. rejilla parabrisas "torpedo" S60 '11->, S80 '07->, V70 '08->, XC60, XC70, XC90 '03 (Eurocode 8836ASC6B)
164 023	VAG	Fijac. moldura lateral Audi Q7
164 024	universal	
	Toyota	Fijac. moldura pasoruada Auris, Avensis '03->'08 y '08->, Aygo, Corolla '06, Corolla Verso, Yaris '99, Rav4 '05, fij. bajos carrocería Auris, Avensis '03, Corolla '01, Prius '09, Rav4 '05
164 025	Opel	Fijac. moldura inferior parabrisas Astra J '10-> (Eurocode 6324ASCHBS)
164 026	BMW	Fijac. varios usos - varios modelos -
	Ford	Fijac. varios usos - varios modelos -
	VAG	Fijac. marco ventanilla y retrovisor Seat Altea, Leon '13, Mii, Toledo '05, Skoda Citigo, Rapid, VW Passat CC '09, Polo '02->, Up



INDICE REFERENCIAS

FAM. 0300	Marca	Descripción
164 027	Mercedes	Fijac. panel puerta y tapizados interiores Clase C (W203), Clase E (W211), GL, ML (W164)
	Smart	Fijac. panel puerta Smart ForTwo
	VAG	Fijac. moldura placa matricula VW Crafter '06->
164 028	VAG	Fijac. junta goma puerta Seat Exeo
164 029	VAG	Fijac. panel puerta Skoda Felicia, Pick Up, VW Caddy '96->'01
164 030	VAG	Fijac. moldura parabrisas Skoda Yeti '10-> (Eurocode 7813ASCSS6B)
164 031	VAG	Fijac. moldura parabrisas Skoda Yeti '10-> (Eurocode 7813ASCSS)
164 032	BMW	Fij. moldura lateral parabrisas serie 7 '02->'08 (E65 / E66 / E67) (Eurocode 2443ASCSS6B)
164 033	BMW	Fij. moldura lateral parabrisas serie 7 '02->'08 (E65 / E66 / E67) (Eurocode 2443ASCSS1B)
164 034	BMW	Fijac. moldura talonera puerta X3 '10->, (F25), X5 '07-> (E70) y '13-> (F15), X6 (E71)
	Mini	Fijac. moldura talonera puerta Countryman (R60) y Paceman (R61)
164 035	BMW	Fijac. torpedo parabrisas serie 3 (E46), serie 7 (E65/66/67), s.5 (F07), X3 '03 (E83), Z4 (Eurocode 2443ASCSSB)
	Rover	Fijación rejilla parabrisas "torpedo" Range Rover '10->
164 036	BMW	Fijac. moldura talonera puerta y aleta trasera X3 '10-> (F25), X5 '07-> (E70) y '13-> (F15), X6
	Mini	Fijac. moldura lateral parabrisas R60 Countryman, R61 Paceman
	Mini	Fijac. moldura talonera puerta Countryman (R60) y Paceman (R61)
164 037	VAG	Fijac. junta goma puerta Skoda Octavia '04->, VW Scirocco '08->
164 038	BMW	Fijac. panel puerta X5 '07->'13 (E70/E71), X6 y Z4
	Mini	Fijac. panel puerta Countryman (R60) y Paceman (R61)
164 039	BMW	Fijac. panel puerta serie 3 (E90/91/92/93), serie 5 (E60/61), serie 6 (E63/64), Z4
	Mini	Fijac. moldura lateral parabrisas R55, R56, R57, R58, R59 y F56 '14->
164 040	BMW	Fijac. moldura talonera puerta serie 5 (E60/61), serie 6 (E63/64) (monta con 164.041)
164 041	BMW	Fijac. moldura talonera puerta serie 5 (E60/61), serie 6 (E63/64) (monta con 164.040)
164 042	BMW	Fijac. panel puerta serie 3 (E46/E90/91/92/93), X5 '00->'07 (E53)
164 043	universal	
	Chevrolet	Fijac. parachoque y otros usos Aveo, Cruze, Equinox, Volt
	Ford	Remache fijac. parachoque y parrilla radiador C-Max '11->, Focus '11, fijac. deflector parachoque Fiesta '08->, y fijac. pasoruada Galaxy '06->, Mondeo '07->, S-Max '06->
	Opel	Fijac. parachoques y rejilla calandra Astra J, Zafira C '12->
164 044	Ford	Fijac. moldura inferior puerta Focus '11->
164 045	Ford	Fijac. moldura inferior puerta C-Max '11->
164 046	Chevrolet	Fijac. panel puerta Equinox, Volt
	Opel	Fijac. panel puerta Astra J, Insignia, Meriva B '10->, Zafira C '12->
164 047	Chevrolet	Fijac. panel puerta Cruze, Equinox
	Opel	Fijac. panel puerta Astra J, Insignia, Meriva B '10->, Zafira C '12->
164 048	Volvo	Fijac. talonera puerta S80 '07->, XC90 '03->
164 049	Volvo	Fijac. aletas V70 '01->'07, XC70 '08->, XC90 '03->, fijac. parachoque trasero V70 y XC60
164 050	Volvo	Fijac. moldura parabrisas Volvo 960 '91->'07, S90 '97->'98 (Eurocode 8812ASCS)
164 051	universal	
	BMW	Fijac. compartimiento motor serie 5 (E39) y fij. tapizados maletero s.3 (F30), s.4 (F32), s.5 (F11)
	Ford	Remache fijac. varios usos C-Max '11, Focus '04-> y '11->, Galaxy '06->, Mondeo '07->, S-Max '06



INDICE REFERENCIAS

FAM. 0300	Marca	Descripción
164 052	universal	
	BMW	Remache guía de aire serie 3 (E46), serie 5 (E39)
164 055	universal	
	Ford	Remache fijac. pasoruada Fiesta '08->
	Mazda	Fijac. parachoque y pasoruada Mazda 2, 3 y 6, fij. rejilla parabrisas "torpedo" Mazda 2 '07-> y 3,
164 056	universal	
	Ford	Remache fijac. pasoruada C-Max '11->, Focus '11->
164 057	BMW	Fijac. tapizados interiores serie 5 (F10/11), serie 6, serie 7 (E65/66/67/F01/02/03/04), i3 '13->
164 058	Volvo	Fijac. insonorizante motor S40, S60, S80, V50, V60, V70, XC60, XC70, XC90
164 059	universal	
	Fiat	Fij. tapizados maletero Fiat 500, Ducato, Grande Punto '05->, Panda '03 y '12->, Punto EVO '09->
	Ford	Fijac. tapizados interiores Ka '08->
	PSA	Fijac. tapizados interiores Jumper, Boxer '02->'06 y '06->
164 060	universal	
	Opel	Fijac. tapizados interiores Astra H, Meriva A '03->'10, Vectra C
164 061	universal	
	Ford	Taco fijac. parachoque Transit '06->, fij. tapizados interiores Fiesta '02->'08, Focus '04->'11, Fusion
164 062	universal	
	Ford	Taco fijac. panel puerta Fiesta '08->
164 063	universal	
	Rover	Fijación rejilla parabrisas "torpedo" Range Rover '02->'09 Y '10->
164 064	Volvo	Fijac. panel puerta S80 '03->'06, XC90 '03->
164 065	universal	
	BMW	Fijac. talonera puerta, tapizados interiores y otros usos -varios modelos-
164 066	Rover	Fijación panel puerta Discovery 1 y 2 '94->'04, Freelander '96->'06 y Range Rover '95->'02
164 067	Rover	Fijación panel puerta Freelander '07->
164 068	Ford	Fijac. moldura inferior puerta C-Max '03->'10, Focus '04->'11
164 069	VAG	Fijac. moldura puerta VW Touareg '11->
164 070	VAG	Tapón fijac. parachoques Audi A1, A3, Q5, Q7, VW Golf V, Passat '05->, Polo '02, Tiguan, Touran, Transporter
164 071	VAG	Fijac. moldura talonera puerta Audi A6 '11-> (forma parte del KIT: 4G0898909)
164 072	universal	
	BMW	Fijac. tapizados interiores serie 1 (E87/88/F20/21), serie 3 (E46/E90/91/92/93/F30/31), X1, X3 y X5
164 073	universal	
	Ford	Fijac. elevelunas Fiesta '08->
164 074	Rover	Fijación parachoques Discovery 3 '05->, Range Rover '02->'09
164 075	Rover	Fijación parachoques Discovery 3 '05->, Range Rover '02->'09
164 076	Ford	Fijac. panel puerta Focus '11->, Ranger '11->
164 077	VAG	Fijac. junta capó Seat Leon '13->
	VAG	Fijac. junta goma puerta Seat Ibiza '08->
164 078	universal	
	Fiat	Fijac. parachoques Fiat Panda '03, Punto '03



INDICE REFERENCIAS

FAM. 0300	Marca	Descripción
164 079	universal	
	Fiat	Taco fijac. tapizados interiores Fiat Dobló, Palio, Stilo,
164 080	Renault	Fijac. moldura lateral parabrisas Modus (Eurocode 7263ASCVS)
164 081	Mercedes	Fijac. moldura techo Mercedes Vito (W639)
	VAG	Fijac. moldura ventanilla puerta Audi Q5, VW Touareg '03->'10
164 082	VAG	Fijac. moldura puerta VW Touareg '03->'10
164 083	VAG	Tapón protector motor/cárter Audi A4 '94->'08, A6 '95->'05, VW Passa '00->'05
164 084	universal	
	Nissan	Fijac. rejilla parabrisas "torpedo" y otros varios usos Almera, Cabstar, Micra, Note, Patrol, Primera, Qashqai, Teana, Tiida, Vanette
164 085	universal	
	Mitsubishi	Fijac. parachoque Colt, Lancer, Montero/Pajero '06->, Outlander
164 086	universal	
	Mazda	Fijac. parachoque trasero Mazda 3, 323 y MPV '02->, fij. parachoque delantero Mazda CX-9, MX-5
164 087	universal	
	Lexus	Fijac. rejilla calandra LFA, RX300, fijac. parachoque RX350/450
	Toyota	Fijac. parachoque Verso '09->, Camry '06->
164 088	PSA	Sujec. cristal C4, C4 Picasso, P-307 restyling, P-308, P-407
164 089	PSA	Fijac. tapizados interiores Berlingo '09->, C2, C3, C4, C4 Picasso, P-206, P-207, P-307, P-308, P-1007, Partner '09->
164 090	PSA	Fijac. rejilla radiador Boxer / Jumper III '06->
164 091	universal	
	Lexus	Fijac. varios usos IS220D/250, IS F, RX300
	Toyota	Fijac. parachoques Prius '03->'09, fij. pasoruada Corolla '01->'06, Hi-Ace, Rav4 '00->'05, y otros usos Avensis ->'09
164 092	universal	
	PSA	Fijac. pasoruada Berlingo '02->'08, Saxo, Xsara II, Xsara Picasso, Partner '02->'08, fijac. tapizados interiores C5, Xsara, P-508
164 093	Opel	Fijac. moldura parabrisas Zafira C '12-> (Eurocode 6332ASCMS)
164 094	Ford	Fijac. panel puerta C-Max '11->
164 095	universal	
	Ford	Fijac. tapizados interiores Focus '04->'11, Kuga
164 096	Renault	Fijac. molduras laterales puerta Clio 4 '12->
164 097	universal	
	BMW	Remache fijac. tapizados interiores serie 3 (E46)
	VAG	Remache fijac. bajos carrocería Audi A5, fijac. tapizados interiores A5, A6, A7, Skoda Fabia '07->
164 098	VAG	Fijac. cierre capó Audi A3 '13->, A6 '12->, A7, A8
164 099	universal	
	Lexus	Fijac. bajos carrocería IS F '07->, LS460, LS600H, LX570
	Toyota	Fijac. bajos carrocería Auris '07->, Avensis '08->, Corolla '06->, Prius '09->, Land Cruiser '07->
164 100	universal	
164 101	universal	
	Nissan	Fijac. varios usos Patrol, Pathfinder, Terrano
	Renault	Taco fijac. pilotos traseros Clio III, Kangoo '08->, Megane II y III



INDICE REFERENCIAS

FAM. 0300	Marca	Descripción
164 102	PSA	Fijac. varios usos P-207, P-3008, P-5008
	Renault	Fijac. varios usos Megane III Coupé, Scenic III
164 103	Renault	Fijac. airbag Latitude, Scenic III, fijac. pantallas térmicas escape Kangoo '08->
164 104	Renault	Fijac. rejilla calandra Vel Satis, y otros usos Espace IV, Laguna III
164 105	Renault	Fijac. varios usos Laguna III
164 106	Renault	Fijac. junta goma puerta Clio III
164 107	universal	
	Mercedes	Remache fijac. pasoruada y aleta delantera Vito (W639)
164 108	Mercedes	Fijac. insonorizante capó Clase C (W204), Clase E (W212), Vito (W639)
164 109	universal	
	Mercedes	Fijac. tapizados interiores Sprinter
164 110	universal	
	Mercedes	Remache fijac. aletas Clase E (W211) '02->'08
164 111	Mercedes	Fijac. moldura talonera puerta Clase E (W211) '02->'08
164 112	Mercedes	Fijac. altavoces Sprinter, Vito
	universal	
164 113	Mercedes	Fij. moldura aleta Clase C (W203), fij. otros usos Clase A (W169), Clase B (W245), Clase E (W211)
164 114	Mercedes	Fijac. moldura puerta (parte delantera) Clase C (W203)
164 115	Mercedes	Fijac. moldura puerta Clase C (W203) '00->'07, Clase E (W211) '02->'08, Vito (W639)
164 116	Mercedes	Fijac. moldura inferior puerta Clase E (W211) '02->'08, Clase S
164 117	Mercedes	Fijac. moldura pilar A Clase A (W168 y W169), fij. moldura pilar B Clase M (ML) '05->, GL '05->
	universal	
164 118	VAG	Remache fijac. parachoque Audi A1, Skoda Roomster, fij. tapiz. interiores VW Polo '13->
164 119	Mercedes	Fijac. bajos carrocería Clase E (W212) '09->
164 120	Mercedes	Taco fijac. varios usos Sprinter y Vito (W639)
164 121	Opel	Fijac. panel puerta Astra H (3 puertas)
164 122	universal	
	Mercedes	Remache fijac. tapizados maletero Clase B (W245), Clase C (W202 y 203), Clase E (W210 y 211)
164 123	Rover	Fijación moldura aleta Discovery 4 '10->
164 124	universal	
	Mercedes	Taco fijac. parachoque trasero Clase B (W245), ML '11->, y fij. tapizados interiores Clase C (W203)
	Smart	Taco fijac. parachoque trasero Smart Fortwo
164 125	Mercedes	Fijac. varilla capó Clase C (W202/W203/W204), Clase E (W210/W211/W212), GL, ML, CLK, SLK
164 126	universal	
	Mercedes	Remache fijac. moldura inferior puerta SLK, fij. radiador CL500 y Clase S, y otros usos
164 127	Mercedes	Fijac. panel puerta Clase C (W204), GL, ML (W164) '05->, fij. tapizados interiores Clase E (W212)
164 128	Mercedes	Fijac. anagrama Clase A, Clase B, Clase E (W212) '09->, GL, ML, CLK
	universal	
164 129	PSA	Fijac. moldura parabrisas C3 Pluriel, Xsara '97->'00 (Eurocode 2730ASCTS2B)
	PSA	Fijac. parachoque trasero Peugeot 307



INDICE REFERENCIAS

FAM. 0300	Marca	Descripción
164 130	PSA	Fijac. pasoruada Berlingo, C4 Picasso, Saxo, Xsara II, Xsara Picasso, P-106, P-205, Partner, fijac. parachoque C3 y tapizados interiores varios modelos
164 131	VAG	Fijac. junta goma puerta VW Transporter T5 '03->
164 132	Opel	Fijac. varilla capó Ampera, Signum, Vectra C
164 133	Opel	Fijac. varilla capó Corsa C, Meriva A '03->, Tigra '04->
164 134	universal	
	Chevrolet	Fijac. tapizados interiores y otros usos Aveo '04->, Cruze
	Opel	Taco fijac. tapizados interiores Antara '07->
164 135	Opel	Fijac. moldura talonera puerta Corsa C
164 136	BMW	Fij. moldura lateral parabrisas serie 3 '11-> (F30/31/34), serie 4 (F32/33) (Eurocode 2465ASCSS)
164 137	BMW	Fij. moldura lateral parabrisas serie 3 '12-> (F34), serie 4 (F32/33) (Eurocode 2471ASCSS)
164 138	BMW	Fij. moldura lateral parabrisas X5 '12-> (F15)
164 139	Mini	Fijac. moldura techo R55, R56
164 140	Mini	Fijac. moldura techo R56
164 141	Opel	Fijac. cierre puertas Astra F, Corsa A, B y C, Kadett, Meriva A, Vectra A y B
164 142	universal	
	BMW	Fijac. bajos carrocería serie 1, serie 3 (E90/91/92, F30/31), serie 4 (F32/33), serie 5 (F10/11), X1
164 143	VAG	Fijac. pasoruada Audi A1
164 144	VAG	Fijac. pasoruada Audi A3 '13->, y fijac. tapizados maletero Passat '09->
164 145	VAG	Fijac. panel puerta Audi A3 '13->
164 146	VAG	Fijac. tapizados puerta Seat Alhambra '11->, VW Passat '05 y '11->, Sharan '11->, Tiguan
164 147	Rover	Fijac. moldura puerta Range Rover '10->
164 148	Rover	Fijac. moldura puerta Range Rover '10->
164 149	Mercedes	Fijac. moldura puerta (parte delantera) Clase E (W212) '09->
164 150	Mercedes	Fijac. moldura puerta (parte delantera) Clase E (W212) '09->
164 151	Mercedes	Fijac. moldura puerta (parte central) Clase E (W212) '09->
164 152	Mercedes	Fijac. moldura puerta (parte trasera) Clase E (W212) '09->
164 153	universal	
	Fiat	Fijac. rejilla parabrisas "torpedo" Fiat Sedici '06->
	Fiat	Fijac. rejilla parabrisas "torpedo" Fiat Sedici '06->
	Suzuki	Fijac. parachoque Swift '05->
164 154	universal	
	Honda	Fijac. rejilla radiador Accord '03->, Civic '03->'05, FR-V '05->, fijac. pasoruada Insight '10->, fijac. parachoque Civic '06->, Jazz '05->,
164 155	universal	
	Honda	Fijac. pasoruada Accord '13->, Civic '13->
164 156	universal	
	Mazda	Fijac. pasoruada Mazda 3, 5, 6, 323 y CX-7
164 157	universal	
	Mazda	Fijac. parachoque Mazda 2, 3, 5, 6, 323, BT-50, CX-7, CX-9, fijac. parrilla radiador Mazda 2 '09->, 6, 323, BT-50, CX-5
164 158	PSA	Fijac. parachoque delantero C5 '08->, Jumpy III '07->, P-406, P-407, P-607, Expert III '07->



INDICE REFERENCIAS

FAM. 0300	Marca	Descripción
164 159	Volvo	Fijac. parachoque S40 / V40 '96->'04
164 160	PSA	Fijac. moldura inferior puerta C6, y fijac moldura lateral puerta P-607
164 161	universal	
	Ford	Remache fijac. pasoruada Fiesta '08->
164 163	Fiat	Fijac. panel puerta Fiat 500, Grande Punto '05->
164 164	PSA	Fijac. moldura puerta P-208
164 165	VAG	Fijac. junta goma puerta Audi A6 '11->, A8 '10->
164 166	VAG	Tapón fijac. parachoques Touareg '03->'10
164 167	VAG	Junta fijac. prachoque A1, A3 '08, Q5, Q7, Skoda Fabia '07, VW Golf V, Passat '05, Polo, Tiguan, Touareg '03, Touran, Transporter T5
164 168	universal	
	VAG	Fijac. tapizados interiores A1, Q7, Golf V, VI y VII, Passat '05->, Touareg '03, Touran '03 y '10->
164 169	universal	
	VAG	Fijac. junta goma puerta Skoda Fabia '00 y '07->, Octavia '00->
	VAG	Fijac. tapizados puerta Skoda Fabia, Octavia
164 170	Rover	Fijación pasoruada Discovery 4 '10->
164 171	PSA	Fijac. moldura parabrisas-techo P-206 (Eurocode 6539ASCHDS)
	PSA	Fijac. moldura techo P-206, P-307, otros usos P-205, P-605
164 172	Volvo	Fijac. moldura lateral parabrisas XC60 '09-> (Eurocode 8840ASCRS)
164 173	Mitsubishi	Fijac. moldura parabrisas Colt '04-> (Eurocode 5670ASCH1 / 5672ASCH1)
164 174	Mitsubishi	Fijac. moldura parabrisas Colt '04-> (Eurocode 5676ASCH1 / 5676ASCHDS1B)
164 175	Honda	Fijac. moldura aleta trasera Civic '06->, CR-V '07->, fijac. talonera puerta Accord '08->
164 176	Honda	Fijac. moldura puerta CR-V '02 y '07->
164 177	universal	
	Honda	Fijac. pasoruada y bajos carroceria Accord '08->, Jazz '08->, fij. bajos carroceria Civic '06->
164 178	universal	
	Honda	Fijac. talonera puerta y bajos carroceria Civic '06->, fij. bajos carroceria Accord '08->, CR-V '07->, fijac. aletas Insight '10->, fijac. parachoque delantero Jazz '12->
164 179	universal	
	Hyundai	Fijac. parachoque Santa fe, Tucson '04->'09
164 181	Honda	Fijac. moldura puerta Civic '06->, Jazz '02->'08
164 182	Honda	Fijac. moldura puerta Civic '06->, fijac. moldura inferior puerta CR-V '02 y '07->
164 183	Mazda	Fijac. panel puerta Mazda 2, 323, 626, 929, MX-3, RX-7
164 186	Toyota	Fijac. parachoques Camry '05, Verso '10->, fijac. pasoruada Auris '07->, Corolla '06->, Prius '09->
164 187	universal	
	Toyota	Fijac. parrilla radiador Avensis '03->'08
	Lexus	Fijac. parachoque IS250/220D '05, GS450H, LS430, LX570
164 188	Toyota	Fijac. parachoques Auris '07, Avensis '08, Camry, Corolla '06, Land Cruiser '02 y '09, Verso '10, fijac. pasoruada Prius '09->
164 189	universal	
	Lexus	Fijac. parachoque IS F '07->, IS250/220D '05->
	Toyota	Fijac. talonera puerta Land Cruiser '02-'09, fij. tapizados interiores Camry, Celica, Corolla



INDICE REFERENCIAS

FAM. 0300	Marca	Descripción
164 190	universal	
	Honda	Fijac. moldura lateral parabrisas (parte superior) CR-V '07-> (Eurocode 4000ASCRS3B)
164 191	Honda	Fijac. moldura lateral parabrisas (parte inferior) CR-V '07-> (Eurocode 4000ASCRS)
164 192	Rover	Fijación rejilla parabrisas "torpedo" y talonera puerta Range Rover, otros usos Discovery 1 (Eurocode 7033ASSRS)
164 193	universal	
	Rover	Fijación rejilla parabrisas "torpedo" Range Rover Evoque (Eurocode 7042ASSRS1B)
164 194	Rover	Fijac. moldura lateral parabrisas Rover 75 (Eurocode 7035ASCST)
164 195	Rover	Fijac. moldura lateral parabrisas Rover 75 (Eurocode 7035ASCSS)
164 197	Mitsubishi	Fijac. moldura puerta Lancer '00, fijac. moldura aleta Montero / Pajero '00->'06, Outlander '03->'08
164 198	Mitsubishi	Fijac. moldura puerta Outlander '03->'08
164 199	Mitsubishi	Fijac. moldura talonera puerta Grandis '04, Outlander '06, Montero / Pajero '00 y '06->, fijac. panel puerta ASX '10->
164 200	Mitsubishi	Fijac. moldura puerta Colt ->'95, Galant ->'02
164 201	Mitsubishi	Fijac. moldura parabrisas Montero / Pajero ->'06, Lancer '00-> (Eurocode 5637ASCR)
164 202	Mitsubishi	Fijac. moldura parabrisas (lado izquierdo) Montero / Pajero '00->'06 (Eurocode 5660ASCR1)
164 203	Mitsubishi	Fijac. moldura parabrisas (lado derecho) Montero / Pajero '00->'06 (Eurocode 5660ASCR2)
164 204	universal	
	Fiat	Fijac. cubierta capó Alfa Romeo Mito, Fiat Dobló '09->, Fiorino, Grande Punto '05->, Panda '12, Punto EVO '09, Qubo
164 205	Honda	Fijac. junta goma puerta CR-V '97->'06
164 206	Honda	Fijac. junta goma puerta Accord '08->, Civic '01 y '06->, CR-V '07->, HR-V, Insight '10->
	Toyota	Fijac. junta gomas puerta Auris '07->, Avensis '03->, Camry '01->, Celica, Corolla
164 207	Honda	Fijac. rejilla parabrisas "torpedo" Accord '08->, Insight '10->, Jazz '09-> (Eurocode 4003ASCSB)
164 208	Honda	Fijac. moldura portón trasero Accord '08->, CR-V '07->, Insight '10->, Odyssey '08->, fijac. moldura anagrama Jazz '09->, fij. talonera puerta Odyssey '11->
164 210	Honda	Fijac. moldura lateral parabrisas Civic '01->'05 (Eurocode 3974ASCHS)
164 211	Honda	Fijac. moldura lateral parabrisas Civic '01->'05 (Eurocode 3976ASCHS2B)
164 212	Honda	Fijac. moldura lateral parabrisas Civic '01->'05 (Eurocode 3976ASCHS3B)
164 213	Honda	Fijac. moldura lateral parabrisas Civic '01->'02 (5 puertas) (Eurocode 3974ASCHS4B)
164 214	Honda	Fijac. moldura puerta Civic '00 y '06->, CR-V '00->'06, MR-V
164 215	Honda	Fijac. moldura puerta Civic '90->'00, CR-V '97->'01, Legend '96->'04
164 216	Honda	Fijac. moldura aleta delantera CR-V '97->'06, fij. moldura puerta Civic '95->'00 (3 puertas)
164 217	Honda	Fijac. moldura aleta delantera CR-V '97->'06
164 219	Honda	Fijac. pasoruada Accord '03 y '08->
164 221	Subaru	Fijac. moldura puerta Legacy '00->, Outback '00->
164 222	Mitsubishi	Fijac. moldura puerta Montero / Pajero '00->'06
164 223	Honda	Fijac. rejilla parabrisas "torpedo" Accord '03->, Civic '00 y '06->, CR-V '01->'06, FR-V '05, Odyssey (Eurocode 3999ASCSB)
164 224	Honda	Fijac. rejilla parabrisas "torpedo" Civic '06->, CR-V '05->'06, Legend '07->, Odyssey '06->'10
164 225	Honda	Fijac. insonorizante capó Accord '99->'08, HR-V '99->'05, Insight '01->'05
164 226	Honda	Fijac. aletas Accord '09->'13, Civic '06->'11, fijac. rejilla parabrisas "torpedo" CR-V '07-> (Eurocode 4000ASCRB)
164 227	Nissan	Fijac. tapizados interiores Micra '03->'10, Primera '00



INDICE REFERENCIAS

FAM. 0300	Marca	Descripción
164 228	universal	
	Nissan	Fijac. rejilla parabrisas "torpedo" Patrol '98->'06
164 229	Nissan	Fijac. juntas goma puerta Murano '05->, Patrol '98->'06
164 230	universal	
	Nissan	Fijac. pasorueda Juke, Micra '10->
	Renault	Remache fijac. varios usos
164 231	Nissan	Fijac. parrilla radiador Almera '95->'00, Micra ->'02, Murano, NV200, Patrol, Pathfinder, Qashqai, Terrano II
164 232	Nissan	Fijac. rejilla parabrisas "torpedo" Terrano 2
164 233	Mazda	Fijac. parachoque Mazda 2, 3, 5, 6, 323, CX-5, CX-7, CX-9, 323 y 626
164 234	Mazda	Fijac. talonera puerta Mazda 2, 3, 5, 6, CX-7 y CX-9
164 235	Mazda	Fijac. talonera puerta Mazda 2, 3, 5, 6, CX-7 y CX-9
164 236	universal	
	Mazda	Fijac. tapizados interiores Mazda 3, 5, 6, 323, CX-9
164 237	Mitsubishi	Fijac. moldura talonera puerta Galant 96->'03, Montero / Pajero '00->'06, Space Wagon '98->'04
164 238	Mitsubishi	Fijac. parachoques Colt, Galant ->'03, Lancer, Outlander '03->'08, Space Runner ->'99
164 239	Mitsubishi	Fijac. insonorizante motor ASX '10->, Grandis '04->, L200 '05->, Lancer, Montero / Pajero '06->, Outlander '03 y '08
164 240	Mitsubishi	Fijac. rejilla parabrisas "torpedo" Montero / Pajero '00->'06 (Eurocode 5660ASCR)
164 241	Toyota	Fijac. parachoque Corolla '01->'06, Hi-Ace, Hi-Lux, Land Cruiser '07->, Prius '09->, Rav 4 '05->'12
164 242	Subaru	Fijac. tapizados interiores Subaru
	Toyota	Fijac. panel puerta Auris '07->, Camry '01 y '06->, Corolla '06->
164 243	Toyota	Fijac. talonera puerta Auris '07->, Corolla '01->'06, Prius '03->, Yaris '05->
164 244	Toyota	Fijac. moldura aleta derecha Land Cruiser '02->'09
164 245	Toyota	Fijac. moldura aleta izquierda Land Cruiser '02->'09
164 246	VAG	Fijac. panel puerta Caddy '04, Golf V, Passat '05, Polo '02, Scirocco, Touran '03
164 247	VAG	Fijac. panel puerta Caddy '04 y '11, Golf V y VI, Passat '05->'07, Polo '02, Scirocco, Touran '03, Transporter '09->
164 248	Volvo	Fijac. juntas puerta 850, 960, S60 '01->'09, S70 '97->'00, S80 '99->'06, S90, V70 '97->'08
164 249	Chrysler	Fijac. panel puerta Chrysler Voyager '01->'03, Grand Voyager '96->'07, Dodge Caravan '96->'07, Nitro '10, Jeep Grand Cherokee '99->'01
164 250	Chrysler	Fijac. panel puerta Jeep Grand Cherokee '93->'05, fij. tapizados maletero Dodge Journey '13->
164 251	Chrysler	Fijac. panel puerta Chrysler Voyager '01->'03, Grand Voyager '96->'07, Dodge Caravan '96->'07, Nitro '10, Jeep Grand Cherokee '10
164 252	PSA	Fijac. parachoque trasero C5 '08->
164 253	universal	
	BMW	Remache fijac. parachoque serie 3 (E46)
164 254	universal	
	Nissan	Fijac. parachoques y parrilla radiador Qashqai, fijac. parachoques Micra '03->, Note '06->
	Renault	Remache fijac. rejilla parabrisas "torpedo" Clio IV '12->, Megane III '08->, Scenic III, Master '10->
	Renault	Remache fijac. rejilla parabrisas "torpedo" Clio IV '12->, Megane III '08->, Scenic III, Master '10->
164 255	universal	
	BMW	Remache fijac. talonera puerta serie 5 (F07/10/11), s.6 (F12/13), s.7 (E38/E65/F01/02/03/04)
	Mini	Fijac. tapizados maletero R52



INDICE REFERENCIAS

FAM. 0300	Marca	Descripción
164 256	universal	
	Opel	Fijac. rejilla parabrisas "torpedo" y tapizados interiores Insignia, Meriva B '10->
164 257	universal	
	VAG	Remache fijac. rejilla delantera, parachoque y tapiz. interiores Audi A4, A6, Seat Altea, Arosa, Exeo, Ibiza '02 y '09->, Cordoba '03, León '05, Toledo '05, Skoda Fabia '00 y '07, Rapid, Superb, Yeti, VW Caddy '04, Golf V y VI, Lupo, Polo '02 y '09->, Tiguan, Touran
164 258	universal	
	Volvo	Fijac. moldura talonera puerta C70 '06->
164 259	VAG	Fijac. rejilla radiador VW Transporter T4 '91->'03
164 260	Ford	Fijac. tapizados interiores C-Max '11->
164 261	universal	
	Mercedes	Remache fijac. revestimientos interiores Mercedes
	VAG	Remache fijac. revestimientos interiores varios modelos
164 262	Ford	Fijac. moldura retrovisor Focus '08->'11, Kuga
164 263	Ford	Fijac. tapizados interiores Focus '04->'11, Kuga, Mondeo '07->
164 264	Ford	Fijac. rejilla parabrisas "torpedo" Transit Connect '02-> (Eurocode 3743ASCV)
164 265	VAG	Fijac. panel puerta Seat León '13->
164 266	VAG	Fijac. panel puerta Seat Mii, Toledo '13->, Skoda Citigo, Rapid '13->, VW Amarok, Golf VII '12->, Passat '11->, Up
164 267	Mercedes	Fijac. moldura techo ML '05-> (W164)
164 268	VAG	Fijac. parachoque trasero Audi Q5
164 269	VAG	Fijac. moldura lateral (parte delantera) Audi A3 Coupé
164 270	VAG	Fijac. moldura lateral (parte trasera derecha) Audi A3 Coupé
164 271	VAG	Fijac. moldura lateral (parte trasera izquierda) Audi A3 Coupé
164 272	Opel	Fijac. moldura techo Meriva B '10->
164 273	Opel	Fijac. moldura techo Meriva B '10->
164 274	universal	
	Opel	Fijac. parachoque delantero Meriva B '10->, fijac. pasoruada Corsa C, fij. talonera puerta Vectra B
164 275	universal	
	Mercedes	Remache fijac. panel puerta Clase A (W168), fijac. rejilla parabrisas "torpedo" Clase C (W203)
164 276	Mercedes	Fijac. moldura techo CLK '02-> (W209)
164 277	Mercedes	Fijac. moldura techo-parabrisas CLS '05-> (W219)
164 278	Mercedes	Fijac. moldura techo-parabrisas Clase S '05-> (W221)
164 279	Mercedes	Fijac. moldura parabrisas Clase C '00->'07 (W203)
164 280	Mercedes	Fijac. moldura parabrisas Clase E '02->'08 (W211)
164 281	Mercedes	Fijac. moldura parabrisas Clase C '07-> (W204) y Clase E '09-> (W212)
164 282	Nissan	Fijac. moldura parabrisas superior Primastar '01->
	Renault	Fijac. moldura superior parabrisas Trafic II '01->
164 283	Volvo	Fijac. moldura lateral parabrisas V70 '08->, XC70 '08-> (Eurocode 8836ASCSS)
164 284	Nissan	Fijac. moldura aletas Juke, X-Trail '07->
164 285	Fiat	Fijac. moldura aletas y talonera puerta Sedici '06->
	Suzuki	Fijac. moldura aletas y talonera puerta SX4 '06->



INDICE REFERENCIAS

FAM. 0300	Marca	Descripción
164 286	universal	
	Mazda	Fijac. rejilla parabrisas "torpedo" Mazda 5
164 287	universal	
	Mazda	Fijac. rejilla parabrisas "torpedo" Mazda 5
164 288	Volvo	Fijac. moldura puerta S80 '07->, V70 '08->, XC70 '08->, XC90 '03->
164 289	Mazda	Fijac. panel puerta Mazda 3, 5, 6 y CX-7
164 290	universal	
	Toyota	Fijac. pasoruada Auris '07, Yaris '11->, fij. parachoque Camry, Corolla '06->, Prius '09->, Rav 4 '05->
164 291	Toyota	Fijac. pasoruada Avensis Verso '01->, Previa '00->'06, Rav 4 '05->
164 292	universal	
	Lexus	Fijac. pasoruada IS F '07->, fij. bajos carroceria RX300/350 '03->, RX400H '05->
	Toyota	Fijac. parachoque delantero Yaris '06->
164 293	PSA	Fijac. moldura lateral puerta C6
164 294	Fiat	Fijac. soporte rejilla parabrisas "torpedo" Ducato '06->
	Fiat	Fijac. soporte rejilla parabrisas "torpedo" Ducato '06->
	PSA	Fijac. soporte rejilla parabrisas "torpedo" Boxer, Jumper '06->
	PSA	Fijac. soporte rejilla parabrisas "torpedo" Jumper, Boxer '06->
164 295	BMW	Fijac. panel puerta X1, fij. tapizados techo serie 2 (F22)
	Mini	Fijac. pasoruada F56 '14->, fij. parachoque R55, R56
164 296	Renault	Fijac. rejilla parabrisas "torpedo" Twingo II '07->
164 297	Renault	Fijac. soporte inferior parabrisas Master II '03->'10
164 298	Toyota	Fijac. pasoruada Avensis Verso '01->'09, Celica, Corolla '97->'01, Rav 4 '94->'00 y '05->
164 299	universal	
	Lexus	Fijac. talonera puerta RX300/350 '03->, RX400H '05->, fij. bajos carroceria LS600H '07->
	Toyota	Fijac. parachoque Camry '00->'06 y '06->, fijac. faro Land Cruiser '98->'02
164 300	Nissan	Fijac. tapizados interiores Micra '03 y '10->, Navara, Note, Pathfinder, Primera, Qashqai, X-Trail
164 301	Dacia	Fijac. moldura inferior puerta Sandero 2 '13->
	Renault	Fijac. panel puerta Captur
164 302	Rover	Fijac. moldura techo Range Rover '10->
164 303	Dacia	Fijac. pasoruada Sandero 2 '13->
164 304	VAG	Fijac. bajos carroceria Audi A1, A3 '03 y '13->, A4 '08->, A5, Q3, Q5, Seat Alhambra '11->, Altea, Exeo, Ibiza '02 y '08->, Cordoba, León '05 y '13->, Mii, Toledo '05 y '13->, Skoda Citigo, Fabia '07, Octavia '09->, Rapid, Superb, Yeti, VW Golf V, VI y VII, Passat '08->, Polo '05 y '09->, Scirocco, Sharan '11->, Tiguan, Touran, Up
164 305	Toyota	Fijac. spoiler delantero Auris '07->, Avensis '03->'08, Corolla '00->'06, Corolla Verso '04->
164 306	Mitsubishi	Fijac. rejilla radiador Montero / Pajero '00->'06, Space Gear / L400
164 307	Mitsubishi	Fijac. junta capó ASX '10->, Grandis '04->, Lancer '00 y '07->, Outlander, Montero / Pajero '08->, fijac. rejilla radiador L200 '05->, Montero / Pajero '08->
164 308	Mitsubishi	Fijac. junta capó ASX '10, Colt '91->'03, Galant '06, Grandis, L200 '96->'07, Lancer '92->'00 y '07->, Montero / Pajero '00 y '06->, Outlander '03 y '08->, Space Runner, Space Wagon
164 309	Mitsubishi	Fijac. moldura techo - parabrisas Lancer '00->
164 310	Mitsubishi	Fijac. rejilla parabrisas "torpedo" ASX '10->, Lancer '00->, L200 '05->, Montero / Pajero Sport '08->, Outlander '06->
164 311	Volvo	Fijac. rejilla parabrisas "torpedo" S40 / V40 '96->'04 (Eurocode 8832ASCSB)



INDICE REFERENCIAS

FAM. 0300	Marca	Descripción
164 312	universal	
	Toyota	Fijac. bajos carroceria Auris '07->, Corolla '06->, Rav 4 '05->
164 313	universal	
	Rover	Fijación pasoruada Range Rover Evoque, Freelander '07->
164 314	universal	
	Nissan	Fijac. pasoruada Terrano 2
	Toyota	Fijac. bajos carroceria Corolla '01->'06, Rav 4 '05->
164 315	universal	
	Hyundai	Fijac. parachoque Kia Carens, Carnival, K2700, Pregio, Pride, Sorento, Sportage
	Mazda	Fijac. parachoque Mazda 323, CX-9, MPV
	Mitsubishi	Fijac. panel puerta Galant '92->'96
164 316	VAG	Soporte parachoques delantero derecho Audi A3 '03->'08
164 317	VAG	Soporte parachoques delantero izquierdo Audi A3 '03->'08
164 318	VAG	Soporte parachoques delantero derecho Audi A3 '08->'13
164 319	VAG	Soporte parachoques delantero izquierdo Audi A3 '08->'13
164 320	VAG	Soporte parachoques delantero derecho Audi A4 '05->'08
164 321	VAG	Soporte parachoques delantero izquierdo Audi A4 '05->'08
164 322	VAG	Soporte parachoques delantero derecho Audi A4 '08->'12
164 323	VAG	Soporte parachoques delantero izquierdo Audi A4 '08->'12
164 324	VAG	Soporte parachoques delantero derecho VW Golf V '04->'09, Jetta '05->'11
164 325	VAG	Soporte parachoques delantero izquierdo VW Golf V '04->'09, Jetta '05->'11
164 326	VAG	Soporte parachoques delantero derecho VW Passat '05->'10
164 327	VAG	Soporte parachoques delantero izquierdo VW Passat '05->'10
164 328	VAG	Soporte parachoques delantero derecho VW Passat '11->
164 329	VAG	Soporte parachoques delantero izquierdo VW Passat '11->
164 330	VAG	Soporte parachoques delantero derecho VW Polo '05->'09
164 331	VAG	Soporte parachoques delantero izquierdo VW Polo '05->'09
164 332	Ford	Soporte parachoque delantero derecho Focus '08->'11
164 333	Ford	Soporte parachoque delantero izquierdo Focus '08->'11
164 334	Ford	Soporte parachoque delantero derecho Focus '11->
164 335	Ford	Soporte parachoque delantero izquierdo Focus '11->
164 336	Opel	Soporte parachoques delantero derecho Corsa D '06->
164 337	Opel	Soporte parachoques delantero izquierdo Corsa D '06->
164 338	Toyota	Soporte parachoques delantero derecho Rav 4 '06->'13
164 339	Toyota	Soporte parachoques delantero izquierdo Rav 4 '06->'13
164 340	Fiat	Soporte parachoque delantero derecho Fiat Punto EVO '09->
164 341	Fiat	Soporte parachoque delantero izquierdo Fiat Punto EVO '09->
164 342	Fiat	Soporte parachoque delantero derecho Fiat Panda '12->
164 343	Fiat	Soporte parachoque delantero izquierdo Fiat Panda '12->
164 344	PSA	Soporte parachoque delantero derecho C1, P-107



INDICE REFERENCIAS

FAM. 0300	Marca	Descripción
164 345	PSA	Soporte parachoque delantero izquierdo C1, P-107
164 346	PSA	Soporte parachoque trasero derecho C1, P-107
164 347	PSA	Soporte parachoque trasero izquierdo C1, P-107
164 348	Toyota	Soporte parachoques delantero derecho Yaris '06->'11
164 349	Toyota	Soporte parachoques delantero izquierdo Yaris '06->'11
164 350	Renault	Kit (2 piezas) soporte parachoque delantero Megane III '08->
164 351	Opel	Fijac. junta puerta Astra J, Insignia, Meriva B '10->, Zafira C '12->
164 352	universal	
	Mitsubishi	Fijac. parachoques Galant '06->, Grandis '04->, Lancer '00 y '07->, Outlander '03->'08 y '08->, Montero / Pajero '06->
164 353	universal	
	Mazda	Fijac. moldura aleta Mazda CX-5, fij. tapizados interiores CX-7
164 354	Rover	Fijación moldura pasoruada y tapizados interiores Range Rover Evoque
164 355	Subaru	Fijac. rejilla parabrisas "torpedo" Forester '09->, Impreza '08->, Legacy '10->, Outback '08-> (Eurocode 7934ASCRB)
164 357	BMW	Fij. moldura lateral parabrisas X6 (E71/E72) (Eurocode 2456ASCRS)
164 358	Hyundai	Fijac. tapizados interiores Hyundai Elantra '00->'12, Equus, Santa Fe '06->, Kia Carnival '06->, Cerato, Sorento '06->, Sportage '04->
164 359	Hyundai	Fijac. panel puerta y tapizados interiores Hyundai Elantra, Equus, I30 '12->, Santa Fe, Sonata, Tucson, Kia Carnival '06->, Sportage '04->
164 360	Hyundai	Fijac. junta goma capó Hyundai Accent, Elantra, Santa Fe, Tucson, Kia Cerato, Sorento, Sportage
164 361	Dacia	Fijac. parachoque trasero Sandero 2 '13->
	Renault	Taco fijac. parachoque trasero Captur
164 362	Fiat	Soporte cristal elevallunas derecho Fiat Bravo '07->, Dobló '09->
164 363	Fiat	Soporte cristal elevallunas izquierdo Fiat Bravo '07->, Dobló 30009->
164 364	Renault	Soporte cristal elevallunas derecho Kangoo '08->
164 365	Renault	Soporte cristal elevallunas izquierdo Kangoo '08->
164 366	BMW	Kit soporte cristal elevallunas delantero X5 '00->'07
	PSA	Kit soporte cristal elevallunas delantero P-206
	Renault	Kit soporte cristal elevallunas delantero Megane II
164 368	PSA	Kit soporte cristal elevallunas delantero C3
	Renault	Kit soporte cristal elevallunas delantero Clio II, Scenic II
164 369	PSA	Kit soporte cristal elevallunas delantero Berlingo, Partner
164 370	Fiat	Fijac. moldura lateral puerta y aletas Panda '12->
164 371	universal	
	Fiat	Fijac. moldura puerta Fiat Panda '12->, fijac. tapizados interiores Fiat 500L, Panda '12->
164 372	VAG	Kit soporte cristal elevallunas VW Touran '03->'10
164 373	VAG	Kit soporte cristal elevallunas VW Transporter T5 '03->
164 374	Ford	Kit soporte cristal elevallunas delantero Fiesta '02->'08, Fusion
164 375	universal	
	Chrysler	Fijac. pasoruada y tapizados interiores Chrysler Voyager, PT Cruiser, Dodge Caliber, Caravan, Journey, Jeep Cherokee ->'01, Grand Cherokee '93->'01 y '09->'13, Compass



INDICE REFERENCIAS

FAM. 0300	Marca	Descripción
	universal	
164 376	Chrysler	Fijac. parachoque, pasoruada y tapizados interiores Chrysler Voyager, Grand Voyager '97->'03, Dodge Caravan, Journey, Jeep Compass '11->, Grand Cherokee '05->, Patriot '11, Wrangler '08
164 377	Chrysler	Fijac. panel puerta Jeep Grand Cherokee '06->'12
164 378	Seat	Tope (goma) capó Seat
164 379	VAG	Tope (goma) capó Seat Alhambra '97, Arosa '97, VW Golf III y IV, Lupo '99, Polo '95, Sharan '96
164 381	Fiat	Tope (goma) capó y portón Uno, Y-10
	PSA	Tope goma capó y portón AX, P-106, P-205, P-306
	Renault	Tope (goma) capó y portón Clio, Twingo, Master, Traffic
164 382	Fiat	Tope (goma) portón Bravo/a
164 383	VAG	Tope (goma) capó Seat Alhambra '97->'00, Arosa, VW Golf III, Passat '97->'00, Polo '95, Sharan '96
164 384	VAG	Tope (plástico/goma) portón Seat Ibiza/Cordoba '97->'02, VW Passat '97->'00, Polo '95->'02
164 385	PSA	Tope goma capó Berlingo, C2, C5, Xsara Picasso, P-106, P-206, P-306, P-406, Partner
164 386	Renault	Tope (goma) capó Megane II
164 387	PSA	Tope goma capó Berlingo '09->, C4 '04->'10, P-307, Partner '09->, Partner Tepee
164 388	PSA	Tope goma capó (parte delantera del capó) C4 '10->, P-308, P-3008, P-5008, RCZ
164 389	PSA	Tope goma capó (parte central del capó) C4 '10->, P-308, P-3008, P-5008, RCZ
164 390	PSA	Tope goma capó DS3, C5 '04->, C6, P-206+, P-407
164 391	Dacia	Fijac. tope cala luneta trasera Duster, Logan, Sandero
	Renault	Fijac. cala parabrisas y luneta trasera Captur, Clio IV, Megane III, Scenic I, II y III, Twingo II '07->
164 392	PSA	Fijac. tope cala parabrisas Berlingo '08, C2, C3, C3 Picasso, C5, Jumpy III, Xsara, P-407, P-1007, Expert III, Partner '08 (Eurocode 6544ASCS)
164 393	Renault	Fijac. tope cala parabrisas Clio III '05->'12
164 394	Honda	Fijac. junta goma capó Accord '94->'02, Civic '95->'00, CR-V '07->, Insight, Odyssey
164 395	Mitsubishi	Fijac. panel puerta L200 '05->, fijac. rejilla radiador Montero / Pajero '06->, fijac. tapizados interiores Colt '05->, Galant '06->, L200 '05
	Toyota	Fijac. panel puerta Aygo '05->'13, fijac. tapizados interiores Camry '06, Corolla '01 y '06->
164 396	universal	
	Toyota	Fijac. parachoque Auris '07->, Corolla '06->
164 397	Toyota	Fijac. pasoruada Aygo, Prius '03, Rav 4 '00->'05 y '05->, fijac. parachoque trasero Rav 4 '05->
164 398	Renault	Soporte cristal elevalunas trasero derecho Clio III '05->'12
164 399	Renault	Soporte cristal elevalunas trasero izquierdo Clio III '05->'12
164 400	PSA	Soporte cristal elevalunas derecho Berlingo '08->, Partner '08->
164 401	PSA	Soporte cristal elevalunas izquierdo Berlingo '08->, Partner '08->
164 402	BMW	Kit soporte cristal elevalunas delantero serie 3 (E46)
164 403	Ford	Fijac. parachoque y pasoruada Galaxy '06, Mondeo '07, S-Max '06
164 404	Chrysler	Fijac. panel puerta Dodge Journey '11->, Jeep Cherokee '06->'12
	Fiat	Fijac. panel puerta Fiat Freemont
164 405	universal	
	Chrysler	Fij. pasoruada Dodge Grand Caravan '13, Journey '11, fijac. insonorizante capó Grand Cherokee '10
	Fiat	Fijac. pasoruada Fiat Freemont



INDICE REFERENCIAS

FAM. 0300	Marca	Descripción
164 406	universal	
	Chrysler	Fijac. moldura aleta y tapizados puerta Dodge Journey '11->
	Fiat	Fijac. moldura aleta y tapizados puerta Fiat Freemont
164 407	universal	
	Fiat	Fijac. tapizados interiores Alfa Giulietta, Fiat Bravo '07, Dobló, Ducato '06, Palio, Siena, Stilo
164 408	Mitsubishi	Fijac. moldura parabrisas (parte superior) Galant ->'03, Space Runner ->'02, Space Wagon '98->'04 , fijac. luneta trasera Galant, Grandis '04->, Montero / Pajero '00 y '06-> (Eurocode 5689ASCRT)
164 409	Mitsubishi	Fijac. moldura superior parabrisas Lancer '00 y '07->, L200 '05->, Montero / Pajero '08->, Outlander '03->'08 y '08->
164 410	Mercedes	Fijac. moldura techo-parabrisas Clase A (W176) '13-> (Eurocode 5381ASCHDS)
164 411	Mercedes	Fijac. moldura techo-parabrisas Clase A (W176) '13-> (Eurocode 5381ASCHDS1B)
164 412	Mercedes	Fijac. moldura techo-parabrisas Clase A (W176) '13-> (Eurocode 5381ASCHS7B)
164 413	Mercedes	Fijac. moldura techo-parabrisas Clase A (W176) '13-> (Eurocode 5381ASCHS8B)
164 414	Mazda	Fijac. insonorizante capó Mazda 2, 3, 5, 6, CX-5, CX-7 y CX-9
164 415	universal	
	Chrysler	Fijac. parrilla radiador Dodge Journey '11->
	Fiat	Fijac. parrilla radiador Fiat Freemont
164 416	universal	
	Fiat	Fijac. parachoques Alfa Romeo Giulietta, Fiat 500 '12->, Dobló '09->, Panda '12->
164 417	Toyota	Fijac. moldura parabrisas Land Cruiser Prado '09-> (Eurocode 8394ASCRS)
164 418	Lexus	Fijac. moldura lateral parabrisas GS30/35/43 '05->'11, GS450H '06->'11, LS460 '06->, LS600 '07-> (Eurocode 8362ASCSS2B)
164 419	Suzuki	Fijac. rejilla parabrisas "torpedo" Escudo, Grand Vitara, Vitara (Eurocode 8020ASCRB)
164 420	Toyota	Fijac. moldura inferior puerta Avensis '03->'08, Camry '01 y '06->, Corolla '02->'06, fijac. tapizados interiores Hi Ace '05->
164 421	Toyota	Fijac. tapizados interiores Auris '07->, Avensis '03->'08, Corolla '01->'06, Land Cruiser '02 y '07->, Prius '03->'10, Rav 4 '05->
164 422	Toyota	Fijac. talonera puerta Auris '07->, Corolla '06->
164 423	Suzuki	Fijac. moldura inferior puerta Ignis, Wagon R+, fijac. tapizados interiores Grand Vitara
164 424	Nissan	Fijac. pasoruera Almera, Almera Tino, Primera, Qashqai, Micra '10->, Murano, X-Trail
164 425	Nissan	Fijac. pasoruera Almera '00->'06, Primera '01->'07, Qashqai
164 426	Subaru	Fijac. insonorizante motor Impreza, Legacy
164 427	Subaru	Fijac. moldura puerta Forester, Impreza, Legacy
164 428	Hyundai	Fijac. rejilla parabrisas "torpedo" ix55 '06->'12, Santa Fe '06->'09, Tucson '04->'13
164 429	Nissan	Fij. rejilla parabrisas "torpedo" Almera '95->'00, Cabstar '07->'13, Patrol '98->'06, Primera '95->'02, Terrano II '93->'00, 350Z (Eurocode 6015ASCST)
164 430	PSA	Fijac. panel puerta C1 '14->, P-108
	Toyota	Fijac. panel puerta Aygo '14->
164 431	Toyota	Fijac. moldura aleta delantera IQ
164 432	Chrysler	Fijac. Insonorizante motor Chrysler PT Cruiser, Dodge Caliber, Challenger, Journey '11, Jeep Compass '08, Grand Cherokee '09->'13, Patriot
	Fiat	Fijac. Insonorizante motor Fiat Freemont '11->
164 433	Opel	Fijac. moldura superior parabrisas Vivaro '01->
164 434	Fiat	Fijac. Faro delantero Fiat Panda '03->'11



INDICE REFERENCIAS

FAM. 0300	Marca	Descripción
164 435	Fiat	Fijac. parrilla radiador Fiat 500 '07->, Dobló, , Ducato '06->, Idea, Palio, Siena, Strada, Lancia Musa '07->
164 436	Fiat	Fijac. panel puerta Alfa Romeo 147, 156, 159, Fiat 500, Linea '07, Strada '11
164 437	Fiat	Fijac. junta goma puerta Fiat Bravo '07, fijac. junta portón trasero Fiat Ducato '11
164 438	universal	
164 438	VAG	Fijac. parachoques, pasoruada y bajos carrocería Seat Toledo '13->, Skoda Octavia '09, Rapid, Yeti, fijac. refuerzo parachoque delantero Skoda Fabia '11, Roomster '11
164 439	Mitsubishi	Fijac. rejilla parabrisas "torpedo" Colt '95->'03, fij. moldura talonera puerta Montero/Pajero '90->'04, fijac. tapizados interiores Carisma, Galant ->'03, Montero/Pajero '90->'04
164 685	Ford	Tornillo fij. intermitente delant. a parachoques Focus '98->'05 (monta con 162.963)
171 434	Fiat	Regulador eléctrico faro Fiat Scudo
173 080	Fiat	Regulador eléctrico faro Iveco Daily
	Ford	Regulador eléctrico faro Galaxy '94->'06
	Smart	Regulador eléctrico faro Smart ForTwo
	VAG	Regulador eléctrico faro A3 '03->'08, A4 '05, TT, Seat Alhambra, Skoda Octavia '00, VW Caddy '04, Golf V, LT '04->, New Beetle, Passat '09->, Polo '02->'05, Sharan, Touran, Transporter '03->
173 196	VAG	Regulador eléctrico faro Audi A2, A4 '99->'04, Q7, Seat Arosa, Ibiza/Cordoba '99->'02 y '02->'08, Leon '99->'05, Toledo '99->'04, VW Golf IV y V, Lupo, Polo '99->'05
173 197	Opel	Regulador eléctrico faro Astra H, Insignia '09, Signum, Vectra C '02->'05
	VAG	Regulador eléctrico faro Audi A3 '08, VW Crafter '06, Golf V y VI, Jetta, Passat '05, Polo '05, Touareg
175 224	Renault	Regulador eléctrico faro Clio III, Espace IV, Kangoo '08, Laguna II y III '05->, Megane II '05->, Scenic III, Trafic II
175 225	Renault	Regulador eléctrico faro Clio III, Espace IV, Laguna II '05->, Megane II '05->, Modus, Vel Satis (para faros Xenón)
176 213	Nissan	Regulador eléctrico faro Navara '05, Qashqai '06, Pathfinder '05, Primera '01
178 098	Opel	Regulador eléctrico faro Corsa D, Meriva, Signum, Tigra '04, Vectra C '05->
	VAG	Regulador eléctrico faro Audi Q5, Seat Altea, Exeo, Ibiza '09->, Leon '05, Toledo '05, Polo '05->
180 501	universal	
180 512	universal	
181 400	Seat	Guía sujeta cristal Panda (largo: 68 cm.)
181 401	Seat	Guía sujeta cristal 127 2 puertas (largo: 37 cm.)
181 403	Seat	Tirante bandeja posterior Panda, Ritmo (long.total 400 mm.)
181 404	Ford	Tirante bandeja posterior Ford Fiesta, Sierra (long.total 365 mm.)
181 405	VAG	Tirante bandeja posterior VW Golf II, Jetta (long.total 265 mm.)
181 410	VAG	Tirante bandeja posterior VW Golf (long.total 330 mm.)
181 417	Opel	Tirante bandeja posterior Opel Corsa B (long.total 285 mm.)
181 425	VAG	Leva cerradura puerta (largo: 50,1 mm.) Seat Ibiza/Cordoba '93->'99
181 426	VAG	Leva cerradura puerta (largo: 56,7 mm.) VW Golf/Vento III '92->'99, Polo Derby '95->'00
181 427	VAG	Leva cerradura puerta (largo: 71,3 mm.) Seat Ibiza/Cordoba '93->'99, Inca '96->'03
181 428	VAG	Leva cerradura puerta codificada (largo: 67,6 mm.) Seat Ibiza / Cordoba '97->'02 (5 puertas), Inca '96->'03, VW Caddy '96->'03, Polo Classic '97->'02
181 429	VAG	Leva cerradura puerta codificada (largo 47 mm.) Seat Ibiza/Cordoba '97->'02 (3 puertas)
181 431	Seat	Guía sujeta cristal Ibiza 3 puertas, Delantera (largo: 33 cm.)
181 432	Seat	Guía sujeta cristal Ibiza 5 puertas, Delantera Derecha (largo: 30 cm.)
181 433	Seat	Guía sujeta cristal Ibiza 5 puertas, Delantera Izquierda (largo: 30 cm.)



INDICE REFERENCIAS

FAM. 0300	Marca	Descripción
181 434	Seat	Guía sujeta cristal Ibiza 5 puertas, Trasera Derecha (largo: 30 cm.)
181 435	Seat	Guía sujeta cristal Ibiza 5 puertas, Trasera Izquierda (largo: 30 cm.)
181 440	VAG	Leva cerradura puerta codificada (largo 57,5 mm.) VW Polo Derby '95->'02
181 441	VAG	Leva cerradura puerta codificada (largo 42,5 mm.) Seat Alhambra, VW Sharan '96->'09
181 442	VAG	Leva cerradura puerta codificada (largo 44 mm.) VW Golf IV, Bora '99, Fox
181 591	VAG	Kit cerradura puerta codificada (largo 42,5 mm) - varios modelos -
181 592	VAG	Kit cerradura puerta codificada (largo 47,0 mm) - varios modelos -
181 593	VAG	Kit cerradura puerta codificada (largo 57,5 mm) - varios modelos -
181 594	VAG	Kit cerradura puerta codificada (largo 67,6 mm) - varios modelos -
181 595	VAG	Kit cerradura puerta codificada (largo 44,0 mm) VW Golf IV, Bora '99, Fox
181 596	BMW	Kit leva cerradura puerta derecha Serie 3 (E46)
181 597	BMW	Kit leva cerradura puerta izquierda Serie 3 (E46)
181 598	BMW	Kit leva cerradura puerta derecha X5 '00->'07
181 599	BMW	Kit leva cerradura puerta izquierda X5 '00->'07
182 308	PSA	Tirante bandeja posterior P-106 (long.total 340 mm.)
182 310	Renault	Tirante bandeja posterior Clio (long.total 240 mm.)
182 314	Renault	Tirante bandeja posterior R-19, Megane (long.total 260 mm.)
184 867	Fiat	Tirante bandeja posterior Fiat Uno (long.total 345 mm.)
184 870	Seat	Soporte parachoques delantero Panda - Izquierdo
184 871	Seat	Soporte parachoques trasero Panda - Derecho
184 872	Seat	Soporte parachoques trasero Panda - Izquierdo
184 873	Seat	Soporte parachoques delantero Panda moderno - ambos lados -
184 874	Seat	Soporte parachoques trasero Panda moderno - ambos lados -
190 001	Fiat	Surtidor lavaparabrisas Alfa Romeo 33
190 002	Fiat	Surtidor lavaparabrisas Fiat Uno ->'90
190 003	Fiat	Surtidor lavaparabrisas Fiat Uno '90.>
190 004	Fiat	Surtidor lavaparabrisas Fiat Ducato, Talento, Tipo
190 005	Fiat	Surtidor lavaparabrisas A.Romeo 145/146, 155, Fiat Tipo, Tempra
190 006	Fiat	Surtidor lavaparabrisas Fiat Punto, Lancia Y
190 007	Ford	Surtidor lavaparabrisas Fiesta '89->
190 008	Ford	Surtidor lavaparabrisas Fiesta '96->'02
190 009	Fiat	Surtidor lavaparabrisas Fiat Croma, Ducato, Lancia Thema, Y-10
190 010	Opel	Surtidor lavaparabrisas Ascona, Corsa A
190 011	Opel	Surtidor lavaparabrisas Calibra, Corsa B, Omega
190 012	Opel	Surtidor lavaparabrisas Kadett
190 013	Opel	Surtidor lavaparabrisas Astra F
190 016	Renault	Surtidor lavaparabrisas Super-5, Express
190 017	Renault	Surtidor lavaparabrisas Clio
190 018	Renault	Surtidor lavaparabrisas R-19
190 019	Renault	Surtidor lavaparabrisas R-21, Megane



INDICE REFERENCIAS

FAM. 0300	Marca	Descripción
190 020	Renault	Surtidor lavaparabrisas Twingo
190 021	Seat	Surtidor lavaparabrisas Seat 127
190 022	Seat	Surtidor lavaparabrisas Seat Panda
190 025	PSA	Surtidor lavaparabrisas Saxo, P-106, P-205, P-306, P-309
190 026	PSA	Surtidor lavaparabrisas Berlingo, Xantia, ZX, Partner
190 027	Fiat	Surtidor lavaparabrisas Fiat Bravo/a, Marea
190 028	Fiat	Surtidor lavaparabrisas Fiat Cinquecento, Seicento
190 029	Fiat	Surtidor lavaparabrisas Fiat Punto '99->, Dobló, Ducato '02, Panda '03
190 030	Renault	Surtidor lavaparabrisas Laguna
190 031	VAG	Surtidor lavaparabrisas Seat Ibiza / Córdoba '93->'99, Inca, León '99-'05, Toledo '99-'04, VW Caddy '96->'04, Golf 3/Vento, Passat ->'97, Polo (6N) '94-'02, Transporter '98->
190 032	Renault	Surtidor lavaparabrisas Clio II '98
190 034	PSA	Surtidor lavaparabrisas Xsara Picasso
190 035	PSA	Surtidor lavaparabrisas P-406, P-605
190 036	Renault	Surtidor lavaparabrisas Kangoo
190 037	Fiat	Surtidor lavaparabrisas Alfa Romeo 147
190 038	Fiat	Surtidor lavaparabrisas Fiat Punto '03->
190 039	Fiat	Surtidor lavaparabrisas Alfa Romeo 147 '00->
190 040	Fiat	Surtidor luneta trasera Alfa Romeo 147 '00->
190 041	PSA	Surtidor lavaparabrisas C1, P-107
	Toyota	Surtidor lavaparabrisas Aygo
190 042	PSA	Surtidor lavaparabrisas C4, P-308
190 043	PSA	Surtidor luneta trasera Saxo
190 044	PSA	Surtidor lavaparabrisas Xsara I y II
190 045	PSA	Surtidor luneta trasera Xsara Picasso
190 046	Fiat	Surtidor luneta trasera Cinquecento, Seicento
190 047	Fiat	Surtidor lavaparabrisas Dobló'00->, Ducato, Nuova Punto, Panda '03->
190 048	Fiat	Surtidor lavaparabrisas Multipla
190 049	Fiat	Surtidor lavaparabrisas Iveco Daily, Fiat Idea, Lancia Ypsilon
190 050	Fiat	Surtidor luneta trasera Idea, Panda '03->
190 051	Fiat	Surtidor lavaparabrisas Nuova Punto '03->
190 052	Fiat	Surtidor lavaparabrisas Fiat Punto 99->'03, Croma '05
190 053	Fiat	Surtidor lavaparabrisas Stilo (negro)
190 054	Fiat	Surtidor lavaparabrisas Stilo (gris)
190 057	PSA	Surtidor luneta trasera P-106, P-306
190 058	Renault	Surtidor luneta trasera Kangoo
190 059	Renault	Surtidor luneta trasera Laguna I, Megane I (14/10/98->)
190 060	Renault	Surtidor luneta trasera Laguna I, Megane I (->13/10/98)
190 061	Renault	Surtidor luneta trasera Laguna I, Megane Break
190 062	Renault	Surtidor lavaparabrisas Megane II



INDICE REFERENCIAS

FAM. 0300	Marca	Descripción
190 063	Renault	Surtidor luneta trasera Megane II
190 064	Dacia	Surtidor luneta trasera Duster, Sandero '08->'12
	Renault	Surtidor luneta trasera Scenic I
190 065	Mini	Surtidor lavaparabrisas R50, R52 y R53
190 066	Mini	Surtidor lavaparabrisas calentable R50, R52 y R53
190 067	Mini	Surtidor delantero derecho lavaparabrisas calentable R55, R56, R57 y R60
190 068	Mini	Surtidor delantero izquierdo lavaparabrisas calentable R55, R56, R57 y R60
190 069	Ford	Surtidor lavaparabrisas Fiesta '02->'08, Fusion
190 070	Ford	Surtidor lavaparabrisas Focus '05->
190 071	Ford	Surtidor lavaparabrisas Ka '99->'08, Street Ka
190 072	PSA	Surtidor lavaparabrisas C8, P-807
190 073	PSA	Surtidor lavaparabrisas C4 Picasso
190 074	PSA	Surtidor lavaparabrisas Berlingo '08->, DS5, Partner '08->
190 075	PSA	Surtidor lavaparabrisas C4 '10->, DS4,
190 076	PSA	Surtidor lavaparabrisas P-308
190 077	PSA	Surtidor lavaparabrisas C3 '09->, DS3
190 078	Renault	Surtidor luneta trasera Clio II '98
190 079	Renault	Surtidor lavaparabrisas Scenic II
190 080	Dacia	Surtidor luneta trasera Logan
190 351	Fiat	Bomba lavaparabrisas Alfa Romeo 145, 146, 147, 156, Fiat Bravo/a, Dobó, Idea, Punto, Stilo, Lancia Delta, Dedra, Musa, Ypsilon
190 352	Mercedes	Bomba lavaparabrisas Mercedes 190, clase C, Sprinter, Vito (W368)
	VAG	Bomba lavaparabr. Audi 80, 90, 100, VW Caddy, Golf, Polo, Passat, Transporter
190 353	Mercedes	Bomba lavaparabrisas Mercedes clase A (W168), clase E (W210)
	VAG	Bomba lavaparabrisas Audi A3, A4 '98, A6, Seat Alhambra '00->'06, Arosa, Ibiza/Cordoba '99->'02, Inca, Fabia, Octavia, VW Bora, Golf 4, Polo '95->'02, Passat '97->'00
190 354	VAG	Bomba lavaparabrisas Audi 80, 90, 100, A4, A6, A8, Cabrio, S6 quattro
190 355	Mercedes	Bomba lavaparabr. Mercedes W163, W202, W203, W210, W211, CLK, SLK
	Smart	Bomba lavaparabrisas Smart Fortwo
190 357	VAG	Bomba lavaparabrisas Audi A2, A3 '09, A4 '01, A5, A6, A8, TT, Seat Ibiza/Cordoba, Inca, León '99, Toledo '99, Skoda Fabia '07, Octavia, Superb, VW Caddy, EOS, Golf V, New Beetle, Passat, Polo ->'02, Transporter
	PSA	Bomba lavaparabrisas AX, BX, C-15, P-106, P-205, P-305, P-309, P-405
190 358	Fiat	Bomba lavaparabrisas Scudo
	PSA	Bomba lavaparabrisas AX, Berlingo, Jumpy ->'06, Xantia, XM, ZX, P-106, P-206, P-306, P-406, P-605, Expert, Partner
190 359	Ford	Bomba lavaparabrisas C-Max ->'11, Fiesta '08->, Focus '05->, Galaxy '06->, S-Max '06->, Kuga, Mondeo '00 y '07->
	Volvo	Bomba lavaparabrisas C30, C70, S40 '05->, V50 '05->
190 360	Fiat	Bomba lavaparabrisas Ulysse
	PSA	Bomba lavaparabrisas AX, Berlingo, Evasion, Saxo, Xantia, Xsara, ZX, P-106, P-206, P-306, P-406, P-806, Partner
190 361	PSA	Bomba lavaparabrisas Berlingo, C2, C3, C3 Picasso, C4, C5, C8, DS3, Jumpy III, Saxo, Xsara II, Xsara Picasso, P-106 restyling, P-207, P-307, P-308, P-807, P-1007, Partner, Expert III
	Renault	Bomba lavaparabrisas Clio III, Espace IV, Laguna II, Megane II, Modus, Scenic II, Traffic II, Vel Satis
190 362	Renault	Bomba lavaparabrisas Clio II, Kangoo, Master, Megane I



INDICE REFERENCIAS

FAM. 0300	Marca	Descripción
190 363	Honda	Bomba lavaparabrisas Accord y Civic
	Hyundai	Bomba lavaparabrisas -varios modelos-
	Mazda	Bomba lavaparabrisas -varios modelos-
	Mitsubishi	Bomba lavaparabrisas - varios modelos -
	Subaru	Bomba lavaparabrisas - varios modelos -
	Suzuki	Bomba lavaparabrisas - varios modelos -
	Toyota	Bomba lavaparabrisas - varios modelos -
190 364	Fiat	Bomba lavaparabrisas Fiat Multipla, Palio, Punto, Tipo, Delta, Dedra, Musa, Ypsilon
	Opel	Bomba lavaparabrisas Astra F, Corsa A y B, Kadett, Omega B, Vectra A
190 365	Chevrolet	Bomba lavaparabrisas Lanos, Tico
	Ford	Bomba lavaparabrisas Fiesta '76 / '89, Granada, Sierra, Transit '85->'94
	Honda	Bomba lavaparabrisas Accord ->'97
	Hyundai	Bomba lavaparabrisas Accent, Coupé, Excel, Lantra, Matiz, Nexia, Sonata '98
	Mitsubishi	Bomba lavaparabrisas Montero
	Suzuki	Bomba lavaparabrisas Swift, Vitara '97, Gran Vitara, Samurai '99
	Toyota	Bomba lavaparabrisas Land Cruiser, Prius, Rav 4
190 366	Ford	Bomba lavaparabrisas Escort, Fiesta ->'96, Focus '98->'05, Mondeo, Transit
190 367	Ford	Bomba lavaparabrisas Escort, Fiesta ->'08, Focus '98->'05, Ka, Mondeo, Puma, Transit
190 368	Ford	Bomba lavaparabrisas Galaxy '94->'00
	Opel	Bomba lavaparabrisas Astra F
	VAG	Bomba lavaparabrisas Seat Alhambra, Córdoba, Ibiza, Inca, VW Golf 3, Passat, Polo, Sharan, Transporter
190 369	Rover	Bomba lavaparabrisas Land Rover Discovery, Range Rover
190 370	Mercedes	Bomba lavaparabrisas MB 190 (W201), clase C '93->'00 (W202), clase E ->'02 (W124 / W210)
190 371	Mercedes	Bomba lavaparabrisas Mercedes clase G (W460), Sprinter, Vito
	Opel	Bomba lavaparabrisas Ascona, Astra F, Corsa A y B, Kadett, Omega, Senator, Vectra A
	VAG	Bomba lavaparabrisas VW Passat, Polo, Transporter, LT
190 372	Opel	Bomba lavaparabrisas Agila, Astra G y H, Corsa B, C y D, Meriva, Omega, Signum, Tigra, Vectra B y C, Zafira A y B
	VAG	Bomba lavaparabrisas Seat Alhambra, Ibiza '93, Inca '96, VW Caddy '96, Corrado, Golf II y III, Passat ->'04, Polo II y III, Transporter
190 373	Opel	Bomba lavaparabrisas Astra G y H (sedán), Combo, Corsa C, Omega, Tibra B, Vectra B y C (sedán), Zafira
190 374	Renault	Bomba lavaparabrisas Clio II, Espace, Kangoo '97->'03, Laguna I, Megane I, Safrane, Scenic I, Twingo I
190 375	Renault	Bomba lavaparabrisas Clio '96->'01, Espace, Kangoo '97->'03, Laguna I, Megane I, Scenic I, Twingo I
190 376	PSA	Bomba lavaparabrisas Berlingo, C2, C5, Saxo, Xsara II, Xsara Picasso, P-106, Partner
	Renault	Bomba lavaparabrisas Clio II, Kangoo, Master, Megane I, Safrane
190 377	Renault	Bomba lavaparabrisas R-19, R-21, Clio I '96->'98, Espace, Express, Kangoo, Master, Megane I, Safrane
190 378	Mercedes	Bomba lavaparabrisas Mercedes Clase B (W245), Clase C (W204)
	Mini	Bomba lavaparabrisas R55, R56, R57, R60
	VAG	Bomba lavaparabrisas Seat Alhambra, Córdoba, Ibiza, Toledo, Skoda Octavia ->'04, VW Golf, Sharan
190 379	VAG	Bomba lavaparabrisas Seat Alhambra, Córdoba, Ibiza, Inca, León, Toledo, Skoda Octavia '04->, VW Golf, Passat IV '97->'04, Sharan
	Volvo	Bomba lavaparabrisas 960, S70, V70, S90
190 380	Volvo	Bomba lavaparabrisas C70 ->'05, S40 / V40 ->'04, S60 '01->'09, S80 ->'06, V70 ->'08, XC90



INDICE REFERENCIAS

FAM. 0300	Marca	Descripción
190 382	Ford	Bomba lavafaros Galaxy '00->'06
	VAG	Bomba lavafaros - varios modelos -
190 383	Fiat	Bomba lavaparabrisas Ducato
	PSA	Bomba lavaparabrisas Citroën Jumper, Peugeot Boxer
190 384	Nissan	Bomba lavaparabrisas Almera, Maxima, Patrol, Primera, Serena, Sunny, Teana '06, Vanete, X-Trail '01, 350Z
190 385	Fiat	Bomba lavaparabrisas -varios modelos-
	PSA	Bomba lavaparabrisas Citroën C-15
190 387	Renault	Bomba lavaparabrisas R-9, R-11, R-19, R-21, Super 5
190 388	Dacia	Bomba lavaparabrisas Logan
	Nissan	Bomba lavaparabrisas Almera Tino, Qashqai, Pathfinder, Terrano II
	PSA	Bomba lavaparabrisas Berlingo, C1, C3 Pluriel, C4, C5, Jumpy, P-107, P-207, P-307, P-308, P-607, Expert
	Renault	Bomba lavaparabrisas - varios modelos -
190 389	Opel	Bomba lavaparabrisas - varios modelos -
190 501	universal	
190 502	universal	
190 503	universal	
190 504	universal	
190 505	universal	
190 506	universal	
190 507	universal	
190 508	universal	
190 509	universal	
190 510	universal	
190 511	universal	
190 512	universal	
190 513	universal	
190 514	universal	
190 515	universal	
190 516	universal	
190 517	universal	
190 518	universal	
190 519	universal	
190 520	universal	
	PSA	Rácor unión tubos lavalunas -varios modelos-
301 021	universal	
	VAG	Abrazadera 3,6 x 140 con soporte -varios modelos-
301 022	universal	
	VAG	Abrazadera 3,6 x 200 con soporte -varios modelos-
301 290	universal	
	Opel	Fijac. cable airbag Corsa C, Vectra C, fij. otros usos Astra F y G, Corsa B y D, Vectra A y B, Zafira B



INDICE REFERENCIAS

FAM. 0840	Marca	Descripción
540 001	universal	Remachadora
585 158	universal	Remache de Ø 5 x 15,8 mm
586 325	universal	Remache de Ø 6,3 x 25,2 mm
585 172	universal	Remache de Ø 5 x 17,2 mm
586 617	universal	Remache de Ø 6,6 x 17,3 mm